



IT



EN



DE



FR



RU



Catalogo  
**BB 01**

**Listino Prezzi**  
Price List



Egr. Cliente,

Le presentiamo il nuovo catalogo/listino prezzi di IVR S.p.A.

Nelle pagine di apertura troverà l'indice della nostra produzione e l'elenco delle novità.

Abbiamo affiancato a molti nostri prodotti il QR CODE per scaricare la relativa scheda tecnica.

La nostra offerta è stata raggruppata, per una consultazione più veloce del catalogo, in 6 linee di prodotto (PRODOTTI PER IL RISCALDAMENTO, SERVOCOMANDI E VALVOLE MOTORIZZATE, VALVOLE A SFERA PER ACQUA, VALVOLE PER GAS, PRODOTTI PER L'INDUSTRIA, DOMOTICA SMART).

Nella parte finale del catalogo/listino prezzi troverà la sezione del risparmio energetico.

Dear Customer,

We are glad to present our new IVR Catalogue/Price List.

On the first pages you can find the index of our product range. We have highlighted the new items introduced in this version.

Next to many of our products there are QR codes that allow you to download technical data sheets.

We have divided our range in to 6 product lines (PRODUCTS FOR HEATING, ACTUATORS AND VALVES FOR ACTUATORS, WATER, GAS, INDUSTRIAL VALVES, SMART HOME AUTOMATION).

In the final section we focus on energy saving.

Sehr geehrter Kunde,

wir freuen uns, Ihnen unser Katalog/Preisliste vorzustellen.

Die ersten Seiten enthalten ein Verzeichnis von unseren Produktfamilien. Wir haben die neuen Produkte markiert.

Neben vielen Artikeln finden Sie das QR Code, damit Sie das technische Datenblatt entladen können.

Zum einfacherem Verständnis haben wir unsere Produktpalette in 6 Familien aufgeteilt (HEIZUNGSPRODUKTE, SERVOSTEUERUNGEN UND KUGELHÄHNE FÜR SERVOSTEUERUNGEN, KUGELHÄHNE FÜR WASSER, KUGELHÄHNE FÜR GAS UND KUGELVENTILE FÜR INDUSTRIE, SMART-HOME-AUTOMATISIERUNG).

Im letzten Kapitel konzentrieren wir uns auf das Energiesparen.

Cher Client,

nous sommes heureux de Vous présenter notre nouveau Catalogue/Liste de Prix IVR S.p.A.

Aux premières pages Vous trouverez le sommaire de notre gamme de produits et la liste des produits nouveaux.

À côté de beaucoup de nos produits nous avons indiqué le CODE QR pour télécharger les fiches techniques.

Pour une meilleure compréhension nous avons partagé notre gamme de produits en 6 lignes de produits (PRODUITS PUR LE CHAUFFAGE, ACTIONNEURS ET VANNES POUR ACTIONNEURS, VANNES À BOISSEAU SPHERIQUE POUR L'EAU, VANNE À BOISSEAU SPHÉRIQUE POUR LE GAZ ET VANNES POUR L'INDUSTRIE, DOMOTIQUE INTELLIGENTE).

Aux dernières pages il y a le chapitre concernant l'économie d'énergie.

Уважаемый покупатель,

Представляем Вашему вниманию наш новый Каталог/Прайс-лист IVR S.p.A.

На первых страницах Вы найдете содержание а также перечень новых видов продукции.

К многим артикулам мы добавили QR-код для удобного просмотра соответствующих технических данных.

Для комфортного ознакомления каталог разделен на шесть частей (ОБОРУДОВАНИЕ ДЛЯ ОТОПИТЕЛЬНЫХ СИСТЕМ, ПРИВОДЫ, ЗАПОРНАЯ АРМАТУРА ДЛЯ ВОДЫ, ГАЗА И ИНДУСТРИАЛЬНАЯ ЗАПОРНАЯ АРМАТУРА, УМНАЯ ДОМАШНЯЯ АВТОМАТИЗАЦИЯ).

В заключительной части каталога / прайс-листа вы найдете раздел энергосбережения.





Il nostro Sistema Qualità Aziendale è certificato secondo UNI EN ISO 9001:2015

Our Quality System has been certified according to UNI EN ISO 9001:2015

Unser unternehmensinternes Qualitätssystem ist nach Norm UNI EN ISO 9001:2015 zertifiziert

Notre système de qualité d'entreprise est certifié selon UNI EN ISO 9001:2015

Система качества нашей продукции подтверждена сертификатом UNI EN ISO 9001:2015

I nostri prodotti sono omologati ed approvati dai principali Enti di Certificazione Internazionali

Our products have been approved by the following international standards

Unsere Produkte wurden von den wichtigsten internationalen Zertifizierungsstellen zugelassen und genehmigt

Nos produits sont certifiées et approuvées par les principaux Organismes de certification internationaux

Наша продукция проверена и одобрена ведущими сертификационными организациями







### IVR 902

Collettore in tecnopolimero premontato di mandata con misuratori di portata, valvola sfogo aria, rubinetto orientabile di carico/scarico acqua. Collettore in tecnopolimero premontato di ritorno con valvole termostattizzabili, cappellotti di regolazione, valvola sfogo aria, rubinetto orientabile di carico/scarico acqua, tappi inclusi con zanche di fissaggio in tecnopolimero.

Pre-assembled polymer supply manifold with flow meters, air vent valve, adjustable water fill / drain cock. Preassembled return manifold in polymer with thermostatic valves, adjustment caps, air vent valve, adjustable water fill / drain cock, caps and fixing brackets included.

NEW

p.3



### IVR 902 KIT A

Collettore in tecnopolimero premontato di mandata con misuratori di portata, valvola sfogo aria, rubinetto orientabile di carico/scarico acqua e valvola a sfera. Collettore in tecnopolimero premontato di ritorno con valvole termostattizzabili, cappellotti di regolazione, valvola sfogo aria, rubinetto orientabile di carico/scarico acqua e valvola a sfera, tappi inclusi con zanche di fissaggio in tecnopolimero.

Preassembled polymer supply manifold with flow meters, air vent valve, adjustable water fill / drain cock and ball valve. Preassembled return manifold in polymer with thermostatic valves, adjustment caps, air vent valve, adjustable water fill / drain tap and ball valve, caps included with fixing brackets.

NEW

p.3



### IVR 206/B R

Valvola a sfera a passaggio totale con ritegno incorporato e dado folle - attacchi F/F, farfalla blu

Full bore ball valve with check valve with swivel nut - F/F couplings, blue butterfly handle

NEW

p.25



### IVR 821 U

Staffe multifunzionali universali per collettori in ottone ed acciaio, interasse regolabile da min di 200 mm a un max di 285 mm, profondità regolabile del morsetto da max H 70 mm - mid H 58,5 mm - min H 47 mm

Universal multi-functional brackets for manifolds in brass and steel, adjustable centre distance from min of 200 mm to max di 285 mm, adjustable depth max H 70 mm - mid H 58.5 mm - min H 47 mm

NEW

p.35



NEW

p.101



NEW

p.101



NEW

p.101



NEW

p.145



NEW

p.145



NEW

p.161

### IVR 220 G

Valvola a sfera a passaggio totale motorizzabile, 2 vie, attacchi F/F - versione in ottone NON nichelata

Full bore ball valve for actuator, 2-way, F/F couplings - version in brass NOT nickel-plated

### IVR 234 G

Valvola a sfera a passaggio totale, 3 vie deviatrice, motorizzabile, attacchi F/F/F - versione in ottone NON nichelata

Full bore ball valve for actuator, 3-way, diverter, F/F/F couplings - version in brass NOT nickel-plated

### IVR 215 DIV EASY G

Servocomando per valvole deviatrici IVR 220 G e IVR 234 G - alimentazione 230 V ac 50 Hz - tempo manovra 12s/90° tipologia 2-point SPST con Cable

Actuator for diverter valves IVR 220 G and IVR 234 G - power supply 230 V ac 50 Hz - manoeuvre time 12s/90° type 2-point SPST with Cable

### IVR 760 K1

KIT Termostatico di collegamento Solare-Caldia - 3/4" - Kvs 1,2

Thermostatic KIT for Solar-Boiler connection - 3/4" - Kvs 1,2

### IVR 760 K2

KIT Termostatico di collegamento Solare-Caldia con temperatura di deviazione regolabile - 3/4" - Kvs 1,7

Solar-Boiler connection thermostatic KIT with adjustable deviation temperature - 3/4" - Kvs 1.7

### IVR 924 S

Raccoglitore di impurità a Y con rubinetto di scarico, filtro in acciaio inox AISI 304 - attacchi F/F

Y Pattern strainer with drainage valve, filter in stainless steel AISI 304 - F/F



**NEW**  
p.167

### IVR 394

Raccordo diritto per tubo multistrato  
Straight fitting for multilayer pipe



**NEW**  
p.169

### IVR 464

Raccordo a gomito per tubo multistrato con staffa  
Elbow fitting for multilayer pipe with flange



**NEW**  
p.167

### IVR 397

Raccordo ridotto diritto maschio per tubo multistrato  
Straight male size reduction fitting for multilayer pipe



**NEW**  
p.169

### IVR 466

Raccordo a gomito per tubo multistrato con staffa tipo lungo  
Elbow fitting for multilayer pipe with flange - long pattern



**NEW**  
p.167

### IVR 445

Raccordo diritto maschio per tubo multistrato  
Straight male fitting for multilayer pipe



**NEW**  
p.169

### IVR 467

Raccordo a Tee per tubo multistrato  
Tee fitting for multilayer pipe



**NEW**  
p.168

### IVR 446

Raccordo diritto femmina per tubo multistrato  
Straight female fitting for multilayer pipe



**NEW**  
p.169

### IVR 468

Raccordo a Tee ridotto per tubo multistrato  
Size Reduction Tee fitting for multilayer pipe



**NEW**  
p.168

### IVR 447

Raccordo a gomito per tubo multistrato  
Elbow fitting for multilayer pipe



**NEW**  
p.170

### IVR 469

Raccordo a Tee per tubo multistrato  
Tee fitting for multilayer pipe - Female Connection



**NEW**  
p.168

### IVR 448

Raccordo a gomito maschio per tubo multistrato  
Male elbow fitting for multilayer pipe



**NEW**  
p.170

### IVR 470

Adattatore sede conica per tubo multistrato  
Adapter with conical seat for multilayer pipe



**NEW**  
p.168

### IVR 449

Raccordo a gomito femmina per tubo multistrato  
Female elbow fitting for multilayer pipe





**NEW**  
p.217

### IVR 279

Valvole di intercettazione a saracinesca corpo piatto a cuneo gommato - attacchi flangiati PN10-16

Flat body, soft seated gate shut-off valves - flanged couplings PN10-16



**NEW**  
p.219

### IVR 286

Valvola di ritegno a flusso avviato - flangiata PN 16

Globe check valve - flanged PN 16



**NEW**  
p.217

### IVR 281

Valvola di intercettazione a flusso avviato a baderna - attacchi flangiati PN 16

Swivel globe shut-off valve - flanged couplings PN 16



**NEW**  
p.220

### IVR 287

Giunto in gomma piena EPDM - PN 10/16

Solid rubber joint EPDM - PN 10/16



**NEW**  
p.217

### IVR 288

Valvola di intercettazione a flusso avviato a soffiello - flangiata PN 16

Bellows globe shut-off valve - flanged PN 16



**NEW**  
p.229

### IVR 272 M

IVR 272 - attuatore elettrico multitemperatura a 1/4 di giro - da 24 V ac/dc a 240 V ac/dc

IVR 272 - Multi-voltage electrical quarter-turn actuators - from 24 V ac/dc to 240 V ac/dc



**NEW**  
p.218

### IVR 283

Valvola di ritegno a molla - flangiata PN 10/16

Spring check valve - flanged PN 10/16

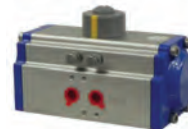

**NEW**  
p.240

### IVR 270

IVR 270 - DA - Attuatori Pneumatici rotanti - DOPPIO EFFETTO

IVR 270 - DA - Pneumatic rotary actuators - DOUBLE ACTING



**NEW**  
p.218

### IVR 284

Valvola di ritegno a palla - flangiata PN 16

Spring check valve - flanged PN 16

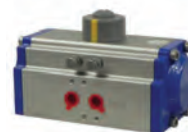

**NEW**  
p.240

### IVR 271

IVR 271 - SR - Attuatori Pneumatici rotanti - SEMPLICE EFFETTO

IVR 271 - SR - Pneumatic rotary actuators - SPRING RETURN



**NEW**  
p.218

### IVR 285

Valvola di ritegno a palla - filettata F/F

Ball check valve - threaded F/F

CODE	PAG.
20	147
20/A	147
25	148
25/A	148
42	142
42/43 R	181
43	142
45 GAS	191
45 LB	113
45 LD GAS	192
45 LD	118
45 LN	114
45 NPT	146
45 PLUS	112
45	113
45/A FB	114
45/A FN	115
45/A GAS	191
45/A NPT	146
45/A	114
46 LB	115
46 LD	118
46 LN	116
46 PLUS	113
46	115
46/A FB	116
46/A FN	117
46/A	116
47	117
47/A	117
48 TOP	111
48/A TOP	111
58	128
58/A	128
60 LB	135
60	135
60/A	135
60/B	135
62	85
64	85
68	150
68/A	150
69	150
69/A	150
70	152
71	152
72	153
73	153
77 + 180	213
77 + 270	233
77 + 271	238
77 + 272 M	222
77	213
78 + 180	214
78 + 270	234
78 + 271	239
78 + 272 M	222
78	213
80	214
81	214
82 + 180	199
82	199
83 + 180	200

CODE	PAG.
83	199
86/A	26
86/B	26
90	159
97	176
97/F	221
97/G	221
98	159
100 DIN	185
100 GW 4MS KIWA	138
100 GW 4MS	VII
100 LD	VII
100	VII
100/A DIN	VII
100/A GW 4MS	VII
100/A	187
101 GW 4MS KIWA	138
101 GW 4MS	139
101 LD	188
101	187
101/A GW 4MS	VII
101/A	VII
103	VII
105	VII
108	VII
109	39
110	196
111	196
112	196
113	197
114	VII
116	VII
117	VII
118	VII
120 GW 4MS	VII
121 GW 4MS	141
129	155
130 P	176
130 R	180
130	157
134 R	VII
134	VII
135 R	VII
135	VII
136/A	VII
137 GW 4MS	140
137 R	180
137	151
140	162
144 L + 218	228
144 L + 270	VII
144 L + 271	VII
144 L + 272 M	VII
144 L	VII
145 T + 218	VII
145 T + 270	232
145 T + 271	237
145 T + 272 M	226
145 T	209
149	86
150	VII
151	VII
151/A	VII

CODE	PAG.
152	VII
152/A	VII
157 GW 4MS	141
161	198
162	198
170	219
172 C	242
172 G	VII
172	VII
174	VII
175 + 270	VII
175 + 271	VII
175 + 272 M	223
175	215
176 + 270	235
176 + 271	240
176 + 272 M	223
176	VII
177	VII
178	VII
179	VII
180	VII
182	188
183	188
190	189
190/A	189
191	189
191/A	VII
193	VII
194	VII
200	VII
205/A	VII
205/B	25
206/A	24
206/B R	<b>NEW</b> 25
206/B	24
208 GW 4MS KIWA	138
208 GW 4MS	VII
208/A GW 4MS	VII
212	VII
212/A	VII
215 B	VII
215 D	108
215 DIV EASY G	<b>NEW</b> 101
215 DIV EASY	108
215 MIX EASY	107
215 UB	99
217 3P	VII
218 3P	VII
218 DIV	VII
218 MIX	VII
218 UNI DIV	VII
218 UNIMIX	104
220 + 215	92
220 G	<b>NEW</b> 101
220	96
221 + 215	92
221	VII
222 + 215	VII
222	VII
223 + 215	VII
223	VII
230 + 217	92



CODE	PAG.	CODE	PAG.	CODE	PAG.
230	96	312 P	171	414	VIII
234 + 215	94	312 PN	VIII	415	VIII
234 G	<b>NEW</b> 101	315 C	VIII	416	VIII
234	97	315 CN	VIII	417	46
235 + 215	93	315 P	VIII	420	174
235	97	315 PN	VIII	426	175
236 + 215	94	316	34	427	175
236	97	319	81	435	74
237 + 215	94	320	173	436	VIII
237	98	321	173	440	VIII
240 + 215	95	324	87	440/A	VIII
240	98	325	VIII	441	VIII
241 + 215	95	326	VIII	441/A	VIII
241	98	327	VIII	442	144
242 + 215	95	330	VIII	443	144
242	98	330/C	VIII	445	<b>NEW</b> 167
245 MIX EASY + 215 MIX EASY	106	332	87	446	<b>NEW</b> 168
245 MIX EASY	106	334	77	447	<b>NEW</b> 168
246 + 218 MIX	103	335	80	448	<b>NEW</b> VIII
246	104	336	77	449	<b>NEW</b> VIII
247 + 218 MIX	103	340	78	456	VIII
247	104	341	VIII	457	VIII
248 + 218 DIV	105	342	VIII	458	VIII
248	105	344 C	VIII	459	86
249 DIV EASY + 215 DIV EASY	107	344	VIII	462	45
249 DIV EASY	107	346	VIII	463	45
256 BL	177	347	83	464	<b>NEW</b> 169
256 RO	177	348	80	466	<b>NEW</b> 169
257	202	350	83	467	<b>NEW</b> VIII
270	<b>NEW</b> 240	351	83	468	<b>NEW</b> VIII
271	<b>NEW</b> 240	352 L	84	469	<b>NEW</b> VIII
272 M	<b>NEW</b> 229	352	VIII	470	<b>NEW</b> VIII
275 CF8M	215	355	VIII	530 AD	VIII
276 CF8M + 270	234	356	VIII	530	62
276 CF8M + 271	VIII	357	VIII	534	67
276 CF8M + 272 M	VIII	358	VIII	534/2	67
276 CF8M	VIII	359	176	535	68
277 CF8M	VIII	360	20	535/2	68
278 CF8M	VIII	361	20	536	VIII
279	<b>NEW</b> 217	364	21	536/2	VIII
281	<b>NEW</b> 217	367	21	537	VIII
282	216	369	VIII	537/2	VIII
283	<b>NEW</b> 218	380	VIII	538	VIII
284	<b>NEW</b> 218	381	VIII	538/2	70
285	<b>NEW</b> VIII	382	VIII	539	71
286	<b>NEW</b> VIII	394	<b>NEW</b> VIII	539/2	71
287	<b>NEW</b> VIII	397	<b>NEW</b> 167	540	70
288	<b>NEW</b> VIII	398	166	540/2	70
297	VIII	399	166	541	VIII
298	156	403	174	541/2	VIII
300	165	405	33	547	VIII
302	164	406	VIII	547/2	VIII
303	165	407	VIII	549	VIII
304	164	408	VIII	549/2	69
305	VIII	408/1 K	VIII	551 CHR	50
306	VIII	408/2 K	VIII	551	63
307	VIII	408/3 K	31	551/2	63
308	VIII	408/4 K	31	553 CHR	49
310 C	VIII	408/5 K	31	553	VIII
310 CN	172	408/6 K	31	553/2	VIII
310 P	171	408/7 K	31	555 CHR	VIII
310 PN	171	411	VIII	555	VIII
311	34	412	VIII	555/2	VIII

CODE	PAG.	CODE	PAG.	CODE	PAG.
557 CHR	47	596	88	755	72
557	64	597 CHR	47	756	72
557/2	64	597	IX	758	72
560 CHR	49	599	IX	759	145
560	55	600	IX	760 K1	<b>NEW</b> 145
560/2	55	605	IX	760 K2	<b>NEW</b> 145
560/3	55	620	IX	760	145
560/4	55	654	212	773 CHR	49
561 CHR	49	655	211	774 CHR	48
561	52	656	211	776 CHR	48
561/2	52	657	212	777 CHR	47
561/3	52	660	207	795	241
561/4	52	662 + 270	IX	796	241
562 CHR	48	662 + 271	IX	797	241
562	60	662 + 272 M	IX	800	7
562/2	60	662	IX	801	7
562/3	60	663 + 270	IX	802 KIT A	4
562/4	60	663 + 271	236	802 KIT B	5
563 CHR	47	663 + 272 M	224	802	8
563	57	663	208	803 KIT A	6
563/2	57	664 + 270	233	803	8
563/3	57	664 + 271	238	804 KIT A	6
563/4	57	664 + 272 M	IX	804	9
566 KIT	65	664	IX	805	9
566	56	665 + 218	IX	806	10
566/2	56	665 + 270	IX	807	10
566/3	56	665 + 271	IX	809/A	27
566/4	56	665 + 272 M	224	809/B	27
567 KIT	65	665	208	814	11
567	53	667	210	816	20
567/2	53	668 + 270	233	820	26
567/3	53	668 + 271	238	821 U	<b>NEW</b> 35
567/4	53	668 + 272 M	227	821	35
568 KIT	66	668	211	822	35
568	61	670 + 218	227	823	29
568/2	61	670 + 270	231	824	29
568/3	61	670 + 271	236	825 D	30
568/4	61	670 + 272 M	225	825	30
569 KIT	65	670	208	827/A	25
569	58	672 + 218	228	827/B	25
569/2	58	672 + 270	231	829	87
569/3	58	672 + 271	236	830	36
569/4	58	672 + 272 M	225	831	36
570 KIT	66	672	209	832	20
570	54	685 + 218	229	833	21
570/2	54	685 + 270	232	836	32
570/3	54	685 + 271	237	836/I	32
570/4	54	685 + 272 M	226	836/P	32
571 KIT	66	685	210	837	21
571	59	687	212	838	21
571/2	59	696	220	840	35
571/3	59	697	220	844	46
571/4	59	711	37	847 A	32
580 CHR	50	712	37	847 C	33
580	73	714	37	847 I	46
581 CHR	50	714/R	38	858	19
581	73	718	82	867	17
586	88	718/C	82	868	16
587	88	748	76	869	16
588	88	749	76	871	15
590	88	750	76	872	18
591	51	753	72	873	18
594	88	754	72	875 CS	11



CODE	PAG.
875	12
877 CS	12
877	13
878 CS	13
878	14
879 CS	14
879	15
882	42
883	43
884	44
893	44
897	32
902 KIT A	<b>NEW</b> 3
902	<b>NEW</b> 3
904	85
905	85
909	75
918 LB	130
918 LN	130
918	130
918/A FB	131
918/A FN	131
918/A	131
919 LB	132
919 LN	132
919	132
919/A FB	133
919/A FN	133
919/A	133
920	134
920/A	134
923	160
924 C	182
924 S	<b>NEW</b> 161
924	161
925	155
926	155
927	155
928	155
944 AS	27
954 LB	121
954 LD	127
954 LN	121
954 PLUS	120
954 S	27
954	121
954/A FB	122
954/A FN	122
954/A	122
954/P	127
956 LB	123
956 LD	127
956 LN	123
956 PLUS	120
956	123
956/A FB	124
956/A FN	124
956/A	124
957 LB	125
957 LN	125
957 PLUS	120
957	125
957/A FB	126

CODE	PAG.
957/A FN	126
957/A	126
961/A	136
961/B	136
962	154
966 R	181
966	154
966/A	154
979/A	28
979/B	28
980/A	23
980/B	23
981/A	23
981/B	23
982/A	24
982/B	24
984/A	22
984/B	22
985	26
986/A	22
986/B	22
991	81
992	151
993 TG	158
993 TM	158
994	158
995 L	159
999 H	160
999 L	160
CAPPUCCIO GIALLO	202
CAPPUCCIO VERDE	179
DADO ACCIAIO	182
DADO INOX	182
FARFALLA ALL. ARANCIO	180
FARFALLA ALL. AZZURRA	177
FARFALLA ALL. GIALLA	202
FARFALLA ALL. NERA	177
FARFALLA ALL. ROSSA	178
FARFALLA ALL. VERDE	179
GUA 77/78	243
GUA 80/81	243
GUA 82/83	203
LEVA ACC ARANCIO	180
LEVA ACC GIALLA	202
LEVA ACC. AZZURRA	178
LEVA ACC. NERA	178
LEVA ACC. ROSSA	178
LEVA ACC. VERDE	179
LEVA ACCIAIO GIALLA ART 82-83	203
LEVA ACCIAIO NERA ART 77-78	242
LEVA ALL. NERA	179
LEVA GIALLA WAFER LUG	203
LEVA IMBUTITA ROSSA	242
LEVA NERA WAFER LUG	242
MANIGLIA RIDUTT. VERDE	179
VITI ACCIAIO	203



## **RISCALDAMENTO**

HEATING  
HEIZUNG  
CHAUFFAGE  
ОТОПЛЕНИЕ



## **SERVOCOMANDI E VALVOLE MOTORIZZABILI**

ACTUATORS AND MOTORIZED VALVES  
SERVOSTEUERUNGEN UND MOTORISIERBARE KUGELHÄHNE  
SERVOCOMMANDES ET VANNES MOTORISABLES  
СЕРВОПРИВОДЫ И КЛАПАНЫ



## **VALVOLE ACQUA**

WATER VALVES  
KUGELHÄHNE FÜR WASSER  
VANNES EAU  
КЛАПАНЫ ДЛЯ ВОДЫ



## **VALVOLE GAS**

GAS VALVES  
GASKUGELHÄHNE  
VANNES GAZ  
КЛАПАНЫ ДЛЯ ГАЗА



## **VALVOLE INDUSTRIA**

INDUSTRIAL VALVES  
INDUSTRIEKUGELHÄHNE - VENTILE UND ARMATUREN  
VANNES INDUSTRIE  
ИНДУСТРИАЛЬНАЯ ЗАПОРНАЯ АРМАТУРА



## **DOMOTICA SMART**

SMART HOME AUTOMATION  
SMART-HOME-AUTOMATISIERUNG  
DOMOTIQUE INTELLIGENTE  
УМНАЯ ДОМАШНЯЯ АВТОМАТИЗАЦИЯ





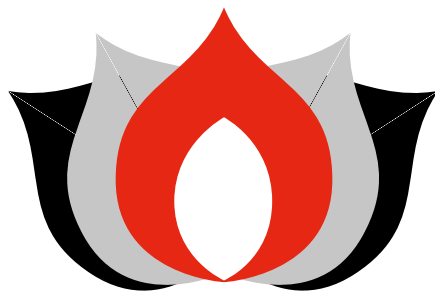

**RISCALDAMENTO**  
**HEATING**  
**HEIZUNG**  
**CHAUFFAGE**  
**ОБОРУДОВАНИЕ ДЛЯ СИСТЕМ ОТОПЛЕНИЯ**







<b>COLLETTORI TECNOPOLIMERO</b> <i>POLYMER MANIFOLDS</i>	p. 3	<b>DETENTORI - ATTACCO FERRO</b> <i>LOCKSHIELDS - IRON CONNECTION</i>	p. 63
<b>COLLETTORI INOX - AVANT FLOOR</b> <i>INOX MANIFOLDS - AVANT FLOOR</i>	p. 4	<b>DETENTORI - ATTACCO PEX-RAME</b> <i>LOCKSHIELDS - PEX-COPPER CONNECTION</i>	p. 64
<b>COLLETTORI IN OTTONE</b> <i>BRASS MANIFOLDS</i>	p. 18	<b>KIT TERMOSTATICI</b> <i>THERMOSTATIC KITS</i>	p. 65
<b>VALVOLE SFOGO ARIA</b> <i>AIR-VENT VALVES</i>	p. 20	<b>VALVOLE MANUALI - ATTACCO FERRO</b> <i>MANUAL VALVES - IRON CONNECTION</i>	p. 67
<b>VALVOLE BOCCHETTONE PER COLLETTORI</b> <i>VALVES WITH TAIL PIECE FOR MANIFOLDS</i>	p. 22	<b>DETENTORI - ATTACCO FERRO</b> <i>LOCKSHIELD - IRON CONNECTION</i>	p. 68
<b>VALVOLE PORTASONDA PER COLLETTORI</b> <i>VALVE WITH SENSOR CONNECTION FOR MANIFOLDS</i>	p. 27	<b>VALVOLE MANUALI - ATTACCO PEX-RAME</b> <i>MANUAL VALVES - PEX-COPPER CONNECTION</i>	p. 70
<b>TESTA TERMoeLETRICA THERMO SUNNY</b> <i>THERMOELECTRIC ACTUATOR THERMO SUNNY</i>	p. 29	<b>DETENTORI - ATTACCO PEX-RAME</b> <i>LOCKSHIELD - PEX-COPPER CONNECTION</i>	p. 71
<b>ACCESSORI PER COLLETTORI</b> <i>ACCESSORIES FOR MANIFOLDS</i>	p. 30	<b>VALVOLE AD H</b> <i>H VALVES</i>	p. 72
<b>IVR MULTIKLIMA - MISCELAZIONE</b> <i>IVR MULTIKLIMA - MIXING UNIT</i>	p. 37	<b>ADATTATORI</b> <i>ADAPTERS</i>	p. 73
<b>IVR VALVOLE ATTACCO POMPA</b> <i>IVR VALVES WITH PUMP CONNECTION</i>	p. 38	<b>KIT PER RADIATORI</b> <i>KIT FOR RADIATORS</i>	p. 74
<b>COLLETTORI PREMONTATI</b> <i>CON MISCELAZIONE</i>	p. 40	<b>DEFANGATORE MAGNETICO</b> <i>MAGNETIC DIRT SEPARATOR</i>	p. 75
<b>COLLETTORI INDUSTRIALI - INOX</b> <i>INDUSTRIAL MANIFOLDS - INOX</i>	p. 42	<b>VALVOLE FAN-COIL</b> <i>FAN-COIL VALVES</i>	p. 76
<b>ACCESSORI COLLETTORI INDUSTRIALI</b> <i>ACCESSORIES FOR INDUSTRIAL MANIFOLDS</i>	p. 46	<b>GRUPPO ALIMENTAZIONE</b> <i>AUTOMATIC FILLING UNIT</i>	p. 77
<b>VALVOLE TERMOSTATICHE - THERMOCHROME</b> <i>THERMOSTATIC VALVES - THERMOCHROME</i>	p. 47	<b>VALVOLE DI BILANCIAMENTO</b> <i>BALANCING VALVES</i>	p. 78
<b>TESTE TERMOSTATICHE</b> <i>THERMOSTATIC HEADS</i>	p. 51	<b>VALVOLE DI SICUREZZA E SCARICO CALDAIA</b> <i>SAFETY VALVES</i>	p. 82
<b>VALVOLE TERMOSTATICHE - ATTACCO FERRO</b> <i>THERMOSTATIC VALVES - IRON CONNECTION</i>	p. 52	<b>ACCESSORI PER VALVOLE TERMOSTATICHE</b> <i>ACCESSORIES FOR THERMOSTATIC VALVES</i>	p. 86
<b>VALVOLE TERMOSTATICHE - ATTACCO PEX-RAME</b> <i>THERMOSTATIC VALVES - PEX-COPPER CONNECTION</i>	p. 57	<b>RICAMBI PER LINEA RISCALDAMENTO</b> <i>SPARE PARTS FOR HEATING LINE</i>	p. 87
<b>VALVOLE TERMOSTATICHE COASSIALI</b> <i>THERMOSTATIC COAXIAL VALVES</i>	p. 62		

## COLLETTORI TECNOPOLIMERO POLYMER MANIFOLDS

### IVR 902

NEW



Collettore in tecnopolimero premontato di mandata con misuratori di portata, valvola sfogo aria, rubinetto orientabile di carico/scarico acqua. Collettore in tecnopolimero premontato di ritorno con valvole termostattizzabili, cappellotti di regolazione, valvola sfogo aria, rubinetto orientabile di carico/scarico acqua, tappi inclusi con zanche di fissaggio in tecnopolimero.

Pre-assembled polymer supply manifold with flow meters, air vent valve, adjustable water fill / drain cock. Preassembled return manifold in polymer with thermostatic valves, adjustment caps, air vent valve, adjustable water fill / drain cock, caps and fixing brackets included.

Vormontierter Vorlaufverteiler aus Polymer mit Durchflussmessern, Entlüftungsventil, Füll und Entleerungsventil. Vormontierter Rücklaufverteiler aus Polymer mit thermostatisierbaren Ventilen, Regelkappen, Entlüftungsventil, Füll und Entleerungsventil. Das Set enthält Polymerstecker und -halterungen.

Collecteur de départ pré-assemblé en polymère avec débitmètres, purgeur, robinet de remplissage / vidange. Collecteur de retour prémonté en polymère avec vannes motorisables, capuchons de régulation, purgeur, robinet de remplissage / vidange. L'ensemble comprend des bouchons et un paire de support en polymère.

Предварительно собранный коллектор подачи из технополимера с расходомерами, воздушным клапаном, регулируемым краном для заполнения и слива воды. Предварительно собранный обратный коллектор из технополимера с термостатическими клапанами, регулировочными крышками, воздушным клапаном, регулируемым краном для наполнения / слива воды, крышками с крепежными скобами из технополимера.

Cod./Code	Mis./Size	Vie/Ways	L (mm)	H (mm)	Att./Conn.	□/田	€
190222502	1"	2	210	210	3/4" EK	1	239,51
190222503	1"	3	260	210	3/4" EK	1	286,11
190222504	1"	4	310	210	3/4" EK	1	332,69
190222505	1"	5	360	210	3/4" EK	1	380,00
190222506	1"	6	410	210	3/4" EK	1	426,58
190222507	1"	7	460	210	3/4" EK	1	473,17
190222508	1"	8	510	210	3/4" EK	1	519,76
190222509	1"	9	560	210	3/4" EK	1	565,91
190222510	1"	10	610	210	3/4" EK	1	612,61
190222511	1"	11	660	210	3/4" EK	1	659,20
190222512	1"	12	710	210	3/4" EK	1	705,79



### IVR 902 KIT A

NEW



Collettore in tecnopolimero premontato di mandata con misuratori di portata, valvola sfogo aria, rubinetto orientabile di carico/scarico acqua e valvola a sfera. Collettore in tecnopolimero premontato di ritorno con valvole termostattizzabili, cappellotti di regolazione, valvola sfogo aria, rubinetto orientabile di carico/scarico acqua e valvola a sfera, tappi inclusi con zanche di fissaggio in tecnopolimero.

Preassembled polymer supply manifold with flow meters, air vent valve, adjustable water fill / drain cock and ball valve. Preassembled return manifold in polymer with thermostatic valves, adjustment caps, air vent valve, adjustable water fill / drain tap and ball valve, caps included with fixing brackets.

Vormontierter Vorlaufverteiler aus Polymer mit Durchflussmessern, Entlüftungsventil, Füll und Entleerungsventil und Absperrkugelhahn aus Messing. Vormontierter Rücklaufverteiler aus Polymer mit thermostatisierbaren Ventilen, Regelkappen, Entlüftungsventil, Füll und Entleerungsventil und Absperrkugelhahn aus Messing. Das Set enthält Polymerstecker und -halterungen.

Collecteur de départ pré-assemblé en polymère avec débitmètres, purgeur, robinet de remplissage / vidange et vanne d'arrêt à bille en laiton. Collecteur de retour prémonté en polymère avec vannes motorisables, capuchons de régulation, purgeur, robinet de remplissage / vidange et vanne d'arrêt à bille en laiton. L'ensemble comprend des bouchons et un paire de support en polymère.

Предварительно собранный коллектор подачи из технополимера с расходомерами, воздушным клапаном, регулируемым краном для наполнения / слива воды и шаровым краном. Предварительно собранный обратный коллектор из технополимера с термостатическими клапанами, регулировочными крышками, воздушным клапаном, регулируемым краном для наполнения / слива воды и шаровым клапаном, крышки с крепежными скобами из технополимера.

Cod./Code	Mis./Size	Vie/Ways	L (mm)	H (mm)	Att./Conn.	□/田	€
1902A22502	1"	2	265	210	3/4" EK	1	259,43
1902A22503	1"	3	315	210	3/4" EK	1	306,04
1902A22504	1"	4	365	210	3/4" EK	1	352,62
1902A22505	1"	5	415	210	3/4" EK	1	399,91
1902A22506	1"	6	465	210	3/4" EK	1	446,50
1902A22507	1"	7	515	210	3/4" EK	1	493,09
1902A22508	1"	8	565	210	3/4" EK	1	539,67
1902A22509	1"	9	615	210	3/4" EK	1	585,94
1902A22510	1"	10	665	210	3/4" EK	1	632,54
1902A22511	1"	11	715	210	3/4" EK	1	679,12
1902A22512	1"	12	765	210	3/4" EK	1	725,70



## COLLETTORI INOX - AVANT FLOOR INOX MANIFOLDS - AVANT FLOOR

### IVR 802 KIT A

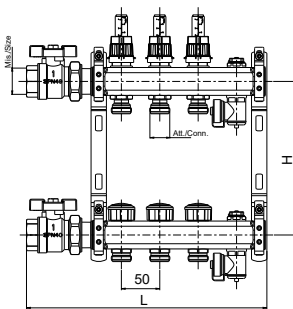

Collettore di mandata con misuratori di portata, valvola sfogo aria, rubinetto di carico/scarico acqua e valvola a sfera. Collettore di ritorno con valvole termostattizzabili, cappellotti di regolazione, valvola sfogo aria, rubinetto di carico/scarico acqua e valvola a sfera, tappi inclusi con zanche di fissaggio

Inlet manifold with flow meters and water fill/drain valve shut off ball valve. Return manifold includes shut off ball valve, thermostatic valve with adjustment cap and water fill/drain valve. Plugs and mounting brackets included

Vorlaufverteiler mit Durchflussmesser und Wasserfüll- / Ablasshahn und Kugelhahn; Rücklaufverteiler mit thermostatisierbaren Ventilen mit Einstellkappe und Wasserfüll- / Ablasshahn und Kugelhahn, inklusive Stopfen und Halterungen

Collecteur de départ avec mesureurs de débit et robinet de charge/décharge et vanne à bille ; collecteur de retour avec vanne motorisables avec bouton de réglage et robinet de charge/décharge eau et vanne à bille, bouchons et paire de support inclus

Подающий коллектор с расходомерами, краном для заливания/слива воды и шаровым клапаном; обратный коллектор с термостатическим клапаном с регулирующей крышкой, дренажным краном и шаровым клапаном, в комплекте с заглушками и скобами

Cod./Code	Mis./Size	Vie/Ways	L (mm)	H (mm)	Att./Conn.	□/田	€
1802A22502	1"	2	263	200	3/4" EK	1	172,91
1802A22503	1"	3	313	200	3/4" EK	1	204,79
1802A22504	1"	4	363	200	3/4" EK	1	236,98
1802A22505	1"	5	413	200	3/4" EK	1	268,53
1802A22506	1"	6	463	200	3/4" EK	1	300,10
1802A22507	1"	7	513	200	3/4" EK	1	332,29
1802A22508	1"	8	563	200	3/4" EK	1	364,29
1802A22509	1"	9	613	200	3/4" EK	1	392,05
1802A22510	1"	10	663	200	3/4" EK	1	424,98
1802A22511	1"	11	713	200	3/4" EK	1	456,24
1802A22512	1"	12	763	200	3/4" EK	1	487,39
1802A32506	1"1/4	6	476	200	3/4" EK	1	374,55
1802A32507	1"1/4	7	526	200	3/4" EK	1	409,53
1802A32508	1"1/4	8	576	200	3/4" EK	1	444,01
1802A32509	1"1/4	9	626	200	3/4" EK	1	479,71
1802A32510	1"1/4	10	676	200	3/4" EK	1	514,69
1802A32511	1"1/4	11	726	200	3/4" EK	1	549,08
1802A32512	1"1/4	12	776	200	3/4" EK	1	583,55





## IVR 802 KIT B

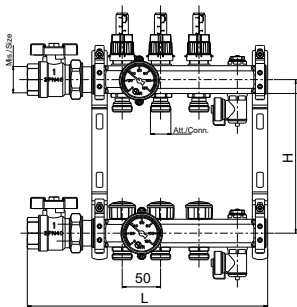

Collettore di mandata con misuratori di portata, valvola sfogo aria, rubinetto di carico/scarico acqua e valvola a sfera. Collettore di ritorno con valvole termostattizzabili, cappellotti di regolazione, valvola sfogo aria, rubinetto di carico/scarico acqua e valvola a sfera, tappi inclusi con zanche di fissaggio e termometro a contatto

Inlet manifold with flow meters, air vent, fill/drain valve and ball valve. Return manifold with thermostatic valves, operating plastic caps, air vent, fill/drain valve and shut off ball valve; plugs, mounting brackets and contact thermometer included

Vorlaufverteiler mit Durchflussmessern, Luftablassventil und Ein-/Ablasseventil, Ein-/Ablasseventil und Kugelhahn. Rücklaufverteiler mit thermostatisierbaren Ventilen, Einstellkappen und Kugelhahn; Stopfen, Befestigungsklammern und Kontaktthermometer inklusive

Collecteur de départ avec mesureurs de débit, vanne de purge de l'air, robinet de chargement/déchargement et vanne à boisseau sphérique. Collecteur de retour avec vannes thermostatisables, chapeaux de réglage, robinet de chargement/déchargement et vanne à boisseau sphérique; bouchons, plaques d'ancrage et thermomètre à contact inclus

Подающий коллектор с расходомерами, воздухоотводчиком, дренажным краном, шаровым краном. Обратный коллектор с термостатическими клапанами и регулируемыми колпачками, воздухоотводчиком, дренажным краном и шаровым краном. В комплекте с заглушками для коллектора, кронштейнами и контактным термометром.

Cod./Code	Mis./Size	Vie/Ways	L (mm)	H (mm)	Att./Conn.	□/田	€
1802B22602	1"	2	263	200	3/4" EK	1	186,37
1802B22603	1"	3	313	200	3/4" EK	1	218,19
1802B22604	1"	4	363	200	3/4" EK	1	249,35
1802B22605	1"	5	413	200	3/4" EK	1	281,07
1802B22606	1"	6	463	200	3/4" EK	1	312,30
1802B22607	1"	7	513	200	3/4" EK	1	343,96
1802B22608	1"	8	563	200	3/4" EK	1	375,19
1802B22609	1"	9	613	200	3/4" EK	1	402,67
1802B22610	1"	10	663	200	3/4" EK	1	433,82
1802B22611	1"	11	713	200	3/4" EK	1	464,74
1802B22612	1"	12	763	200	3/4" EK	1	495,58
1802B32606	1"1/4	6	476	200	3/4" EK	1	390,34
1802B32607	1"1/4	7	526	200	3/4" EK	1	425,43
1802B32608	1"1/4	8	576	200	3/4" EK	1	460,12
1802B32609	1"1/4	9	626	200	3/4" EK	1	495,20
1802B32610	1"1/4	10	676	200	3/4" EK	1	530,27
1802B32611	1"1/4	11	726	200	3/4" EK	1	565,07
1802B32612	1"1/4	12	776	200	3/4" EK	1	599,86



## IVR 803 KIT A

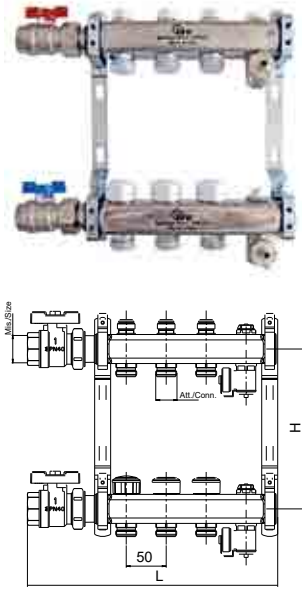

Collettore di mandata con detentori micrometrici, valvola sfogo aria, rubinetto di carico/scarico acqua, valvola a sfera. Collettore di ritorno con valvole termostattizzabili e cappellotti di regolazione, valvola sfogo aria, rubinetto di carico/scarico acqua e valvola a sfera. Tappi e zanche di fissaggio incluse.

Inlet manifolds with regulating lockshields, air vent, fill/drain valve, shut off ball valve. Return manifold with thermostatic valves and operating caps, air vent, fill/drain valve and shut off ball valve. Caps and brackets included.

Vorlaufverteiler mit mikrometrischen Rücklaufverschraubungen, Luftablassventil, Ein-/Ablassventil. Rücklaufverteiler mit thermostatisierbaren Ventilen, und Einstellkappen, Luftablassventil, Ein-/Ablassventil und Kugelhahn. Deckeln und Befestigungsklammern inklusive.

Collecteur de départ avec coudes de réglage micrométriques, vanne de purge de l'air, robinet de chargement/déchargement, vanne à boisseau sphérique. Collecteur de retour avec vannes thermostatiques coudes de réglage micrométriques, vanne de purge de l'air, robinet de chargement/déchargement, vanne à boisseau sphérique. Bouchons et plaques d'ancrages inclus.

Подающий коллектор с микрометрическими отсекающими клапанами, воздухоотводчиком, краном выпуск-выпуск и шаровым краном. Обратный коллектор с термостатическими клапанами и регулируемыми колпачками, воздухоотводчиком и дренажным клапаном. Заглушки и кронштейны в комплекте.

Cod./Code	Mis./Size	Vie/Ways	L (mm)	H (mm)	Att./Conn.	□/田	€
1803A22502	1"	2	263	200	3/4" EK	1	158,37
1803A22503	1"	3	313	200	3/4" EK	1	183,28
1803A22504	1"	4	363	200	3/4" EK	1	207,90
1803A22505	1"	5	413	200	3/4" EK	1	232,49
1803A22506	1"	6	463	200	3/4" EK	1	257,10
1803A22507	1"	7	513	200	3/4" EK	1	282,14
1803A22508	1"	8	563	200	3/4" EK	1	306,74
1803A22509	1"	9	613	200	3/4" EK	1	327,52
1803A22510	1"	10	663	200	3/4" EK	1	352,89
1803A22511	1"	11	713	200	3/4" EK	1	377,17
1803A22512	1"	12	763	200	3/4" EK	1	401,36
1803A32506	1"1/4	6	476	200	3/4" EK	1	326,47
1803A32507	1"1/4	7	526	200	3/4" EK	1	353,05
1803A32508	1"1/4	8	576	200	3/4" EK	1	379,72
1803A32509	1"1/4	9	626	200	3/4" EK	1	407,59
1803A32510	1"1/4	10	676	200	3/4" EK	1	434,17
1803A32511	1"1/4	11	726	200	3/4" EK	1	460,75
1803A32512	1"1/4	12	776	200	3/4" EK	1	486,23



## IVR 804 KIT A



Collettore di mandata con misuratori di portata e rubinetto di carico/scarico acqua e valvola a sfera; collettore di ritorno con valvole termostattizzabili con cappellotto di regolazione e rubinetto di carico/scarico acqua e valvola a sfera, tappi e zanche incluse

Inlet manifold with flow meters and fill/drain; outlet manifold with thermostatic valves with operating plastic cap and fill/drain valve, plugs and mounting brackets included.

Vorlaufverteiler mit Durchflussmeter und Ein-/Ablassventil; Rücklaufverteiler mit thermostatisierbaren Ventilen mit Einstellkappe und Ein-/Ablassventil, komplett mit Kappen und Befestigungsklammern

Collecteur d'alimentation avec mesureur de débit et robinet de chargement/déchargement; collecteur de retour avec vannes thermostatisables avec chapeau de réglage e robinet de chargement/déchargement, bouchons et plaques d'ancrages inclus

Подающий коллектор с расходомерами и дренажным краном. Обратный коллектор с термостатическими клапанами и регулируемыми колпачками, кран выпуск-выпуск. Заглушки и кронштейны в комплекте.

Cod./Code	Mis./Size	Vie/Ways	L (mm)	H (mm)	Att./Conn.	□/田	€
1804R22502	1"	2	255	200	3/4" EK	1	160,22
1804R22503	1"	3	305	200	3/4" EK	1	190,94
1804R22504	1"	4	355	200	3/4" EK	1	221,84
1804R22505	1"	5	405	200	3/4" EK	1	252,53
1804R22506	1"	6	455	200	3/4" EK	1	281,10
1804R22507	1"	7	505	200	3/4" EK	1	311,43
1804R22508	1"	8	555	200	3/4" EK	1	341,53
1804R22509	1"	9	605	200	3/4" EK	1	371,58
1804R22510	1"	10	655	200	3/4" EK	1	398,16
1804R22511	1"	11	705	200	3/4" EK	1	427,90
1804R22512	1"	12	755	200	3/4" EK	1	457,70
1804R22513	1"	13	805	200	3/4" EK	1	487,73

## IVR 800

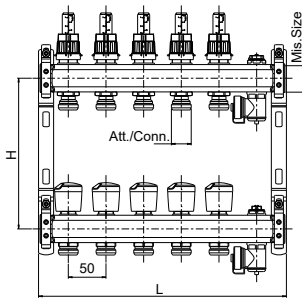

Collettore di mandata con misuratori di portata, valvola sfogo aria e rubinetto di carico/scarico acqua. Collettore di ritorno con valvole manuali con volantino, valvola sfogo aria e rubinetto di carico/scarico acqua, tappi e zanche di fissaggio incluse

Inlet manifold with flow meters, air vent and fill/drain valve. Return manifold with manual valves with handles, air vent and fill/drain valve, plugs and mounting brackets included.

Vorlaufverteiler mit Durchflussmessern, Entlüftungsventil und Füll- und Entleerungshahn. Rücklaufverteiler mit Ventilen mit Handrädern, Luftablassventil und Ein-/Ablassventil, komplett mit Kappen und Befestigungsklammern  
Collecteur de départ avec mesureurs de débits, vanne de purge de l'air et robinets de chargement/déchargement.  
Collecteur de retour avec vannes manuelles avec volant, vanne de purge de l'air, bouchons et plaques d'ancrage inclus

Подающий коллектор с расходомерами, воздухоотводчиком и дренажным краном. Обратный коллектор с ручными регулирующими клапанами, воздухоотводчиком, дренажным краном и заглушками. В комплекте с кронштейнами

Cod./Code	Mis./Size	Vie/Ways	L (mm)	H (mm)	Att./Conn.	□/田	€
180022502	1"	2	180	200	3/4" EK	1	120,70
180022503	1"	3	230	200	3/4" EK	1	153,01
180022504	1"	4	280	200	3/4" EK	1	186,56
180022505	1"	5	330	200	3/4" EK	1	218,89
180022506	1"	6	380	200	3/4" EK	1	251,52
180022507	1"	7	430	200	3/4" EK	1	285,09
180022508	1"	8	480	200	3/4" EK	1	317,41
180022509	1"	9	530	200	3/4" EK	1	345,90
180022510	1"	10	580	200	3/4" EK	1	379,51
180022511	1"	11	630	200	3/4" EK	1	411,51
180022512	1"	12	680	200	3/4" EK	1	443,40
180032506	1 1/4"	6	380	200	3/4" EK	1	280,46
180032507	1 1/4"	7	430	200	3/4" EK	1	316,82
180032508	1 1/4"	8	480	200	3/4" EK	1	352,06
180032509	1 1/4"	9	530	200	3/4" EK	1	387,30
180032510	1 1/4"	10	580	200	3/4" EK	1	424,12
180032511	1 1/4"	11	630	200	3/4" EK	1	459,26
180032512	1 1/4"	12	680	200	3/4" EK	1	494,49



## IVR 801

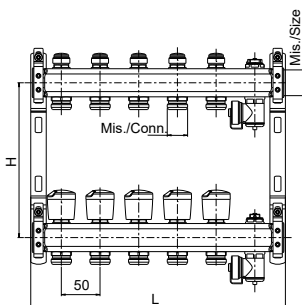

Collettore di mandata con detentori micrometrici, valvola sfogo aria e rubinetto di carico/scarico acqua. Collettore di ritorno con valvole manuali con volantino, valvola sfogo aria e rubinetto di carico/scarico acqua, tappi e zanche di fissaggio incluse

Inlet manifold with micrometric lockshields, air vent and fill/drain valve valve. Return manifold with manual valves with handles, air vent and fill/drain valve, plugs and mounting brackets included.

Vorlaufverteiler mit mikrometrischen Rücklaufverschraubungen, Luftablassventil und Ein-/Ablassventil.  
Rücklaufverteiler mit Ventilen mit Handrädern, Luftablassventil und Ein-/Ablassventil, komplett mit Kappen und Befestigungsklammern

Collecteur de départ avec coude de réglage micrométriques, vanne de purge de l'air et robinet de chargement/déchargement. Collecteur de retour avec vannes manuelles, vanne de purge de l'air, bouchons et plaques d'ancrage inclus

Подающий коллектор с микрометрическими отсекающими клапанами, воздухоотводчиком и дренажным краном. Обратный коллектор с ручными регулирующими клапанами, воздухоотводчиком, дренажным краном и заглушками. В комплекте с кронштейнами

Cod./Code	Mis./Size	Vie/Ways	L (mm)	H (mm)	Att./Conn.	□/田	€
180122502	1"	2	180	200	3/4" EK	1	106,14
180122503	1"	3	230	200	3/4" EK	1	131,51
180122504	1"	4	280	200	3/4" EK	1	157,48
180122505	1"	5	330	200	3/4" EK	1	182,85
180122506	1"	6	380	200	3/4" EK	1	208,51
180122507	1"	7	430	200	3/4" EK	1	234,51
180122508	1"	8	480	200	3/4" EK	1	259,85
180122509	1"	9	530	200	3/4" EK	1	281,38
180122510	1"	10	580	200	3/4" EK	1	307,40
180122511	1"	11	630	200	3/4" EK	1	332,45
180122512	1"	12	680	200	3/4" EK	1	357,38
180132506	1 1/4"	6	380	200	3/4" EK	1	232,38
180132507	1 1/4"	7	430	200	3/4" EK	1	260,35
180132508	1 1/4"	8	480	200	3/4" EK	1	287,75
180132509	1 1/4"	9	530	200	3/4" EK	1	315,18
180132510	1 1/4"	10	580	200	3/4" EK	1	343,59
180132511	1 1/4"	11	630	200	3/4" EK	1	370,92
180132512	1 1/4"	12	680	200	3/4" EK	1	398,35





## IVR 802

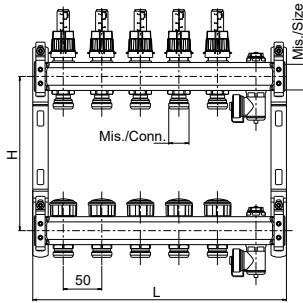

Collettore di mandata con misuratori di portata, valvola di sfogo aria e rubinetto di scarico/carico acqua. Collettore di ritorno con valvole termostattizzabili con cappellotti di regolazione, valvola sfogo aria, rubinetto di carico/scarico e zanche di fissaggio incluse

Inlet manifold with flow meters, air vent and fill/drain valve. Return manifold with thermostatic valves with operating plastic caps, air vent, fill/drain valve, plugs and mounting brackets included

Vorlaufverteiler mit Durchflussmessern, Luftablassventil und Ein-/Ablassventil. Rücklaufverteiler mit thermostatisierbaren Ventilen mit Einstellkappen, Luftablassventil und Ein-/Ablassventil, Stopfen und Befestigungsklammern inklusive

Collecteur de départ avec mesureurs de débit, vanne de purge de l'air et robinet de chargement/déchargement. Collecteur de retour avec vannes thermostatisables avec chapeaux de réglage, vanne de purge de l'air, robinet de déchargement, bouchons et plaques d'ancrage inclus

Подающий коллектор с расходомерами, воздухоотводчиком и дренажным краном. Обратный коллектор с термостатическими клапанами и регулируемыми колпачками, воздухоотводчиком, дренажным краном и заглушками. В комплекте с кронштейнами

Cod./Code	Mis./Size	Vie/Ways	L (mm)	H (mm)	Att./Conn.	□/田	€
180222502	1"	2	180	200	3/4" EK	1	118,57
180222503	1"	3	230	200	3/4" EK	1	150,13
180222504	1"	4	280	200	3/4" EK	1	182,30
180222505	1"	5	330	200	3/4" EK	1	213,88
180222506	1"	6	380	200	3/4" EK	1	245,76
180222507	1"	7	430	200	3/4" EK	1	277,94
180222508	1"	8	480	200	3/4" EK	1	309,49
180222509	1"	9	530	200	3/4" EK	1	337,26
180222510	1"	10	580	200	3/4" EK	1	369,47
180222511	1"	11	630	200	3/4" EK	1	400,72
180222512	1"	12	680	200	3/4" EK	1	431,88
180232506	1"1/4	6	380	200	3/4" EK	1	274,68
180232507	1"1/4	7	430	200	3/4" EK	1	309,67
180232508	1"1/4	8	480	200	3/4" EK	1	344,16
180232509	1"1/4	9	530	200	3/4" EK	1	378,66
180232510	1"1/4	10	580	200	3/4" EK	1	414,08
180232511	1"1/4	11	630	200	3/4" EK	1	448,46
180232512	1"1/4	12	680	200	3/4" EK	1	482,95



## IVR 803

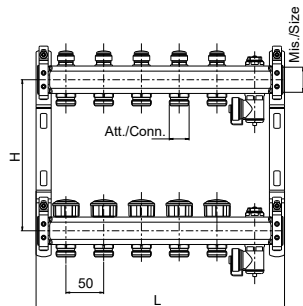

Collettore di mandata con detentori micrometrici, valvola sfogo aria e rubinetto di carico/scarico acqua. Collettore di ritorno con valvole termostattizzabili con cappellotti di regolazione, valvola sfogo aria e zanche di fissaggio incluse

Inlet manifold with micrometric lockshields, air vent and fill/drain valve. Return manifold with thermostatic valves with operating plastic caps, air vent and fill/drain valve, plugs and mounting brackets include.

Vorlaufverteiler mit mikrometrischen Rücklaufverschraubungen, Luftablassventil und Ein-/Ablassventil. Rücklaufverteiler mit thermostatisierbaren Ventilen mit Einstellkappen, Luftablassventil und Ein-/Ablassventil, komplett mit Kappen und Befestigungsklammern

Collecteur d'alimentation avec coude de réglage micrométriques, vanne de purge de l'air et robinet de chargement/déchargement. Collecteur de retour avec vannes thermostatisables avec chapeaux de réglage/déchargement, bouchons et plaques d'ancrage inclus

Подающий коллектор с микрометрическими отсекающими клапанами, воздухоотводчиком и дренажным краном. Обратный коллектор с термостатическими клапанами и регулируемыми колпачками, воздухоотводчиком. В комплекте с кронштейнами

Cod./Code	Mis./Size	Vie/Ways	L (mm)	H (mm)	Att./Conn.	□/田	€
180322502	1"	2	180	200	3/4" EK	1	104,02
180322503	1"	3	230	200	3/4" EK	1	128,62
180322504	1"	4	280	200	3/4" EK	1	153,22
180322505	1"	5	330	200	3/4" EK	1	177,83
180322506	1"	6	380	200	3/4" EK	1	202,75
180322507	1"	7	430	200	3/4" EK	1	227,35
180322508	1"	8	480	200	3/4" EK	1	251,94
180322509	1"	9	530	200	3/4" EK	1	272,73
180322510	1"	10	580	200	3/4" EK	1	297,36
180322511	1"	11	630	200	3/4" EK	1	321,66
180322512	1"	12	680	200	3/4" EK	1	345,85
180332506	1"1/4	6	380	200	3/4" EK	1	226,60
180332507	1"1/4	7	430	200	3/4" EK	1	253,19
180332508	1"1/4	8	480	200	3/4" EK	1	279,86
180332509	1"1/4	9	530	200	3/4" EK	1	306,54
180332510	1"1/4	10	580	200	3/4" EK	1	333,56
180332511	1"1/4	11	630	200	3/4" EK	1	360,13
180332512	1"1/4	12	680	200	3/4" EK	1	386,81



## IVR 804

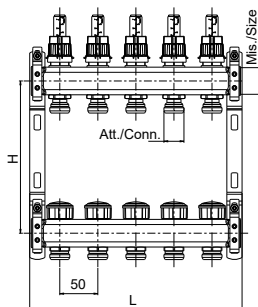

Collettore di mandata con misuratori di portata - collettore di ritorno con valvole termostattizzabili con cappellotti di regolazione, tappi e zanche di fissaggio incluse

Inlet manifold with flow meters - return manifold with thermostatic valves with operating plastic caps, plugs and mounting brackets included.

Vorlaufverteiler mit Durchflussmessern - Rücklaufverteiler mit thermostatisierbaren Ventilen mit Einstellkappen, komplett mit Kappen und Befestigungsklammern

Collecteur d'alimentation avec mesureurs de débit - collecteur de retour avec vannes thermostatisables avec chapeaux de réglage, bouchons et plaques d'ancrage inclus

Входной коллектор с расходомерами - Обратный коллектор с термостатическими клапанами и регулируемыми колпачками. Комплектуется с заглушками для коллектора и кронштейнами.

Cod./Code	Mis./Size	Vie/Ways	L (mm)	H (mm)	Att./Conn.	□/田	€
180422502	1"	2	130	200	3/4" EK	1	92,05
180422503	1"	3	180	200	3/4" EK	1	123,61
180422504	1"	4	230	200	3/4" EK	1	155,78
180422505	1"	5	280	200	3/4" EK	1	187,36
180422506	1"	6	330	200	3/4" EK	1	219,24
180422507	1"	7	380	200	3/4" EK	1	251,42
180422508	1"	8	430	200	3/4" EK	1	282,97
180422509	1"	9	480	200	3/4" EK	1	314,56
180422510	1"	10	530	200	3/4" EK	1	343,34
180422511	1"	11	580	200	3/4" EK	1	374,51
180422512	1"	12	630	200	3/4" EK	1	405,76
180422513	1"	13	680	200	3/4" EK	1	437,53
180432506	1"1/4	6	330	200	3/4" EK	1	246,92
180432507	1"1/4	7	380	200	3/4" EK	1	282,02
180432508	1"1/4	8	430	200	3/4" EK	1	316,39
180432509	1"1/4	9	480	200	3/4" EK	1	350,88
180432510	1"1/4	10	530	200	3/4" EK	1	386,42
180432511	1"1/4	11	580	200	3/4" EK	1	420,81
180432512	1"1/4	12	630	200	3/4" EK	1	455,18
180432513	1"1/4	13	680	200	3/4" EK	1	489,55



## IVR 805

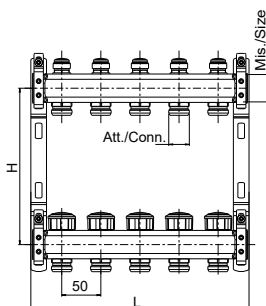

Collettore di mandata con detentori micrometrici - collettore di ritorno con valvole termostattizzabili con cappellotti di regolazione, tappi e zanche di fissaggio incluse

Inlet manifold with micrometric lockshields - return manifold with thermostatic valves with operating plastic caps, plugs included, plugs and mounting brackets included.

Vorlaufverteiler mit mikrometrischen Rücklaufverschraubungen - Rücklaufverteiler mit thermostatisierbaren Ventilen mit Einstellkappen, komplett mit Kappen und Befestigungsklammern

Collecteur d'alimentation avec coude de réglage micrométriques - collecteur de retour avec vannes thermostatisables avec chapeaux de réglage, bouchons et plaques d'ancrage inclus

Входной коллектор с микрометрическими отсекающими вентилями. Обратный коллектор с термостатическими клапанами и регулируемыми колпачками. Комплектуется с заглушками для коллектора и кронштейнами.

Cod./Code	Mis./Size	Vie/Ways	L (mm)	H (mm)	Att./Conn.	□/田	€
180522502	1"	2	130	200	3/4" EK	1	77,50
180522503	1"	3	180	200	3/4" EK	1	102,10
180522504	1"	4	230	200	3/4" EK	1	126,70
180522505	1"	5	280	200	3/4" EK	1	151,31
180522506	1"	6	330	200	3/4" EK	1	175,89
180522507	1"	7	380	200	3/4" EK	1	200,83
180522508	1"	8	430	200	3/4" EK	1	225,42
180522509	1"	9	480	200	3/4" EK	1	250,04
180522510	1"	10	530	200	3/4" EK	1	271,26
180522511	1"	11	580	200	3/4" EK	1	295,46
180522512	1"	12	630	200	3/4" EK	1	319,72
180522513	1"	13	680	200	3/4" EK	1	343,91
180532506	1"1/4	6	330	200	3/4" EK	1	198,86
180532507	1"1/4	7	380	200	3/4" EK	1	225,52
180532508	1"1/4	8	430	200	3/4" EK	1	252,10
180532509	1"1/4	9	480	200	3/4" EK	1	278,77
180532510	1"1/4	10	530	200	3/4" EK	1	305,90
180532511	1"1/4	11	580	200	3/4" EK	1	332,47
180532512	1"1/4	12	630	200	3/4" EK	1	359,05
180532513	1"1/4	13	680	200	3/4" EK	1	385,73



## IVR 806

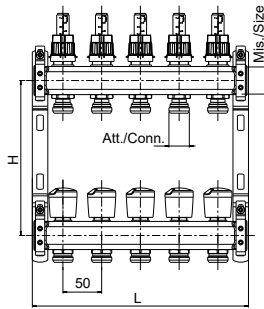

Collettore di mandata con misuratori di portata. Collettore di ritorno con valvole manuali con volantini, tappi e zanche di fissaggio incluse

Inlet manifold with flow meters. Return manifold with manual valves with handles, plugs and mounting brackets included.

Vorlaufverteiler mit Durchflussmessern. Rücklaufverteiler mit Ventilen mit Handrädern, komplett mit Kappen und Befestigungsklammern

Collecteur d'alimentation avec mesureurs de débit. Collecteur de retour avec vannes manuelles avec volants, bouchons et plaques d'ancrage inclus

Входной коллектор с расходомерами. Обратный коллектор с ручными регулирующими клапанами и заглушками. В комплекте с кронштейнами.

Cod./Code	Mis./Size	Vie/Ways	L (mm)	H (mm)	Att./Conn.	□/田	€
180622502	1"	2	130	200	3/4" EK	1	94,18
180622503	1"	3	180	200	3/4" EK	1	126,49
180622504	1"	4	230	200	3/4" EK	1	160,04
180622505	1"	5	280	200	3/4" EK	1	192,36
180622506	1"	6	330	200	3/4" EK	1	225,00
180622507	1"	7	380	200	3/4" EK	1	258,57
180622508	1"	8	430	200	3/4" EK	1	290,88
180622509	1"	9	480	200	3/4" EK	1	323,20
180622510	1"	10	530	200	3/4" EK	1	353,40
180622511	1"	11	580	200	3/4" EK	1	385,30
180622512	1"	12	630	200	3/4" EK	1	417,31
180622513	1"	13	680	200	3/4" EK	1	446,39
180632506	1"1/4	6	330	200	3/4" EK	1	252,69
180632507	1"1/4	7	380	200	3/4" EK	1	288,78
180632508	1"1/4	8	430	200	3/4" EK	1	324,31
180632509	1"1/4	9	480	200	3/4" EK	1	359,54
180632510	1"1/4	10	530	200	3/4" EK	1	396,48
180632511	1"1/4	11	580	200	3/4" EK	1	431,01
180632512	1"1/4	12	630	200	3/4" EK	1	466,73
180632513	1"1/4	13	680	200	3/4" EK	1	499,14



## IVR 807

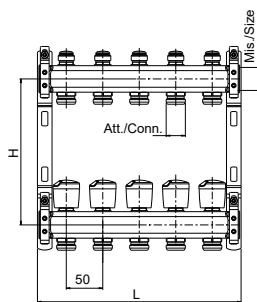

Collettore di mandata con detentori micrometrici. Collettore di ritorno con valvole manuali con volantini, tappi e zanche di fissaggio incluse

Inlet manifold with micrometric lockshields. Return manifold with manual valves with handles, plugs and mounting brackets included.

Vorlaufverteiler mit mikrometrischen Rücklaufverschraubungen. Rücklaufverteiler mit Ventilen mit Handrädern, komplett mit Kappen und Befestigungsklammern

Collecteur d'alimentation avec coude de réglage micrométriques. Collecteur de retour avec vannes manuelles avec volants, bouchons et plaques d'ancrage inclus

Входной коллектор с микрометрическими отсекающими вентилями. Обратный коллектор с ручными регулирующими клапанами и заглушками. В комплекте с кронштейнами.

Cod./Code	Mis./Size	Vie/Ways	L (mm)	H (mm)	Att./Conn.	□/田	€
180722502	1"	2	130	200	3/4" EK	1	79,62
180722503	1"	3	180	200	3/4" EK	1	104,98
180722504	1"	4	230	200	3/4" EK	1	130,96
180722505	1"	5	280	200	3/4" EK	1	156,33
180722506	1"	6	330	200	3/4" EK	1	181,83
180722507	1"	7	380	200	3/4" EK	1	207,98
180722508	1"	8	430	200	3/4" EK	1	233,33
180722509	1"	9	480	200	3/4" EK	1	258,68
180722510	1"	10	530	200	3/4" EK	1	281,31
180722511	1"	11	580	200	3/4" EK	1	306,24
180722512	1"	12	630	200	3/4" EK	1	331,27
180722513	1"	13	680	200	3/4" EK	1	356,86
180732506	1"1/4	6	330	200	3/4" EK	1	204,45
180732507	1"1/4	7	380	200	3/4" EK	1	232,68
180732508	1"1/4	8	430	200	3/4" EK	1	260,35
180732509	1"1/4	9	480	200	3/4" EK	1	287,43
180732510	1"1/4	10	530	200	3/4" EK	1	315,95
180732511	1"1/4	11	580	200	3/4" EK	1	343,27
180732512	1"1/4	12	630	200	3/4" EK	1	370,59
180732513	1"1/4	13	680	200	3/4" EK	1	397,96





## IVR 814

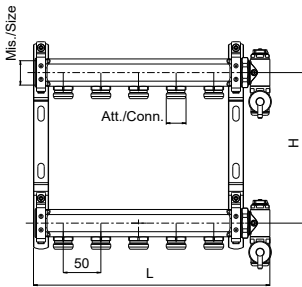

Collettore di mandata con collettore di ritorno con raccordi 3/4" Eurokonus, tappi e zanche di fissaggio incluse  
Inlet and return manifold with 3/4" Eurocone connections, plugs and mounting brackets included.

Vorlaufverteiler mit Rücklaufverteiler mit 3/4" EK Verbindungsstücken, komplett mit Kapfen und Befestigungsklammern

Collecteur d'alimentation avec collecteur de retour avec sorties 3/4" EK, bouchons et plaques d'ancrage inclus

Подающий коллектор с обратным коллектором, соединения 3/4" Евроконус. Комплектуется с заглушками для коллектора и кронштейнами.

Cod./Code	Mis./Size	Vie/Ways	L (mm)	H (mm)	Att./Conn.	□/田	€
181422502	1"	2	130	200	3/4" EK	1	61,18
181422503	1"	3	180	200	3/4" EK	1	77,50
181422504	1"	4	230	200	3/4" EK	1	93,84
181422505	1"	5	280	200	3/4" EK	1	110,14
181422506	1"	6	330	200	3/4" EK	1	126,35
181422507	1"	7	380	200	3/4" EK	1	143,05
181422508	1"	8	430	200	3/4" EK	1	159,37
181422509	1"	9	480	200	3/4" EK	1	175,60
181422510	1"	10	530	200	3/4" EK	1	192,09
181422511	1"	11	580	200	3/4" EK	1	208,42
181422512	1"	12	630	200	3/4" EK	1	224,73
181422513	1"	13	680	200	3/4" EK	1	240,96
181432506	1"1/4	6	330	200	3/4" EK	1	145,67
181432507	1"1/4	7	380	200	3/4" EK	1	163,26
181432508	1"1/4	8	430	200	3/4" EK	1	180,77
181432509	1"1/4	9	480	200	3/4" EK	1	198,16
181432510	1"1/4	10	530	200	3/4" EK	1	215,94
181432511	1"1/4	11	580	200	3/4" EK	1	233,43
181432512	1"1/4	12	630	200	3/4" EK	1	250,95
181432513	1"1/4	13	680	200	3/4" EK	1	268,45



## IVR 875 CS

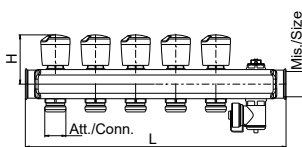

Collettore in acciaio inox AISI 304 1" - 1"1/4 - Connessioni 3/4" EK - Interasse: 50 mm. Collettore di ritorno con valvole manuali con volantini, valvola sfogo aria e rubinetto di carico/scarico acqua

AISI 304 stainless steel manifold 1" - 1"1/4 - 3/4" Eurocone connections - Center hole distance: 50 mm. Return manifold with manual valves with handles, air vent and fill/drain valve.

Verteiler aus rostfreiem Edelstahl AISI 304 1" - 1"1/4 - 3/4" Anschlüsse Eurokonus - Abstand: 50 mm. Rücklaufverteiler mit Ventilen mit Handrädern, Luftablassventil und Ein-/Ablassventil

Collecteur en acier inox AISI 304 1" - 1"1/4 - connexion 3/4" eurocone - entraxes: 50mm. Collecteur de retour avec vannes manuelles avec volants, vanne de purge de l'air et robinet de chargement/déchargement

Коллектор из нержавеющей стали AISI 304, размеры 1" - 1"1/4 - 3/4" соединение Евроконус, межосевое расстояние 50 мм. Обратный коллектор с ручными регулирующими клапанами, воздухоотводчиком и дренажным клапаном

Cod./Code	Mis./Size	Vie/Ways	L (mm)	H (mm)	Att./Conn.	□/田	€
187510502	1"	2	175	61	3/4" EK	1/6	47,24
187510503	1"	3	225	61	3/4" EK	1/4	61,47
187510504	1"	4	275	61	3/4" EK	1/4	76,14
187510505	1"	5	325	61	3/4" EK	1/4	90,37
187510506	1"	6	375	61	3/4" EK	1/6	104,44
187510507	1"	7	425	61	3/4" EK	1/6	119,30
187510508	1"	8	475	61	3/4" EK	1/6	133,39
187510509	1"	9	525	61	3/4" EK	1/6	145,78
187510510	1"	10	575	61	3/4" EK	1/6	160,31
187510511	1"	11	625	61	3/4" EK	1/6	174,25
187510512	1"	12	675	61	3/4" EK	1/6	188,14
187512506	1"1/4	6	375	66	3/4" EK	1	110,57
187512507	1"1/4	7	425	66	3/4" EK	1	125,76
187512508	1"1/4	8	475	66	3/4" EK	1	140,90
187512509	1"1/4	9	525	66	3/4" EK	1	156,12
187512510	1"1/4	10	575	66	3/4" EK	1	171,30
187512511	1"1/4	11	625	66	3/4" EK	1	186,50
187512512	1"1/4	12	675	66	3/4" EK	1	201,67



## IVR 875

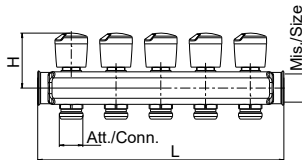

Collettore in acciaio inox AISI 304 1" - 1"1/4 - Connessioni 3/4" EK - Interasse: 50 mm. Collettore di ritorno con valvole manuali con volantini.

AISI 304 stainless steel manifold 1" - 1"1/4 - 3/4" Eurocone connections - Center hole distance 50 mm. Return manifold with manual valves with handles.

Verteiler aus rostfreiem Edelstahl AISI 304 1" - 1"1/4 - 3/4" Anschlüsse Eurokonus - Abstand 50 mm. Rücklaufverteiler mit Ventilen mit Handrädern.

Collecteur en acier inox AISI 304 1" - 1"1/4 - connexion 3/4" eurocone - entraxes 50mm. Collecteur de retour avec vannes manuelles avec volants.

Коллектор из нержавеющей стали AISI 304, размеры 1" - 1"1/4 - 3/4", соединение Евроконус, межосевое расстояние 50 мм. Обратный коллектор с ручными регулируемыми клапанами.

Cod./Code	Mis./Size	Vie/Ways	L (mm)	H (mm)	Att./Conn.	□/田	€
187511502	1"	2	125	61	3/4" EK	1/24	34,05
187511503	1"	3	175	61	3/4" EK	1/12	48,48
187511504	1"	4	225	61	3/4" EK	1/12	63,15
187511505	1"	5	275	61	3/4" EK	1/4	77,15
187511506	1"	6	325	61	3/4" EK	1/2	91,16
187511507	1"	7	375	61	3/4" EK	1/2	105,99
187511508	1"	8	425	61	3/4" EK	1/2	120,12
187511509	1"	9	475	61	3/4" EK	1/2	134,32
187511510	1"	10	525	61	3/4" EK	1/2	147,15
187511511	1"	11	575	61	3/4" EK	1/2	161,04
187511512	1"	12	625	61	3/4" EK	1/2	174,99
187511513	1"	13	675	61	3/4" EK	1/2	188,81
187513506	1"1/4	6	325	66	3/4" EK	1	97,51
187513507	1"1/4	7	375	66	3/4" EK	1	112,74
187513508	1"1/4	8	425	66	3/4" EK	1	127,91
187513509	1"1/4	9	475	66	3/4" EK	1	144,57
187513510	1"1/4	10	525	66	3/4" EK	1	158,29
187513511	1"1/4	11	575	66	3/4" EK	1	173,47
187513512	1"1/4	12	625	66	3/4" EK	1	188,65
187513513	1"1/4	13	675	66	3/4" EK	1	203,83



## IVR 877 CS

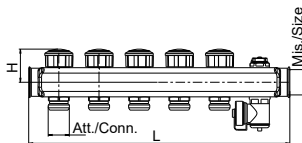

Collettore in acciaio inox AISI 304 1" - 1"1/4 - Connessioni 3/4" EK - Interasse: 50 mm. Collettore di ritorno con valvole termostattabili e cappellotti di regolazione, valvola sfogo aria e rubinetto di carico/scarico acqua

AISI 304 stainless steel manifold 1" - 1"1/4 - 3/4" Eurocone connections - Center hole distance 50 mm. Return manifold with thermostatic valves and operating plastic caps, air vent and fill/drain valve.

Verteiler aus rostfreiem Edelstahl AISI 304 1" - 1"1/4 - 3/4" Anschlüsse Eurokonus - Abstand 50 mm. Rücklaufverteiler mit thermostatisierbaren Ventilen und Handrädern, Luftablassventil und Ein-/Ablassventil

Collecteur en acier inox AISI 304 1" - 1"1/4 - connexion 3/4" eurocone - entraxes 50mm. Collecteur de retour avec vannes thermostatisables et chapeaux de réglage, vanne de purge d'air et robinet de chargement/déchargement

Коллектор из нержавеющей стали AISI 304, размеры 1" - 1"1/4 - 3/4" соединение Евроконус, межосевое расстояние 50 мм. Обратный коллектор с термостатическими клапанами, воздухоотводчиком и дренажным клапаном

Cod./Code	Mis./Size	Vie/Ways	L (mm)	H (mm)	Att./Conn.	□/田	€
187710502	1"	2	175	44	3/4" EK	1/16	45,20
187710503	1"	3	225	44	3/4" EK	1/16	58,55
187710504	1"	4	275	44	3/4" EK	1/5	71,87
187710505	1"	5	325	44	3/4" EK	1/5	85,26
187710506	1"	6	375	44	3/4" EK	1/5	98,48
187710507	1"	7	425	44	3/4" EK	1/5	112,01
187710508	1"	8	475	44	3/4" EK	1/5	125,35
187710509	1"	9	525	44	3/4" EK	1/5	136,94
187710510	1"	10	575	44	3/4" EK	1/5	150,07
187710511	1"	11	625	44	3/4" EK	1/5	163,27
187710512	1"	12	675	44	3/4" EK	1/5	176,41
187712506	1"1/4	6	375	49	3/4" EK	1/10	107,13
187712507	1"1/4	7	425	49	3/4" EK	1/10	121,59
187712508	1"1/4	8	475	49	3/4" EK	1/10	135,20
187712509	1"1/4	9	525	49	3/4" EK	1/7	149,73
187712510	1"1/4	10	575	49	3/4" EK	1/7	164,20
187712511	1"1/4	11	625	49	3/4" EK	1/7	178,67
187712512	1"1/4	12	675	49	3/4" EK	1/7	193,15



## IVR 877

Collettore in acciaio inox AISI 304 1" - 1"1/4 - Connessioni 3/4" EK - Interasse: 50 mm. Collettore di ritorno con valvole termostattizzabili con cappellotti di regolazione

AISI 304 stainless steel manifold 1" - 1"1/4 - 3/4" Eurocone connections - Center hole distance 50 mm. Return manifold with thermostatic valves and operating plastic caps.

Verteiler aus rostfreiem Edelstahl AISI 304 1" - 1"1/4 - 3/4" Anschlüsse Eurokonus - Abstand 50 mm. Rücklaufverteiler mit thermostatisierbaren Ventilen mit Handrädern.

Collecteur en acier inox AISI 304 1" - 1"1/4 - connexion 3/4" eurocone - entraxes 50mm. Collecteur de retour avec vannes thermostatizables et chapeaux de réglage

Коллектор из нержавеющей стали AISI 304, размеры 1" - 1"1/4 - 3/4" соединение Евроконус, межосевое расстояние 50 мм. Обратный коллектор с термостатическими клапанами и регулируемыми колпачками.

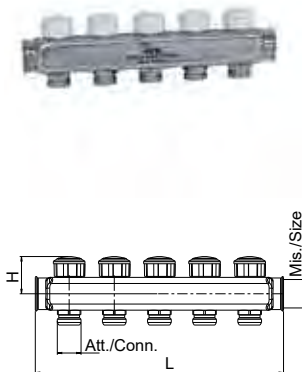

Cod./Code	Mis./Size	Vie/Ways	L (mm)	H (mm)	Att./Conn.	□/田	€
187711502	1"	2	125	44	3/4" EK	1/40	32,06
187711503	1"	3	175	44	3/4" EK	1/16	45,59
187711504	1"	4	225	44	3/4" EK	1/8	58,86
187711505	1"	5	275	44	3/4" EK	1/5	72,18
187711506	1"	6	325	44	3/4" EK	1/5	85,79
187711507	1"	7	375	44	3/4" EK	1/5	98,93
187711508	1"	8	425	44	3/4" EK	1/5	112,55
187711509	1"	9	475	44	3/4" EK	1/5	125,90
187711510	1"	10	525	44	3/4" EK	1/5	137,42
187711511	1"	11	575	44	3/4" EK	1/5	150,55
187711512	1"	12	625	44	3/4" EK	1/5	163,74
187711513	1"	13	625	44	3/4" EK	1/5	176,87
187713506	1"1/4	6	325	49	3/4" EK	1	93,24
187713507	1"1/4	7	375	49	3/4" EK	1	107,76
187713508	1"1/4	8	425	49	3/4" EK	1	122,23
187713509	1"1/4	9	475	49	3/4" EK	1	136,65
187713510	1"1/4	10	525	49	3/4" EK	1	151,17
187713511	1"1/4	11	575	49	3/4" EK	1	165,64
187713512	1"1/4	12	625	49	3/4" EK	1	180,11
187713513	1"1/4	13	675	49	3/4" EK	1	194,58



## IVR 878 CS

Collettore in acciaio inox AISI 304 1" - 1"1/4 - Connessioni 3/4" EK - Interasse: 50 mm. Collettore di mandata con misuratori di portata 0,5-5 lt/min. valvola sfogo aria, rubinetto di carico/scarico

AISI 304 stainless steel manifold 1" - 1"1/4 - 3/4" Eurocone connections - Center hole distance 50 mm. Inlet manifold with flow meters 0,5-5 L/min, air vent and fill/drain valve.

Verteiler aus rostfreiem Edelstahl AISI 304 1" - 1"1/4 - 3/4" Anschlüsse Eurokonus - Abstand 50 mm. Vorlaufverteiler mit Durchflussmessern 0,5-5 lt/min. Luftablassventil und Ein-/Ablassventil

Collecteur en acier inox AISI 304 1" - 1"1/4 - connexion 3/4" eurocone - entraxes 50mm. Collecteur d'alimentation avec débitmètres 0,5-5 lt/min., vanne de purge de l'air et robinet de chargement/déchargement

Коллектор из нержавеющей стали AISI 304, размеры 1" - 1"1/4 - 3/4" соединение Евроконус, межосевое расстояние 50 мм. Входной коллектор с расходомерами 0,5-5 л/мин, воздухоотводчиком и дренажным клапаном

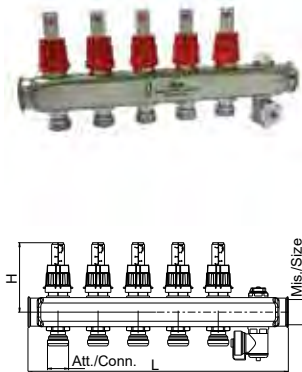

Cod./Code	Mis./Size	Vie/Ways	L (mm)	H (mm)	Att./Conn.	□/田	€
187810502	1"	2	175	78	3/4" EK	1/6	55,43
187810503	1"	3	225	78	3/4" EK	1/4	73,75
187810504	1"	4	275	78	3/4" EK	1/4	92,57
187810505	1"	5	325	78	3/4" EK	1/6	111,34
187810506	1"	6	375	78	3/4" EK	1/8	129,09
187810507	1"	7	425	78	3/4" EK	1/8	147,92
187810508	1"	8	475	78	3/4" EK	1/6	166,24
187810509	1"	9	525	78	3/4" EK	1/6	182,75
187810510	1"	10	575	78	3/4" EK	1/6	201,37
187810511	1"	11	625	78	3/4" EK	1/6	219,43
187810512	1"	12	675	78	3/4" EK	1/6	237,45
187812506	1"1/4	6	375	83	3/4" EK	1	142,01
187812507	1"1/4	7	425	83	3/4" EK	1	162,63
187812508	1"1/4	8	475	83	3/4" EK	1	182,88
187812509	1"1/4	9	525	83	3/4" EK	1	203,25
187812510	1"1/4	10	575	83	3/4" EK	1	223,88
187812511	1"1/4	11	625	83	3/4" EK	1	244,18
187812512	1"1/4	12	675	83	3/4" EK	1/7	264,52



## IVR 878

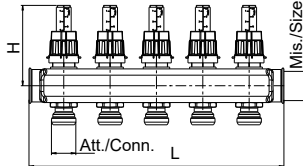

Collettore in acciaio inox AISI 304 1" - 1"1/4 - Connessioni 3/4" EK - Interasse: 50 mm. Collettore di mandata con misuratori di portata 0,5-5 lt/min.

AISI 304 stainless steel manifold 1" - 1"1/4 - 3/4" Eurocone connections - Center hole distance: 50 mm. Inlet manifold with flow meters 0,5-5 L/min

Verteiler aus rostfreiem Edelstahl AISI 304 1" - 1"1/4 - 3/4" Anschlüsse Eurokonus - Abstand 50: mm. Vorlaufverteiler mit Durchflussmessern 0,5-5 lt/min

Collecteur en acier inox AISI 304 1" - 1"1/4 - connexion 3/4" eurocone - entraxes 50mm. Collecteur d'alimentation avec débitmètres 0,5-5 lt/min

Коллектор из нержавеющей стали AISI 304, размеры 1" - 1"1/4 - 3/4" соединение Евроконус, межосевое расстояние 50 мм. Входной коллектор с расходомерами 0,5-5 л/мин.

Cod./Code	Mis./Size	Vie/Ways	L (mm)	H (mm)	Att./Conn.	□/田	€
187811501	1"	2	125	93	3/4" EK	1/15	27,90
187811502	1"	2	125	93	3/4" EK	1/8	42,11
187811503	1"	3	175	93	3/4" EK	1/6	60,42
187811504	1"	4	225	93	3/4" EK	1/4	79,32
187811505	1"	5	275	93	3/4" EK	1/4	97,53
187811506	1"	6	325	93	3/4" EK	1/2	116,30
187811507	1"	7	375	93	3/4" EK	1/2	134,65
187811508	1"	8	425	93	3/4" EK	1/2	152,88
187811509	1"	9	475	93	3/4" EK	1/2	171,20
187811510	1"	10	525	93	3/4" EK	1/2	188,32
187811511	1"	11	575	93	3/4" EK	1/2	206,33
187811512	1"	12	625	93	3/4" EK	1/2	224,39
187811513	1"	13	675	93	3/4" EK	1/2	226,07
187813506	1"1/4	6	325	95	3/4" EK	1	128,91
187813507	1"1/4	7	375	95	3/4" EK	1	149,59
187813508	1"1/4	8	425	95	3/4" EK	1	169,90
187813509	1"1/4	9	475	95	3/4" EK	1	190,18
187813510	1"1/4	10	525	95	3/4" EK	1	210,84
187813511	1"1/4	11	575	95	3/4" EK	1	231,18
187813512	1"1/4	12	625	95	3/4" EK	1	251,48
187813513	1"1/4	13	675	95	3/4" EK	1	272,11



## IVR 879 CS

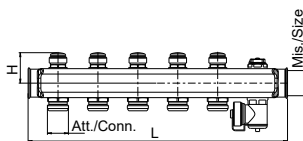

Collettore in acciaio inox AISI 304 1" - 1"1/4 - Connessioni 3/4" EK - Interasse: 50 mm. Collettore di mandata con detentori micrometrici, valvola sfogo aria, rubinetto di carico/scarico acqua

AISI 304 stainless steel manifold 1" - 1"1/4 - 3/4" Eurocone connections - Center hole distance 50 mm. Inlet manifold with micrometric lockshields, air vent, fill/drain valve.

Verteiler aus rostfreiem Edelstahl AISI 304 1" - 1"1/4 - 3/4" Anschlüsse Eurokonus - Abstand 50 mm. Vorlaufverteiler mit mikrometrischen Rücklaufverschraubungen und Ein-/Ablassventil

Collecteur en acier inox AISI 304 1" - 1"1/4 - connexion 3/4" eurocone - entraxes 50mm. Collecteur d'alimentation avec coudes de réglage micrométriques, vanne de purge de l'air, robinet de chargement/déchargement

Коллектор из нержавеющей стали AISI 304, размеры 1" - 1"1/4 - 3/4" соединение Евроконус, межосевое расстояние 50 мм. Входной коллектор с микрометрическими отсекающими клапанами, воздухоотводчиком и дренажным клапаном

Cod./Code	Mis./Size	Vie/Ways	L (mm)	H (mm)	Att./Conn.	□/田	€
187910502	1"	2	175	38	3/4" EK	1/16	41,18
187910503	1"	3	225	38	3/4" EK	1/16	52,42
187910504	1"	4	275	38	3/4" EK	1/4	63,66
187910505	1"	5	325	38	3/4" EK	1/5	74,95
187910506	1"	6	375	38	3/4" EK	1/9	86,10
187910507	1"	7	425	38	3/4" EK	1/8	97,52
187910508	1"	8	475	38	3/4" EK	1/8	108,77
187910509	1"	9	525	38	3/4" EK	1/8	118,27
187910510	1"	10	575	38	3/4" EK	1/8	129,32
187910511	1"	11	625	38	3/4" EK	1/8	140,40
187910512	1"	12	675	38	3/4" EK	1/8	151,44
187912506	1"1/4	6	375	42	3/4" EK	1/10	94,29
187912507	1"1/4	7	425	42	3/4" EK	1/10	106,54
187912508	1"1/4	8	475	42	3/4" EK	1/8	118,09
187912509	1"1/4	9	525	42	3/4" EK	1/8	130,37
187912510	1"1/4	10	575	42	3/4" EK	1/7	142,62
187912511	1"1/4	11	625	42	3/4" EK	1/7	154,87
187912512	1"1/4	12	675	42	3/4" EK	1/7	167,15





## IVR 879

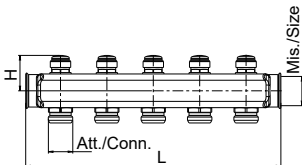

Collettore in acciaio inox AISI 304 1" - 1"1/4 - Connessioni 3/4" EK - Interasse: 50 mm. Collettore di mandata con detentori micrometrici

AISI 304 stainless steel manifold 1" - 1"1/4 - 3/4" Eurocone connections - Center hole distance: 50 mm. Inlet manifold with micrometric lockshields

Verteiler aus rostfreiem Edelstahl AISI 304 1" - 1"1/4 - 3/4" Anschlüsse Eurokonus - Abstand: 50 mm. Rücklaufvorlaufverteiler mit mikrometrischen Rücklaufverschraubungen

Collecteur en acier inox AISI 304 1" - 1"1/4 - connexion 3/4" eurocone - entraxes: 50mm. Collecteur d'alimentation avec coudes de réglage micrométriques

Коллектор из нержавеющей стали AISI 304, размеры 1" - 1"1/4 - 3/4" соединения Евроконус, межосевое расстояние 50 мм. Входной коллектор с микрометрическими отсекающими клапанами.

Cod./Code	Mis./Size	Vie/Ways	L (mm)	H (mm)	Att./Conn.	□/⊞	€
187911502	1"	2	125	38	3/4" EK	1/40	27,62
187911503	1"	3	175	38	3/4" EK	1/16	39,08
187911504	1"	4	225	38	3/4" EK	1/8	50,13
187911505	1"	5	275	38	3/4" EK	1/8	61,36
187911506	1"	6	325	38	3/4" EK	1/5	72,66
187911507	1"	7	375	38	3/4" EK	1/5	83,94
187911508	1"	8	425	38	3/4" EK	1/5	95,33
187911509	1"	9	475	38	3/4" EK	1/5	106,59
187911510	1"	10	525	38	3/4" EK	1/5	116,09
187911511	1"	11	575	38	3/4" EK	1/5	127,12
187911512	1"	12	625	38	3/4" EK	1/5	138,22
187911513	1"	13	675	38	3/4" EK	1/5	149,28
187913506	1"1/4	6	325	42	3/4" EK	1	79,94
187913507	1"1/4	7	375	42	3/4" EK	1	92,24
187913508	1"1/4	8	425	42	3/4" EK	1	104,50
187913509	1"1/4	9	475	42	3/4" EK	1	116,71
187913510	1"1/4	10	525	42	3/4" EK	1	129,00
187913511	1"1/4	11	575	42	3/4" EK	1	141,25
187913512	1"1/4	12	625	42	3/4" EK	1	153,52
187913513	1"1/4	13	675	42	3/4" EK	1	165,78



## IVR 871

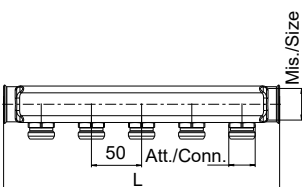

Collettore in acciaio inox AISI 304 1" - 1"1/4, interasse 50 mm 3/4" EK

AISI 304 stainless steel manifold 1" - 1" 1/4, center hole distance 50 mm 3/4" EK

Verteiler aus rostfreiem Edelstahl AISI 304 1" - 1" 1/4 Anschlüsse, Abstand 50 mm 3/4" EK

Collecteur en acier inox AISI 304 1" - 1" 1/4, entraxes 50mm 3/4" EK

Коллектор из нержавеющей стали AISI 304, размеры 1" - 1" 1/4, межосевое расстояние 50 мм 3/4" EK

Cod./Code	Mis./Size	Vie/Ways	L (mm)	Att./Conn.	□/⊞	€
187111502	1"	2	125	3/4" EK	1/12	21,49
187111503	1"	3	175	3/4" EK	1/10	29,79
187111504	1"	4	225	3/4" EK	1/8	38,01
187111505	1"	5	275	3/4" EK	1/5	46,10
187111506	1"	6	325	3/4" EK	1/5	52,32
187111507	1"	7	375	3/4" EK	1/5	60,10
187111508	1"	8	425	3/4" EK	1/5	70,70
187111509	1"	9	475	3/4" EK	1/5	75,89
187111510	1"	10	525	3/4" EK	1/5	83,82
187111511	1"	11	575	3/4" EK	1/5	91,66
187111512	1"	12	625	3/4" EK	1/5	99,54
187111513	1"	13	675	3/4" EK	1/5	107,06
187113506	1"1/4	6	325	3/4" EK	1/5	57,68
187113507	1"1/4	7	375	3/4" EK	1/5	66,32
187113508	1"1/4	8	425	3/4" EK	1/5	74,90
187113509	1"1/4	9	475	3/4" EK	1/5	83,49
187113510	1"1/4	10	525	3/4" EK	1/5	92,08
187113511	1"1/4	11	575	3/4" EK	1/5	100,67
187113512	1"1/4	12	625	3/4" EK	1/5	109,26
187113513	1"1/4	13	675	3/4" EK	1/5	117,84



## IVR 868

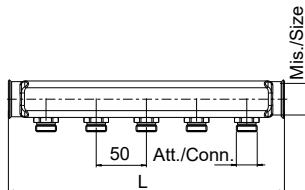

Collettore in acciaio inox AISI 304 1" - 1" 1/4, interasse 50 mm 1/2"

AISI 304 stainless steel manifold 1" - 1" 1/4, center hole distance 50 mm 1/2"

Verteiler aus rostfreiem Edelstahl AISI 304 1" - 1" 1/4 Anschlüsse, Abstand 50 mm 1/2"

Collecteur en acier inox AISI 304 1" - 1" 1/4, entraxes 50mm 1/2"

Коллектор из нержавеющей стали AISI 304, размеры 1" - 1" 1/4, межосевое расстояние 50 мм 1/2"

Cod./Code	Mis./Size	Vie/Ways	L (mm)	Att./Conn.	□/田	€
186811502	1"	2	125	1/2"	1/60	18,83
186811503	1"	3	175	1/2"	1/24	25,56
186811504	1"	4	225	1/2"	1/24	32,08
186811505	1"	5	275	1/2"	1/10	38,65
186811506	1"	6	325	1/2"	1/8	42,85
186811507	1"	7	375	1/2"	1/12	49,19
186811508	1"	8	425	1/2"	1/12	58,25
186811509	1"	9	475	1/2"	1/12	61,52
186811510	1"	10	525	1/2"	1/16	67,78
186811511	1"	11	575	1/2"	1/16	73,99
186811512	1"	12	625	1/2"	1/16	80,26
186811513	1"	13	675	1/2"	1/16	86,47
186813506	1"1/4	6	325	1/2"	1/5	49,02
186813507	1"1/4	7	375	1/2"	1/5	56,09
186813508	1"1/4	8	425	1/2"	1/5	63,14
186813509	1"1/4	9	475	1/2"	1/5	70,18
186813510	1"1/4	10	525	1/2"	1/5	77,22
186813511	1"1/4	11	575	1/2"	1/5	84,27
186813512	1"1/4	12	625	1/2"	1/5	91,30
186813513	1"1/4	13	675	1/2"	1/5	98,68



## IVR 869

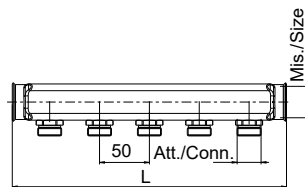

Collettore in acciaio inox AISI 304 1" - 1" 1/4, interasse 50 mm 24-19

AISI 304 stainless steel manifold 1" - 1" 1/4, center hole distance 50 mm 24-19

Verteiler aus rostfreiem Edelstahl AISI 304 1" - 1" 1/4 Anschlüsse, Abstand 50 mm 24-19

Collecteur en acier inox AISI 304 1" - 1" 1/4, entraxes 50mm 24-19

Коллектор из нержавеющей стали AISI 304, размеры 1" - 1" 1/4, межосевое расстояние 50 мм 24-19

Cod./Code	Mis./Size	Vie/Ways	L (mm)	Att./Conn.	□/田	€
186911502	1"	2	125	24-19	1/60	18,05
186911503	1"	3	175	24-19	1/24	24,57
186911504	1"	4	225	24-19	1/24	31,01
186911505	1"	5	275	24-19	1/10	37,43
186911506	1"	6	325	24-19	1/8	41,71
186911507	1"	7	375	24-19	1/12	47,83
186911508	1"	8	425	24-19	1/12	56,67
186911509	1"	9	475	24-19	1/12	60,09
186911510	1"	10	525	24-19	1/16	66,24
186911511	1"	11	575	24-19	1/16	72,37
186911512	1"	12	625	24-19	1/16	78,51
186911513	1"	13	675	24-19	1/16	84,63
186913506	1"1/4	6	325	24-19	1/5	47,33
186913507	1"1/4	7	375	24-19	1/5	54,24
186913508	1"1/4	8	425	24-19	1/5	61,11
186913509	1"1/4	9	475	24-19	1/5	67,96
186913510	1"1/4	10	525	24-19	1/5	74,83
186913511	1"1/4	11	575	24-19	1/5	81,68
186913512	1"1/4	12	625	24-19	1/5	88,55
186913513	1"1/4	13	675	24-19	1/5	95,41



## IVR 867

Collettore in acciaio inox AISI 304 1" - 1"1/4, interasse 50 mm 1/2" F

AISI 304 stainless steel manifold 1" - 1" 1/4, center hole distance 50 mm 1/2" F

Verteiler aus rostfreiem Edelstahl AISI 304 1" - 1" 1/4 Anschlüsse, Abstand 50 mm 1/2" IG

Collecteur en acier inox AISI 304 1" - 1" 1/4, entraxes 50 mm 1/2" F

Коллектор из нержавеющей стали AISI 304, размеры 1" - 1" 1/4, межосевое расстояние 50 мм 1/2" B

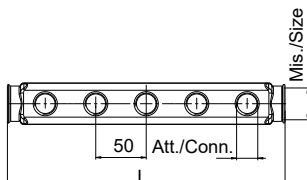

Cod./Code	Mis./Size	Vie/Ways	L (mm)	Att./Conn.	□/⊞	€
<b>186711502</b>	1"	2	125	1/2" F	1/28	9,88
<b>186711503</b>	1"	3	175	1/2" F	1/24	13,42
<b>186711504</b>	1"	4	225	1/2" F	1/18	16,96
<b>186711505</b>	1"	5	275	1/2" F	1/12	20,56
<b>186711506</b>	1"	6	325	1/2" F	1/12	22,02
<b>186711507</b>	1"	7	375	1/2" F	1/12	25,29
<b>186711508</b>	1"	8	425	1/2" F	1/12	31,18
<b>186711509</b>	1"	9	475	1/2" F	1/12	31,69
<b>186711510</b>	1"	10	525	1/2" F	1/12	34,89
<b>186711511</b>	1"	11	575	1/2" F	1/12	38,05
<b>186711512</b>	1"	12	625	1/2" F	1/12	41,27
<b>186711513</b>	1"	13	675	1/2" F	1/12	44,44
<b>186713506</b>	1"1/4	6	325	1/2" F	1/4	27,73
<b>186713507</b>	1"1/4	7	375	1/2" F	1/4	31,71
<b>186713508</b>	1"1/4	8	425	1/2" F	1/4	35,61
<b>186713509</b>	1"1/4	9	475	1/2" F	1/4	39,55
<b>186713510</b>	1"1/4	10	525	1/2" F	1/4	43,49
<b>186713511</b>	1"1/4	11	575	1/2" F	1/4	47,42
<b>186713512</b>	1"1/4	12	625	1/2" F	1/4	51,34
<b>186713513</b>	1"1/4	13	675	1/2" F	1/4	55,27



## COLLETTORI IN OTTONE BRASS MANIFOLDS

### IVR 872



Collettore componibile stampato in ottone interasse 38 mm M/F 3/4" - 1" - nichelato. Collettori con attacchi M 1/2"  
Modular manifold in forged brass, centre hole distance 38 mm M/F 3/4" - 1" - nickel-plated. M 1/2" connections  
Modularer Verteiler aus Pressmessing, Stützen-Abstand 38 mm, AG/IG 3/4" - 1" - vernickelt. Anschlüsse AG 1/2"  
Collecteur pré-assemblé en laiton Entraxe 38 mm M/F 3/4" - 1" - nickelé. Fixation M 1/2"  
Модульный никелированный коллектор из штампованной латуни. Соединение Н/В 3/4" - 1", межосевое расстояние 38 мм. Коллекторы с соединениями Н 1/2"

Cod./Code	Mis./Size	Vie/Ways	L (mm)	Att./Conn.	□/⊕	€
187211302	3/4"	2	90	1/2"	1/60	9,18
187211303	3/4"	3	128	1/2"	1/40	13,13
187211304	3/4"	4	166	1/2"	1/40	17,03
187221302	1"	2	96	1/2"	1/60	10,69
187221303	1"	3	131	1/2"	1/40	14,86
187221304	1"	4	169	1/2"	1/40	19,97



### IVR 873

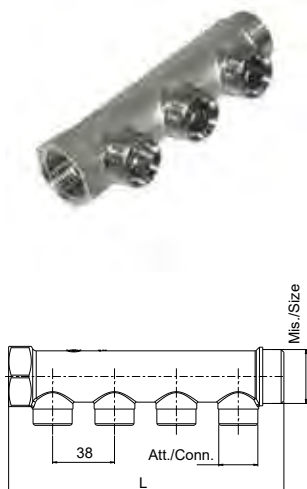

Collettore componibile stampato in ottone interasse 38 mm M/F 3/4" - 1" - nichelato. Collettori con attacchi M 24-19  
Modular manifold in forged brass, centre hole distance 38 mm M/F 3/4" - 1" - nickel-plated. M 24-19 connections.  
Modularer Verteiler aus Pressmessing, Stützen-Abstand 38 mm, AG/IG 3/4" - 1" - vernickelt. Anschlüsse AG M 24-19  
Collecteur pré-assemblé en laiton Entraxe 38 mm M/F 3/4" - 1" - nickelé. Fixation M 24-19  
Модульный никелированный коллектор из штампованной латуни. Соединение Н/В 3/4" - 1", межосевое расстояние 38 мм. Коллекторы с соединениями Н 24-19

Cod./Code	Mis./Size	Vie/Ways	L (mm)	Att./Conn.	□/⊕	€
187311302	3/4"	2	90	24-19	1/60	9,54
187311303	3/4"	3	128	24-19	1/40	13,18
187311304	3/4"	4	166	24-19	1/40	17,06
187321302	1"	2	96	24-19	1/60	10,79
187321303	1"	3	131	24-19	1/40	14,86
187321304	1"	4	169	24-19	1/40	19,97





## IVR 858

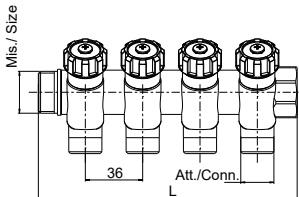

Collettori componibili stampati in ottone con rubinetti d'intercettazione - interasse 36 mm - M/F 3/4"-1", derivazioni M 1/2"- 24/19 - nichelato

Brass modular sanitary manifolds with shut off valve - centre hole distance 36 mm - M/F 3/4"-1", with M 1/2"- 24/19" connection - nickel-plated

Modulare Verteiler aus Pressmessing mit Absperrventilen - Stützen-Abstand 36 mm - AG/IG 3/4"-1", Ableitung AG 1/2"- 24/19 - vernickelt

Collecteurs modulables estampés en laiton avec robinets de sectionnement - entraxe 36 mm - M/F 3/4"-1", fixation M 1/2" - 24/19 - nickelé

Модульные коллекторы из штампованной никелированной латуни, с отсекающими клапанами - межосевое расстояние 36мм - Н/В 3/4"-1", отводы Н 1/2"- 24/19 – никелированные

Cod./Code	Mis./Size	Vie/Ways	L (mm)	Att./Conn.	□/田	€
185811202S	3/4"	2	88	1/2"	1/60	16,81
185811203S	3/4"	3	124	1/2"	1/35	24,13
185811204S	3/4"	4	160	1/2"	1/30	31,20
185811205S	3/4"	5	216	1/2"	1/30	42,95
185813202S	3/4"	2	88	24-19	1/60	17,33
185813203S	3/4"	3	124	24-19	1/35	24,66
185813204S	3/4"	4	160	24-19	1/30	31,98
185813205S	3/4"	5	196	24-19	1/30	45,07
185821202S	1"	2	93	1/2"	1/50	23,25
185821203S	1"	3	129	1/2"	1/30	33,18
185821204S	1"	4	165	1/2"	1/30	43,63
185823202S	1"	2	93	24-19	1/50	23,93
185823203S	1"	3	129	24-19	1/30	33,77
185823204S	1"	4	165	24-19	1/30	44,37



## VALVOLE SFOGO ARIA AIR-VENT VALVES

### IVR 360



Valvola automatica di sfogo aria Ø 42 sfogo aria superiore, nichelata  
Automatic air-vent nickel-plated - Ø 42 top air-vent  
Automatisches Entlüftungsventil vernickelt - Ø 42 - Entlüftung oben -  
Vanne automatique purgeur d'air nickelée - Ø 42 vanne automatique de purge supérieure  
Автоматический воздухоотводчик, никелированный - Ø 42 - воздухоотвод вертикальный

Cod./Code	Mis./Size	□/田	€
136003001	3/8"	16/64	9,11
136005001	1/2"	16/64	9,11
136007001	3/4"	16/64	9,11
136010001	1"	10/100	12,82



### IVR 361



Valvola automatica di sfogo aria Ø 39 attacco laterale, nichelata  
Automatic air-vent nickel-plated - Ø 39 side connection  
Automatisches Entlüftungsventil vernickelt - Ø 39 - mit seitlichem Außenanschlussgewinde  
Vanne automatique purgeur d'air nickelée - Ø 39 fixation lateral  
Автоматический воздухоотводчик, никелированный - Ø 39 с боковым подключением

Cod./Code	Mis./Size	□/田	€
136103001	3/8"	10/60	10,33
136105001	1/2"	10/60	10,33



### IVR 816



Valvola automatica di sfogo aria, sfogo aria laterale, nichelata  
Automatic air-vent, side release, nickel-plated  
Automatisches Entlüftungsventil vernickelt - Entlüftung seitlich  
Vanne automatique purgeur d'air nickelée - purgeur d'air lateral  
Автоматический воздухоотводчик никелированный - воздухоотвод боковой

Cod./Code	Mis./Size	□/田	€
181603001	3/8"	16/64	9,29



### IVR 832



Valvola automatica di sfogo aria Ø 50 sfogo aria superiore, nichelata  
Automatic air-vent, Ø 50 top release, nickel-plated  
Automatisches Entlüftungsventil vernickelt - Ø 50 - Entlüftung oben  
Vanne automatique purgeur d'air nickelée - Purge d'air Ø 50 superieur  
Автоматический воздухоотводчик никелированный - Ø 50 - воздухоотвод вертикальный

Cod./Code	Mis./Size	□/田	€
183203001	3/8"	10/60	9,76
183205001	1/2"	10/60	9,76



## IVR 364



Tappo per radiatori con valvola automatica di sfogo aria, nichelato  
Automatic air-vent for radiators, nickel-plated  
Entlüftungsventil für Heizkörper vernickelt - Automatisches Entlüftung  
Vanne purgeur d'air pour radiateur - automatique / nickelée  
Заглушка для радиаторов с никелированным автоматическим воздухоотводчиком

Cod./Code	Mod./Model	Mis./Size	□/田	€
136410001	Dx/Right	1"	10/50	9,11
136410002	Sx/Left	1"	10/50	9,11
136412001	Dx/Right	1"1/4	10/60	11,06
136412002	Sx/Left	1"1/4	10/60	11,06



## IVR 367



Valvola sfogo aria per radiatori manuale, nichelata  
Manual Air-vent for radiators, Nickel-plated  
Entlüftungsventil für Heizkörper vernickelt, - Manuelles Entlüftung  
Vanne purgeur d'air nickelée pour radiateur - vanne manuel  
Ручной воздухоотводчик для радиаторов, никелированный

Cod./Code	Mis./Size	□/田	€
136702001	1/4"	100/1000	1,10
136703001	3/8"	100/800	1,40
136705001	1/2"	75/450	1,93



## IVR 833



Valvola sfogo aria per radiatori manuale con tenuta P.T.F.E. nichelata  
Air-vent for radiators, nickel-plated - Manual with P.T.F.E. seal  
Entlüftungsventil für Heizkörper vernickelt - Manuelles Entlüftung - mit P.T.F.E. - Dichtung  
Vanne purgeur d'air pour radiateur, nickelée - Vanne manuelle avec tenue en P.T.F.E.  
Ручной воздухоотводчик для радиаторов, никелированный с уплотнением P.T.F.E.

Cod./Code	Mis./Size	□/田	€
183303001	3/8"	100/600	1,59
183305001	1/2"	50/600	2,18



## IVR 837



Rubinetto d'intercettazione per valvola automatica di sfogo aria  
Shut-off valve for automatic air vent  
Absperrentil für automatisches Entlüftungsventil  
Robinet de sectionnement pour la vanne de purge de l'air  
Отсекающий кран для автоматического воздухоотводчика

Cod./Code	Mis./Size	□/田	€
183703031	3/8" x 3/8"	50/900	1,56
183703051	3/8" x 1/2"	50/750	2,56
183705051	1/2" x 1/2"	50/750	2,06



## IVR 838



Valvola sfogo aria per radiatore manuale / orientabile, nichelata  
Air-vent for radiators, nickel-plated - Manual / Orientable  
Entlüftungsventil für Heizkörper vernickelt, - Manuelles Entlüftung - einstellbar  
Vanne purgeur d'air pour radiateur, nickelée - Vanne manuelle de purge d'air orientable  
Воздухоотводчик ручной / регулируемый для радиаторов, никелированный

Cod./Code	Mis./Size	□/田	€
183803001	3/8"	100/1200	1,48
183805001	1/2"	500	1,48



## VALVOLE BOCCHETTONE PER COLLETTORI VALVES WITH TAIL PIECE FOR MANIFOLDS

### IVR 984/A



Valvola a sfera a passaggio totale con bocchettone porta termometro e termometro, attacchi M/F, sede conica, con autotenuta e farfalla rossa

Full bore ball valve with thermometer-holder and thermometer, M/F, conical seat, auto-seal tailpiece and red butterfly handle

Kugelhahn mit vollem Durchgang, Thermometeranschluss und Thermometer, AG/IG, Kegelsitz, Selbstdichtung und rotem Flügelgriff

Vanne à boisseau sphérique avec fixation thermomètre et thermomètre, F/F, siège conique, auto-étanche et poignée papillon rouge

Кран шаровой полнопроходной с соединением под термометр в комплекте с термометром, соединение Н/В, коническое седло, отвод с герметичной прокладкой, красная ручка-бабочка.

Cod./Code	Mis./Size	□/田	€
198410008	1"	1/15	32,04



### IVR 984/B



Valvola a sfera a passaggio totale con bocchettone porta termometro e termometro- attacchi M/F, sede conica, con autotenuta e farfalla blu

Full bore ball valve with thermometer holder and thermometer, M/F, conical seat, auto-seal tailpiece and blue butterfly handle

Kugelhahn mit vollem Durchgang, Thermometeranschluss und Thermometer, AG/IG, Kegelsitz, Selbstdichtung und blauem Flügelgriff

Vanne à boisseau sphérique avec fixation thermomètre et thermomètre, M/F, siège conique, auto-étanche et poignée papillon bleue

Кран шаровой полнопроходной с соединением под термометр в комплекте с термометром, соединение Н/В, коническое седло, отвод с герметичной прокладкой, голубая ручка-бабочка.

Cod./Code	Mis./Size	□/田	€
198410211	1"	1/15	32,04



### IVR 986/A



Valvola a sfera a passaggio standard a squadra, attacco termometro, bocchettone autotenuta, nichelata. Maniglia farfalla rossa. Sede conica

Angle ball valve with standard bore, thermometer connection, auto-seal tail piece, nickel-plated. Red butterfly handle. Conical seat

Eckkugelhahn mit vollem Durchgang, Thermometeranschluss, Selbstdichtung, vernickelt. Kegelsitz

Vanne à boisseau sphérique équerre, fixation pour thermomètre, auto-étanche, nickelée. Poignée papillon rouge. Siège conique

Угловой кран со стандартным проходом и соединением для термометра, отвод с герметичной прокладкой, никелированный. Красная ручка-бабочка. Коническое седло.

Cod./Code	Mis./Size	□/田	€
198610008	1"	1/15	39,97



### IVR 986/B



Valvola a sfera a passaggio standard a squadra, attacco termometro, bocchettone autotenuta, nichelata. Maniglia farfalla blu. Sede conica.

Angle ball valve with standard bore, thermometer connection, auto-seal tail piece, nickel-plated. Blue butterfly handle. Conical seat.

Eckkugelhahn mit Standardbohrung, Thermometeranschluss, Selbstdichtung, vernickelt. Blauer Flügelgriff. Kegelsitz.

Vanne à boisseau sphérique équerre, fixation pour thermomètre, auto-étanche, nickelée. Poignée papillon bleue. Siège conique.

Угловой кран со стандартным проходом и соединением для термометра, отвод с герметичной прокладкой, никелированный. Голубая ручка-бабочка. Коническое седло.

Cod./Code	Mis./Size	□/田	€
198610211	1"	1/15	39,97





## IVR 980/A



Valvola a sfera a passaggio totale con bocchettone - attacchi M/F, sede piana, con autotenuta, farfalla rossa  
Full bore ball valve with tail piece - M/F, red butterfly handle - 3/4" - Auto seal connection  
Kugelhahn mit Durchgangsbohrung mit Stutzen - Stecker/Buchse-Anschlüsse, Flachdichtend, rote Flügelgriff  
Vanne à bille à passage total avec raccords M/F, siège plat, avec autoétanche, poignée papillon rouge  
Шаровой кран с полным проходом со штуцером - соединения M/F, плоское седло, с самоуплотнением, красная бабочка

Cod./Code	Mis./Size	□/田	€
198010008	1"	10/40	25,64
198012008	1"1/4	8/32	47,12



## IVR 980/B



Valvola a sfera a passaggio totale con bocchettone - attacchi M/F, sede piana, con autotenuta, farfalla blu  
Full bore ball valve with tail piece - M/F, blue butterfly handle - 3/4" - Auto seal connection  
Kugelhahn mit Durchgangsbohrung mit Stutzen - Stecker/Buchse-Anschlüsse, Flachdichtend, blaue Flügelgriff  
Vanne à bille à passage total avec raccords M/F, siège plat, avec autoétanche, poignée papillon bleue  
Шаровой кран полнопроходной со штуцером - соединения M/F, плоское седло, с самоуплотнением, синяя ручка "бабочка"

Cod./Code	Mis./Size	□/田	€
198010211	1"	10/40	25,64
198012211	1"1/4	8/32	47,12



## IVR 981/A



Valvola a sfera a passaggio standard a squadra con bocchettone - attacchi M/F, sede conica, con autotenuta, farfalla rossa  
Angle standard bore ball valve with tail piece - M/F, with conical seat, auto-seal and red butterfly handle  
Kugelhahn eckförmig, mit Standarddurchgang, Rohrverschraubung - AG/IG, mit Kegelsitz, Selbstdichtung und rotem Flügelgriff  
Vanne à boisseau sphérique à passage standard équerre avec raccord - fixations M/F, avec siège conique, auto-étanche et poignée papillon rouge  
Угловой шаровой кран с накидной гайкой, стандартный проход - соединения Н/В, с коническим седлом и герметичной прокладкой, красная ручка "бабочка"

Cod./Code	Mis./Size	□/田	€
198110008	1"	6/24	32,56



## IVR 981/B



Valvola a sfera a passaggio standard a squadra con bocchettone - attacchi M/F, sede conica, con autotenuta, farfalla blu  
Angle standard bore ball valve with tail piece - M/F, with conical seat, auto-seal and blue butterfly handle  
Kugelhahn eckförmig mit Standarddurchgang, Rohrverschraubung - AG/IG, mit Kegelsitz, Selbstdichtung und blauem Flügelgriff  
Vanne à boisseau sphérique à passage standard équerre avec raccord - fixations M/F, avec siège conique, auto-étanche et poignée papillon bleue  
Угловой шаровой кран с накидной гайкой, стандартный проход - соединения Н/В, с коническим седлом и герметичной прокладкой, синяя ручка "бабочка"

Cod./Code	Mis./Size	□/田	€
198110211	1"	6/24	32,56



## IVR 982/A



Valvola a sfera a passaggio totale con bocchettone - attacchi M/F, sede conica, con autotenuta e farfalla rossa  
Full bore ball valve with tail piece - M/F, with conical seat, auto-seal and red butterfly handle

Kugelhahn mit vollem Durchgang und Rohrverschraubung - AG/IG, mit Kegelsitz, Selbstdichtung und rotem Flügelgriff

Vanne à boisseau sphérique à passage intégral avec raccord M/F, siège conique, auto-étanche et poignée papillon rouge

Полнопроходной шаровой кран со сгоном и накидной гайкой - соединения Н/В, с коническим седлом, герметичная прокладка, красная ручка "бабочка"

Cod./Code	Mis./Size	□/田	€
198205058	1/2" x 1/2"	10/120	10,24
198207078	3/4" x 3/4"	10/60	15,29
198207108	3/4" x 1"	10/60	17,42
198210108	1" x 1"	10/40	26,16



## IVR 982/B



Valvola a sfera a passaggio totale con bocchettone - attacchi M/F, sede conica, con autotenuta e farfalla blu  
Full bore ball valve with tail piece - M/F, with conical seat and auto-seal and blue butterfly handle

Kugelhahn mit vollem Durchgang und Rohrverschraubung - AG/IG, mit Kegelsitz, Selbstdichtung und blauem Flügelgriff

Vanne à boisseau sphérique à passage intégral avec raccord M/F, siège conique auto-étanche et poignée papillon bleue

Полнопроходной шаровой кран со сгоном и накидной гайкой - соединения Н/В, с коническим седлом, герметичная прокладка, синяя ручка "бабочка"

Cod./Code	Mis./Size	□/田	€
198205061	1/2" x 1/2"	10/120	10,24
198207081	3/4" x 3/4"	10/60	15,29
198207111	3/4" x 1"	10/60	17,42
198210111	1" x 1"	10/40	26,16



## IVR 206/A



Valvola a sfera a passaggio totale con dado folle - attacchi F/F, sede piana farfalla rossa

Full bore ball valve with swivel nut - F/F, with conical seat and red butterfly handle

Kugelhahn mit Durchgangsbohrung und freier Mutter - IG/IG-Anschlüsse, flacher Sitz, rote Flügelgriff

Vanne à bille à passage total avec écrou libre - raccords F/F, emplacement plat, poignée papillon rouge

Полнопроходной шаровой кран с накидной гайкой - соединения F/F, плоское седло, красная бабочка

Cod./Code	Mis./Size	□/田	€
120605108	1/2" x 3/4"	10/60	14,25
120607078	3/4" x 3/4"	10/60	14,31
120607108	3/4" x 1"	10/40	17,08
196410008	1" x 1"	10/40	25,12



## IVR 206/B



Valvola a sfera a passaggio totale con dado folle - attacchi F/F, sede piana farfalla blu

Full bore ball valve with swivel nut - F/F couplings, flat sealing, blue butterfly handle

Kugelhahn mit Durchgangsbohrung und freier Mutter - IG/IG-Anschlüsse, blaue Flügelgriff

Vanne à bille à passage total avec écrou libre - raccords F/F, emplacement plat, poignée papillon bleue

Полнопроходной шаровой кран с накидной гайкой - соединения F/F, плоское седло, синяя бабочка

Cod./Code	Mis./Size	□/田	€
120605111	1/2" x 3/4"	10/60	14,25
120607081	3/4" x 3/4"	10/60	14,31
120607111	3/4" x 1"	10/40	17,08
196410211	1" x 1"	10/40	25,12





## IVR 205/A



Valvola a sfera a passaggio totale con dado folle - attacchi M/F - sede piana, farfalla rossa  
Full bore ball valve with swivel nut - M/F, with flat seat and red butterfly handle  
Kugelhahn mit vollem Durchgang und lockerer Schraube - AG/IG, mit Flachsitz und rotem Flugelgriff  
Vanne à boisseau sphérique à passage intégral avec écrou - avec fixations M/F, siège plate et poignée papillon rouge  
Полнопроходной шаровой кран с накидной гайкой - соединения Н/В, с плоским седлом, красная ручка бабочка

Cod./Code	Mis./Size	□/田	€
120505078	1/2" x 3/4"	10/60	14,25
120507218	3/4" x 1"	10/40	18,34



## IVR 205/B



Valvola a sfera a passaggio totale con dado folle - attacchi M/F - sede piana, farfalla blu  
Full bore ball valve with swivel nut - M/F, with flat seat and blue butterfly handle  
Kugelhahn mit vollem Durchgang und lockerer Schraube - AG/IG, mit Flachsitz und blauem Flugelgriff  
Vanne à boisseau sphérique à passage intégral avec écrou - avec fixations M/F, siège plate et poignée papillon bleue  
Полнопроходной шаровой кран с накидной гайкой - соединения Н/В, с плоским седлом, синяя ручка бабочка

Cod./Code	Mis./Size	□/田	€
120505212	1/2" x 3/4"	10/60	14,16
120507221	3/4" x 1"	10/40	18,34



## IVR 206/B R



Valvola a sfera a passaggio totale con ritegno incorporato e dado folle - attacchi F/F, farfalla blu  
Full bore ball valve with check valve with swivel nut - F/F couplings, blue butterfly handle  
Kugelhahn mit Durchgangsbohrung und Feststellmutter - Buchse/Buchse-Anschlüsse, blaue Flugelgriff  
Vanne à bille à passage total avec clapet anti-retour avec écrou libre - raccords F/F, poignée papillon bleue  
Полнопроходной шаровой кран с накидной гайкой и запором - соединения F/F, синяя бабочка

Cod./Code	Mis./Size	□/田	€
120607281	3/4"	10/60	16,78

## IVR 827/A



Valvola a sfera a passaggio totale, attacchi M/F, sede piana, farfalla rossa  
Full bore ball valve - M/F, with flat seat and red butterfly handle  
Kugelhahn mit vollem Durchgang AG/IG, mit Flachsitz und rotem Flugelgriff  
Vanne à boisseau sphérique à passage intégral, fixations M/F, avec siège plate et poignée papillon rouge  
Полнопроходной шаровой кран, соединения Н/В, с плоским седлом, красная ручка "бабочка"

Cod./Code	Mis./Size	□/田	€
182707002	3/4" x 1"	10/120	9,97



## IVR 827/B



Valvola a sfera a passaggio totale, attacchi M/F, sede piana, farfalla blu  
Full bore ball valve - M/F, with flat seat and blue butterfly handle  
Kugelhahn mit vollem Durchgang, AG/IG, mit Flachsitz und blauem Flugelgriff  
Vanne à boisseau sphérique à passage intégral, fixations M/F, avec siège plate et poignée papillon bleue  
Полнопроходной шаровой кран, соединения Н/В, с плоским седлом, синяя ручка "бабочка"

Cod./Code	Mis./Size	□/田	€
182707011	3/4" x 1"	10/120	9,97



## IVR 86/A



Valvola a sfera a passaggio totale, attacchi M/F, sede conica, farfalla rossa  
Full bore ball valve, M/F, with conical seat and red butterfly handle  
Kugelhahn mit vollem Durchgang, AG/IG, mit Kegelsitz und rotem Flügelgriff  
Vanne à boisseau sphérique à passage intégral, fixations M/F, avec siège conique et poignée papillon rouge  
Полнопроходной шаровой кран, соединения Н/В, с коническим седлом, красная ручка "бабочка"

Cod./Code	Mod./Model	Mis./Size	Att./Conn.	□/田	€
108607102	Rossa - Red	3/4"	1"	10/60	9,79



## IVR 86/B



Valvola a sfera a passaggio totale, attacchi M/F, sede conica, farfalla blu  
Full bore ball valve, M/F, with conical seat and blue butterfly handle  
Kugelhahn mit vollem Durchgang, AG/IG, mit Kegelsitz und blauem Flügelgriff  
Vanne à boisseau sphérique à passage intégral avec fixations M/F, siège conique et poigné papillon bleue  
Полнопроходной шаровой кран, соединения Н/В, с коническим седлом, синяя ручка "бабочка"

Cod./Code	Mod./Model	Mis./Size	Att./Conn.	□/田	€
108607104	Blu - Blue	3/4"	1"	10/60	9,79



## IVR 820



Termometro con guaina completo per IVR 979/A - IVR 979/B  
Thermometer with pocket for IVR 979/A - IVR 979/B  
Thermometer mit Hülle für IVR 979/A - IVR 979/B  
Thermomètre avec gaine complète pour IVR 979/A - IVR 979/B  
Термометр с кожухом для IVR 979/A - IVR 979/B

Cod./Code	Mod./Model	Mis./Size	□/田	€
182003001	Diametro 41	3/8"	10/150	10,45



## IVR 985



Bocchettone portatermometro orientabile con termometro  
Rotating thermometer-holder tail piece with thermometer  
Drehbarer Thermometeranschluss mit Thermometer  
Fixation thermomètre orientable avec thermomètre  
Муфта для термометра в комплекте с термометром

Cod./Code	Mis./Size	□/田	€
198510001	1" x 1 1/4"	4/48	16,76





## VALVOLE PORTASONDA PER COLLETTORI VALVE WITH SENSOR CONNECTION FOR MANIFOLDS

### IVR 954 S



Valvola a sfera a passaggio totale - attacchi F/F - con portasonda  
Full bore ball valve - threaded ends F/F - with sensor connection  
Kugelhahn mit vollem Durchgang - IG/IG - mit Anschlüssen für Temperaturfühler  
Vanne a sphère a passage total - fixations F/F - avec fixation sonde pour température  
Полнопроходной шаровой кран: соединения В/В - с выводом для зонда

Cod./Code	Mod./Model	Mis./Size	□/田	€
195405711	M 10 x 1	1/2"	15/90	9,67
195407711	M 10 x 1	3/4"	20/80	12,19
195410711	M 10 x 1	1"	12/48	19,70



### IVR 944 AS



Valvola a sfera a passaggio totale con portasonda e bocchettone autotenuta. Sede conica M/F  
Full bore ball valve with sensor connection and auto seal tail piece. Conical seat M/F  
Kugelhahn mit vollem Durchgang, mit Anschluss für Temperatursonde und Selbstdichtung. Kegelsitz AG/IG  
Vanne à boisseau sphérique avec passage total, avec raccord pour sonde pour température et auto-étanche M/F  
Полнопроходной шаровой кран со штоком, самогерметизирующейся прокладкой и соединением для зонда. Коническое седло Н/В

Cod./Code	Mod./Model	Mis./Size	□/田	€
194407078	M 10 x 1	3/4" x 3/4"	10/40	22,90
194407108	M 10 x 1	3/4" x 1"	10/40	24,64
194410108	M 10 x 1	1" x 1"	10/40	31,25



### IVR 809/A



Valvola a sfera M/F con bocchettone, termometro e attacco sonda per temperatura, sede conica, farfalla rossa  
Ball valve M/F with tail piece with thermometer and connection for temperature sensor, conical seat, red butterfly handle  
Kugelhahn AG/IG, mit Rohrverschraubung, Thermometer und Anschluss für Temperaturfühler, Kegelsitz, roter Flügelgriff  
Vanne à boisseau sphérique M/F avec raccord, thermomètre et fixation sonde pour température, siège conique, poignée papillon rouge  
Шаровой кран с накидной гайкой соединения Н/В, с термометром и соединением для температурного зонда, с коническим седлом, красная ручка "бабочка"

Cod./Code	Mod./Model	Mis./Size	Ø	□/田	€
180910002	M10 x 1	1"	23	10/40	40,78



### IVR 809/B



Valvola a sfera M/F con bocchettone, termometro e attacco sonda per temperatura, sede conica, farfalla blu  
Ball valve M/F with tail piece, thermometer and connection for temperature sensor, conical seat, blue butterfly handle  
Kugelhahn AG/I mit Rohrverschraubung, Thermometer und Anschluss für Temperaturfühler, Kegelsitz, roter Flügelgriff  
Vanne à boisseau sphérique M/F avec raccord, thermomètre et fixation sonde pour température, siège conique, poignée papillon rouge  
Шаровой кран с накидной гайкой соединения Н/В, с термометром и соединением для температурного зонда, с коническим седлом, синяя ручка "бабочка"

Cod./Code	Mod./Model	Mis./Size	Ø	□/田	€
180910011	M10 x 1	1"	23	10/40	40,78



## IVR 979/A



Valvola a sfera M/F, attacco termometro, bocchettone autotenuta, nichelata. Per AVANT FLOOR. Maniglia farfalla rossa e attacco sonda per temperatura. Sede conica

Ball valve M/F with thermometer connection, tailpiece with auto-seal, nickel plated. For AVANT FLOOR. Red butterfly handle and sensor connection. Conical seat

Kugelhahn AG/IG, Thermometeranschluss, Rohrverschraubung mit Selbstdichtung, vernickelt für AVANT FLOOR. Roter Flügelgriff und Anschluss für Temperatursonde mit Kegelsitz.

Vanne à boisseau sphérique M/F, fixation thermomètre, raccord autoétanche, nickelée - pour AVANT FLOOR. Poignée papillon rouge et fixation sonde Vanne à boisseau sphérique M/F, fixation thermomètre, raccord autoétanche, nickelée - pour AVANT FLOOR. Poignée papillon rouge et fixation sonde pour température. Siège conique.

Шаровой кран Н/В, с соединением под термометер, со сгоном, самогерметизирующейся прокладкой, никелированный. Для AVANT FLOOR. Красная ручка-бабочка, с выводом для зонда. Коническое седло.

Cod./Code	Mod./Model	Mis./Size	□/田	€
197910108	M10 x 1	1"	1/15	37,45



## IVR 979/B



Valvola a sfera M/F, attacco termometro, bocchettone autotenuta, nichelata. Per AVANT FLOOR. Maniglia farfalla blu e attacco sonda per temperatura. Sede conica

Ball valve M/F with thermometer connection, tail piece with auto-seal, nickel plated. For AVANT FLOOR. Blue butterfly handle and sensor connection. Conical seat.

Kugelhahn AG/IG, Thermometeranschluss, Rohrverschraubung mit Selbstdichtung, vernickelt für AVANT FLOOR. Blauer Flügelgriff und Anschluss für Temperatursonde mit Kegelsitz.

Vanne à boisseau sphérique M/F, fixation thermomètre, raccord autoétanche, nickelée - pour AVANT FLOOR. Poignée papillon bleue et fixation sonde pour température. Siège conique.

Шаровой кран Н/В, с соединением под термометер, со сгоном, самогерметизирующейся прокладкой, никелированный. Для AVANT FLOOR. Синяя ручка-бабочка, с выводом для зонда. Коническое седло.

Cod./Code	Mis./Size	□/田	€
197910311	1"	1/15	37,45



## TESTA TERMOELETTRICA THERMO SUNNY THERMOELECTRIC ACTUATOR THERMO SUNNY

### IVR 823



Testa termoelettrica fornita nella versione NC (normalmente chiusa) o NO (normalmente aperta) per AVANT FLOOR - 230 V

Thermo-electric actuator, version NC (normally closed position) or NO (normally open position) for AVANT FLOOR SS manifolds - 230 V

Thermoelektrischer Kopf, erhältlich in den Ausführungen NC (normalerweise geschlossen) - NO (normalerweise geöffnet) - für AVANT FLOOR - 230 V

Tête thermoélectrique fournie dans la version NC (normalement fermée) - NO (normalement ouverte) AVANT FLOOR - 230 V

Термоэлектродвигатель, NC (нормально закрытый) или NO (нормально открытый) для коллекторов AVANT FLOOR - 230 V

Cod./Code	Mod./Model	Att./Conn.	□/⊞	€
182311101	NC	M30 x 1,5	1/25	33,95
182311112	NO	M30 x 1,5	1/25	35,22
182311140	NC C/MICRO 4 FILI	M30 x 1,5	1/25	44,59



### IVR 824



Testa termoelettrica fornita nella versione NC (normalmente chiusa) o NO (normalmente aperta) per AVANT FLOOR - 24 V

Thermo-electric actuator, version NC (normally closed position) or NO (normally open position) for AVANT FLOOR - 24 V

Thermoelektrischer Kopf, erhältlich in den Ausführungen NC (normalerweise geschlossen) - NO (normalerweise geöffnet) - für AVANT FLOOR - 24 V

Tête thermoélectrique fournie dans la version NC (normalement fermée) - NO (normalement ouverte) AVANT FLOOR - 24 V

Термоэлектродвигатель, NC (нормально закрытый) или NO (нормально открытый) для коллекторов AVANT FLOOR - 24 V

Cod./Code	Mod./Model	Att./Conn.	□/⊞	€
182411101	NC	M30 x 1,5	1/25	37,76
182411110	NO	M30 x 1,5	1/25	39,71
182411140	NC C/MICRO 4 FILI	M30 x 1,5	1/25	49,70



### IVR 456



Adattatore per il collegamento delle teste termoelettriche IVR 823 e IVR 824 ai collettori in tecnopolimero IVR 902 e IVR 902 KIT A

Adapter for connecting the IVR 823 and IVR 824 thermo-electric heads to polymer manifolds IVR 902 and IVR 902 KIT A

Adapter zum Anschließen der thermoelektrischen Köpfe IVR 823 und IVR 824 an die Technopolymerverteiler IVR 902 und IVR 902 KIT A.

Adaptateur pour connecter les têtes thermoélectriques IVR 823 et IVR 824 aux collecteurs en technopolymère IVR 902 et IVR 902 KIT A

Адаптер для подключения термоэлектрических головок IVR 823 и IVR 824 к технополимерным коллекторам IVR 902 и IVR 902 КОМПЛЕКТ А

Cod./Code	Att./Conn.	□/⊞	€
145600050	M30 x 1,5	25/375	2,28

## ACCESSORI PER COLLETTORI ACCESSORIES FOR MANIFOLDS

### IVR 825 D



Termostato ambiente a parete digitale 230 V o 24 V - NO / NC  
Digital wall-mounted room thermostat 230V o 24V - NO / NC  
Digitales Raumthermostat mit Wandbefestigung 230V o 24 V - NO / NC  
Thermostat ambiente digital fixé au mur 230V o 24 V - NO / NC  
Настенный электронный термостат для жилых помещений 230 V o 24 V - NO / NC

Cod./Code	Mod./Model	□/⊞	€
182521501	230V	1/50	104,69
182524501	24V	1/50	111,67



### IVR 825



Termostato ambiente a parete 24-230 V - NO/NC  
Room thermostat 24-230 V - NO/NC  
Raumthermostat als Wandausführung 24-230 V - NO/NC  
Thermostat ambient mural 24-230 V - NO/NC  
Настенный термостат для жилых помещений 24-230 V - NO/NC

Cod./Code	□/⊞	€
182500010	1/25	22,00
182524011	1/50	39,11



### IVR 408/1 K



Kit estensione per AVANT FLOOR IVR 802 IVR 804  
Extension Kit for AVANT FLOOR IVR 802 IVR 804  
Extension Kit für AVANT FLOOR IVR 802 IVR 804  
Kit d'extension pour AVANT FLOOR IVR 802 IVR 804  
Дополнительный комплект для AVANT FLOOR IVR 802 IVR 804

Cod./Code	Mod./Model	Mis./Size	Vie/Ways	□/⊞	€
140820571	IVR 802 - IVR 804	1"	1	1/15	41,09



### IVR 408/2 K



Kit estensione per AVANT FLOOR IVR 803 IVR 805  
Extension Kit for AVANT FLOOR IVR 803 IVR 805  
Extension Kit für AVANT FLOOR IVR 803 IVR 805  
Kit d'extension pour AVANT FLOOR IVR 803 IVR 805  
Дополнительный комплект для AVANT FLOOR IVR 803 IVR 805

Cod./Code	Mod./Model	Mis./Size	Vie/Ways	□/⊞	€
140820576	IVR 803 - IVR 805	1"	1	1/15	42,04





## IVR 408/3 K



Kit estensione per AVANT FLOOR IVR 800 IVR 806  
Extension Kit for AVANT FLOOR IVR 800 IVR 806  
Extension Kit für AVANT FLOOR IVR 800 IVR 806  
Kit d'extension pour AVANT FLOOR IVR 800 IVR 806  
Дополнительный комплект для AVANT FLOOR IVR 800 IVR 806

Cod./Code	Mod./Model	Mis./Size	Vie/Ways	□/田	€
140820580	IVR 800 - IVR 806	1"	1	1/18	34,29



## IVR 408/4 K



Kit estensione per AVANT FLOOR IVR 801 IVR 807  
Extension Kit for AVANT FLOOR IVR 801 IVR 807  
Extension Kit für AVANT FLOOR IVR 801 IVR 807  
Kit d'extension pour AVANT FLOOR IVR 801 IVR 807  
Дополнительный комплект для AVANT FLOOR IVR 801 IVR 807

Cod./Code	Mod./Model	Mis./Size	Vie/Ways	□/田	€
140820581	IVR 801 - IVR 807	1"	1	1/18	35,24



## IVR 408/5 K



Kit estensione per AVANT FLOOR  
Extension Kit for AVANT FLOOR  
Extension Kit für AVANT FLOOR  
Kit d'extension pour AVANT FLOOR  
Дополнительный комплект для AVANT FLOOR

Cod./Code	Mod./Model	Mis./Size	Vie/Ways	□/田	€
140820590	Tutti i collettori/ All Manifolds	1"	1	1/18	32,80



## IVR 408/6 K



Kit estensione per AVANT FLOOR  
Extension Kit for AVANT FLOOR  
Extension Kit für AVANT FLOOR  
Kit d'extension pour AVANT FLOOR  
Дополнительный комплект для AVANT FLOOR

Cod./Code	Mod./Model	Mis./Size	Vie/Ways	□/田	€
140820591	Tutti i collettori/ All Manifolds	1"	1	1/15	48,62



## IVR 408/7 K



Kit estensione per AVANT FLOOR  
Extension Kit for AVANT FLOOR  
Extension Kit für AVANT FLOOR  
Kit d'extension pour AVANT FLOOR  
Дополнительный комплект для AVANT FLOOR

Cod./Code	Mod./Model	Mis./Size	Vie/Ways	□/田	€
140820592	Tutti i collettori/ All Manifolds	1"	1	1/15	40,68



## IVR 836



Rubinetto orientabile di carico-scarico  
Water fill/drain valve  
Ausrichtbares Ein-/Ablassventil von Wasser  
Robinet orientable de chargement/déchargement de l'eau  
Регулируемый дренажный клапан

Cod./Code	Mis./Size	□/田	€
183605001	1/2"	10/120	6,68



## IVR 836/I



Rubinetto orientabile inclinato di carico-scarico  
Rotating angle fill/drain valve  
Drehbares Ein-/Anlassventil  
Robinet orientable de chargement/déchargement  
Регулируемый угловой дренажный клапан

Cod./Code	Mis./Size	□/田	€
183605100	1/2"	10/120	5,79



## IVR 836/P



Rubinetto orientabile inclinato di carico-scarico in tecnopolimero  
Rotating angle fill / drain valve in polymer  
Drehbares Ein-/Anlassventil aus Technopolymere  
Robinet orientable de chargement/déchargement en technopolymère  
Регулируемый угловой дренажный клапан из технополимера

Cod./Code	Mis./Size	□/田	€
183605161	1/2"	10/120	4,65



## IVR 897



Termometro a contatto per AVANT FLOOR  
Contact thermometer for AVANT FLOOR manifolds  
Kontaktthermometer für AVANT FLOOR  
Thermomètre à contact pour AVANT FLOOR  
Контактный термометр для коллекторов AVANT FLOOR

Cod./Code	Mod./Model	□/田	€
189700010	Diametro 40	1/120	9,74



## IVR 847 A



Guscio isolante aperto 12 uscite superiori ed inferiori per AVANT FLOOR  
Insulating shell with upper and lower 12 ways for AVANT FLOOR manifolds  
Geöffnete Isolierhülse mit 12 oberen und unteren Ausgängen für Verteiler AVANT FLOOR  
Coque isolante ouverte pour 12 sorties inférieures et supérieures pour AVANT FLOOR  
Изоляция открытая, на 12 выходов верх и низ, для коллекторов AVANT FLOOR

Cod./Code	Mis./Size	L (mm)	H (mm)	□/田	€
1847A1012	1"	36	69	10	25,87
1847A1212	1"1/4	36	69	10	25,87

## IVR 847 C



Guscio isolante chiuso 12 uscite inferiori per AVANT FLOOR  
Insulating shell with 12 lower ways for AVANT FLOOR manifolds  
Geschlossene Isolierhülse mit 12 unteren Ausgängen für Verteiler AVANT FLOOR  
Coque isolante "fermée" pour 12 sorties inférieures pour AVANT FLOOR  
Изоляция закрытая на 12 нижних выходов для коллекторов AVANT FLOOR

Cod./Code	Mis./Size	L (mm)	H (mm)	□/⊞	€
1847C1012	1"	36	69	10	25,87
1847C1212	1"1/4	36	69	10	25,87

## IVR 411



Raccordo terminale M con autotenuta, nichelato  
Manifold T plug Nickel-plated - M with auto-seal with 2 F connectons  
Endanschluss. Vernickelt - AG mit Selbstdichtung  
Raccord terminal. Nickelé - M avec auto-étanche  
Торцевая заглушка никелированная для коллектора с наружной резьбой и самоуплотнителем.

Cod./Code	Mis./Size	□/⊞	€
141107531	3/4" M x 1/2" x 3/8"	10/150	5,83
141110531	1" M x 1/2" x 3/8"	10/150	7,49
141112531	1"1/4 M x 1/2" x 3/8"	10/100	7,87
141191055	1" M x 1/2" x 1/2"	25/100	9,43

## IVR 408



Raccordo terminale M con autotenuta e dado, nichelato  
Manifold T plug. Nickel-plated - M with Auto-seal and nut 2 F 1/2" Connctcions  
Endanschluss - vernickelt - AG - mit Selbstdichtung und Überwurfmutter  
Raccord Terminal, nickelé - M avec joint et écrou  
Концевое никелированное соединение для коллектора с наружной резьбой, гайкой и самогерметизацией

Cod./Code	Mis./Size	□/⊞	€
140810551	1" M x 1/2" x 1/2"	15/180	7,58

## IVR 405



Niples con autotenuta, nichelato  
Nickel-plated auto-seal MM nipple  
Vernickeltes Nippel mit Selbstdichtung  
Raccords avec auto-étanche nickelés  
Ниппель с самогерметизацией, никелированный.

Cod./Code	Mis./Size	□/⊞	€
140507001	3/4"	10/180	5,77
140510001	1"	25/150	5,83
140512001	1"1/4	10/150	9,07

## IVR 407



Niples orientabile con autotenuta, nichelato  
Nickel-plated adjustable nipple with auto-seal  
Drehbares vernickeltes Nippel mit Selbstdichtung  
Raccords orientables avec auto-étanche nickelés  
Регулируемый ниппель с самогерметизацией, никелированный.

Cod./Code	Mis./Size	□/⊞	€
140710001	1"	10/150	10,18
140712001	1"1/4	10/120	17,07

## IVR 311



Raccordo in tre pezzi con autotenuta e sede conica, dritto, nichelato  
Three-piece fitting with auto seal. Nickel-plated - straight. Conical seat - M/F  
Dreiteiliger Anschluss mit Selbstdichtung. Vernickelt - gerade. Kegelsitz  
Raccord en trois pièces avec auto-étanche. Nickelé - droit. Siège conique  
Трехсоставной фитинг с самогерметизацией, никелированный - прямой с коническим седлом.

Cod./Code	Mis./Size	□/田	€
131107001	3/4"	10/120	21,21
131110001	1"	10/40	29,64



## IVR 316



Raccordo in tre pezzi con autotenuta e sede conica, a gomito, nichelato  
Three pieces fitting with auto seal. Nickel-plated - elbow M/F  
Dreiteiliger winkel Anschluss - selbstdichtend - vernickelt  
Raccord trois pièces autoétanche, nickelé - Courbé  
Трехсоставной фитинг с самогерметизацией, никелированный с коническим седлом, согнут под прямым углом.

Cod./Code	Mis./Size	□/田	€
131607001	3/4"	10/100	19,15
131610001	1"	10/40	25,57



## IVR 412



Tappo F - nichelato  
F plug - Nickel-plated  
Deckel IG - vernickelt  
Bouchon F nickelé  
Никелированная заглушка с внутренней резьбой

Cod./Code	Att./Conn.	□/田	€
141204001	24-19	50/750	2,25
141205001	1/2"	50/900	1,95
141207001	3/4"	50/750	2,28
141210001	1"	25/375	3,52
141212001	1"1/4	200	4,19

## IVR 414



Tappo M per collettore nichelato  
M plug with O-ring. Nickel-plated. Suitable for AVANT FLOOR manifolds.  
Deckel AG. Vernickelt  
Bouchon M. Nickelé  
Никелированная заглушка с наружной резьбой для коллекторов.

Cod./Code	Mis./Size	□/田	€
141405001	1/2"	50/900	1,69
141407001	3/4"	50/750	2,18
141410001	1"	50/500	2,23
141412001	1"1/4	50/200	6,04

## IVR 415



Riduzione M/F nichelata  
M/F Size reducer fitting. Nickel-plated  
Deckel AG/IG. Vernickelt  
Bouchon M/F. Nickelé  
Фитинг Н/В - никелированный

Cod./Code	Mis./Size	□/田	€
141507031	3/4" M x 3/8" F	50/750	2,28
141507051	3/4" M x 1/2" F	50/750	2,28
141510031	1" M x 3/8" F	50/400	4,00
141510051	1" M x 1/2" F	50/400	4,58
141510071	1" M x 3/4" F	50/500	3,44
141512051	1"1/4 M x 1/2" F	50/200	7,42
141512101	1"1/4 M x 1" F	50/200	5,52

## IVR 822



Etichette autoadesive  
Stickers for AVANT FLOOR manifold loops  
Klebeetiketten  
Étiquettes autocollantes  
Стикеры

Cod./Code	□/田	€
182200001	100/1200	0,62

## IVR 821



Set di 2 zanche doppie di fissaggio antivibrazione per AVANT FLOOR  
Set of 2 twin anti-vibration mounting brackets for AVANT FLOOR manifolds  
Garnitur mit 2 doppelten schwingungsdämpfenden Befestigungsklammern für AVANT FLOOR  
Kit de 2 doubles plaques d'ancrage antivibration pour AVANT FLOOR  
Комплект из двух двойных антивибрационных кронштейнов для AVANT FLOOR

Cod./Code	Mod./Model	Mis./Size	S (mm)	L (mm)	□/田	€
182100030	h S1 27	1"	44	200	1/50	10,12
182100032	h S1 32	1"1/4	49	200	1/20	10,68

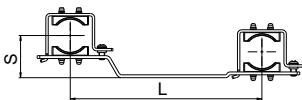

## IVR 821 U



Staffe multifunzionali universali per collettori in ottone ed acciaio, interasse regolabile da min di 200 mm a un max di 285 mm, profondità regolabile del morsetto da max H 70 mm - mid H 58,5 mm - min H 47 mm  
Universal multi-functional brackets for manifolds in brass and steel, adjustable centre distance from min of 200 mm to max di 285 mm, adjustable depth max H 70 mm - mid H 58.5 mm - min H 47 mm  
Universelle Multifunktionshalterungen für Verteiler aus Messing und Stahl, Achsabstand einstellbar von min 200 mm bis max 285 mm, Einstelltiefe Klemme von max H 70 mm - mittel H 58,5 mm - min H 47 mm  
Étriers multifonction universels pour collecteurs en laiton et acier, entraxe réglable de min 200 mm à un max de 285 mm, profondeur réglable de l'étau de max H 70 mm - mid H 58,5 mm - min H 47 mm  
Универсальные многофункциональные скобы для коллекторов из латуни и стали, регулируемый шаг от мин. 200 мм до макс. 285 мм, регулируемая глубина зажима от макс. H 70 мм - средн. H 58,5 мм - мин. H 47 мм

Cod./Code	Mis./Size	L (mm)	□/田	€
182100100	1"	200	1/50	12,10

## IVR 840



Set di 2 zanche singole di fissaggio antivibrazione per AVANT FLOOR  
Set of 2 single anti-vibration mounting brackets for AVANT FLOOR manifolds  
Garnitur mit 2 einzigen schwingungsdämpfenden Befestigungsklammern für AVANT FLOOR  
Kit de 2 plaques simples d'ancrage antivibration pour AVANT FLOOR  
Комплект из двух отдельных антивибрационных кронштейнов для AVANT FLOOR

Cod./Code	Mis./Size	□/田	€
184010050	1"	10/40	7,99
184010052	1"	10/40	7,94
184012050	1"1/4	10/40	6,57
184012052	1"1/4	10/40	7,94

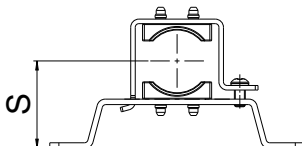



## IVR 830

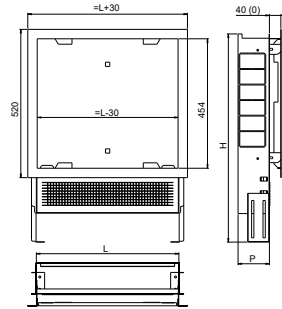

Armadio universale in acciaio zincato in lamiera preverniciata RAL 9010 per alloggiamento collettore. Include: base incasso, 2 kit guide regolabili (regolazione consentita: da 0 a 100 mm), frontalino con rete elettrosaldata anche sul dorso per facilitare l'aggrappaggio dell'intonaco; porta e cornice in lamiera preverniciata RAL 9010 regolabile in profondità (regolazione consentita: da 0 a 50 mm).

Adjustable galvanised steel cabinet in pre-primed sheet metal RAL 9010 designed to place the manifold. It includes: base for jointing, nr. 2 adjustable feet (adjustment from 0 to 100mm), net electrically welded to make plastering easier; door and frame in pre-primed sheet metal RAL 9010 with adjustable depth (from 0 to 50 mm).

Universal Schrank aus verkrümmtem rostfreiem Stahl aus lackierter Metallschicht RAL 9010 für Verteiler. Ausgestattet mit: Fuss für Montage, 2 Kits von verstellbaren Führungsschienen, 2 verstellbaren Füßchen (von 0 bis zum 100mm), elektrogeschweißtem Netz vorne und hinten zu einem guten Verputzen; Tur und Rahmen aus lackierter Metallschicht RAL 9010 mit verstellbarer Tiefe (von 0 bis zum 50 mm).

Armoire universel en acier galvanisé en tôle avec une couche de vernis RAL 9010 pour mettre le collecteur. Il inclut: la base pour le montage, 2 kits de coulisseaux réglables, 2 pieds réglables (de 0 à 100 mm), une grille électrosoudée arrière et derrière faciliter l'accrochage de l'enduit; porte et corniche en tôle avec une couche de vernis RAL 9010 avec la profondeur réglable (de 0 à 50 mm).

Универсальный шкаф из оцинкованной стали с полимерным покрытием RAL 9010 предназначен для монтажа коллекторов. В комплекте: основа; 2 набора регулируемых реек; 2 регулируемые ножки (регулировка по высоте от 0 до 100мм); передняя панель с электросварной сеткой, задняя панель для облегчения адгезии штукатурки; выдвигаемая рамка и дверца в покраске RAL 9010 с регулируемой глубиной установки (от 0 до 50 мм)

Cod./Code	Vie/Ways	L (mm)	H (mm)	P (mm)	□/田	€
1830040009	3+3	400	630	90	1	118,64
1830050009	5+5	500	630	90	1	126,75
1830060009	7+7	600	630	90	1	143,98
1830070009	9+9	700	630	90	1	154,57
1830085009	12+12	850	630	90	1	184,78
1830100009	13+13	1000	630	90	1	208,56
1830120009		1200	630	90	1	234,67
1830130009		1300	630	90	1	250,92
183004001	3+3	400	630	110	1	120,10
1830050011	5+5	500	630	110	1	128,10
183006001	7+7	600	630	110	1	145,61
183007001	9+9	700	630	110	1	156,08
1830085011	12+12	850	630	110	1	186,34
183010001	13+13	1000	630	110	1	210,25
183012001		1200	630	110	1	236,13
1830130011		1300	630	110	1	252,38
1830100015		1000	630	150	1	220,29
1830120015		1200	630	150	1	246,89
1830130015		1300	630	150	1	264,53



## IVR 831



Cassetta in plastica universale per collettori, con set supporto collettori - per IVR 872-873-874

Plastic cabinet, with manifolds mounting set - for IVR 872-873-874

Universalgehäuse aus Plastik für Verteiler, mit Verteilerhalterungsset - für IVR 872-873-874

cassette en plastique universelle pour collecteurs, avec set support collecteurs - pour IVR 872-873-874

Универсальный пластиковый шкаф с монтажным набором - для коллекторов IVR 872-873-874

Cod./Code	L (mm)	H (mm)	P (mm)	□/田	€
183103201	347	290	90	1/8	22,85
183104001	427	290	90	1/8	25,45
183105001	527	290	90	1/8	28,67
183106001	627	290	90	1/8	34,15



## IVR MULTIKLIMA - MISCELAZIONE IVR MULTIKLIMA - MIXING UNIT

### IVR 711



Gruppo di miscelazione a punto fisso con testa termostatica IVR; disponibile con circolatore classe A (IVR 711/A), con circolatore a 3 velocità (IVR 711/C) o senza circolatore (IVR 711/S).

Fixed point mixing unit with IVR thermostatic head; available with A-Class circulating pump (IVR711/A), with 3-speed circulating pump (IVR711/C) or without pump (IVR711/S).

Fest eingestellte Mischerguppe mit Thermostatkopf IVR; verfügbar mit Zirkulationspumpe der Klasse A (IVR711/A), mit Zirkulationspumpe mit 3 Geschwindigkeitsstufen (IVR711/C) oder ohne Zirkulationspumpe (IVR711/S).

Groupe de mélange à point fixe avec tête thermostatique; disponible avec circulateur Classe A (IVR711/A), avec circulateur à 3 vitesses (IVR711/C) ou sans circulateur (IVR711/S).

Смесительная группа с фиксированной точкой и термостатической головкой IVR.

Cod./Code	Mod./Model	Series	Mis./Size	□/田	€
171115000	int. 277 mm	711/S	3/4" x 1"	1/4	138,46
171115001	int. 277 mm	711/C	3/4" x 1"	1	325,17
171115007	int. 277 mm	711/A	3/4" x 1"	1	477,39



### IVR 712



Gruppo di miscelazione a punto fisso con miscelatore termostatico; disponibile con circolatore classe A (IVR 712/A), con circolatore a 3 velocità (IVR 712/C) o senza circolatore (IVR 712/S).

Fixed point mixing unit with thermostatic mixing valve; available with A-Class circulating pump (IVR712/A), with 3-speed circulating pump (IVR712/C) or without pump (IVR712/S).

Fest eingestellte Mischerguppe mit Thermostatmischer; verfügbar mit Zirkulationspumpe der Klasse A (IVR712/A), mit Zirkulationspumpe mit 3 Geschwindigkeitsstufen (IVR712/C) oder ohne Zirkulationspumpe (IVR712/S).

Groupe de mélange à point fixe avec mitigeur thermostatique; disponible avec circulateur Classe A (IVR712/A), avec circulateur à 3 vitesses (IVR712/C) ou sans circulateur (IVR712/S).

Смесительная группа с фиксированной точкой и термостатическим смесителем.

Cod./Code	Mod./Model	Series	Mis./Size	□/田	€
171215000	int. 277 mm	712/S	3/4" x 1"	1/4	267,98
171215001	int. 277 mm	712/C	3/4" x 1"	1	455,11
171215007	int. 277 mm	712/A	3/4" x 1"	1	608,20



### IVR 714



Gruppo by-pass con valvola di regolazione micrometrica e termostato di sicurezza (taratura 50° C)

By-pass unit with micrometric regulating valve and safety thermostat (set at 50° C).

Bypass-Gruppe mit mikrometrischem Einstellventil und Sicherheitsthermostat (eingestellt um 50°)

Groupe by-pass avec vanne de réglage micrométrique et thermostat de sécurité (réglé à 50° C)

Группа бай-пасс с регулирующим микрометрическим клапаном и предохранительным термостатом(калибровка 50° C).

Cod./Code	Mod./Model	Mis./Size	□/田	€
171410501	int. 277 mm c/termostato	1"	1	121,93
171410502	int. 277 mm	1"	1	84,33
171410601	int. 200 mm c/termostato	1"	1	121,37
171410602	int. 200 mm	1"	1	84,33



## IVR 714/R



Raccordo 3 pezzi portasonda per gruppi di miscela IVR 711  
Three-piece sensor connection for mixing units IVR 711  
Dreiteiliger Anschluss für Mischerguppen IVR 711  
Raccord à trois pièces pour groupes de mélange IVR 711  
Трехсоставной фитинг для смесительной группы IVR 711

Cod./Code	Mis./Size	□/田	€
171431001	1"	8/48	23,29

## IVR 330



Separatore idraulico in acciaio inox Aisi 304 completo di raccordi  
Hydraulic separator in stainless steel AISI 304 with unions  
Hydraulische Weiche aus rostfreiem Stahl AISI 304 mit Anschlüssen  
Séparateur hydraulique en acier inoxydable AISI 304 avec raccords  
Гидравлический сепаратор из нержавеющей стали AISI 304 в комплекте с фитингами

Cod./Code	Mis./Size	□/田	€
133027701	1" M x 1" F	1	237,74



## IVR 330/C



Guscio di coibentazione per separatore idraulico  
Isolation for hydraulic separator  
Isolierung für hydraulische Weiche  
Isolation pour le séparateur hydraulique  
Изолирующая оболочка для гидравлического сепаратора

Cod./Code	Mod./Model	□/田	€
335800420	Per Art IVR 330	5	30,62

## IVR VALVOLE ATTACCO POMPA IVR VALVES WITH PUMP CONNECTION

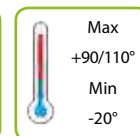

## IVR 108



Valvola a sfera con filetto F e con calotta per attacco pompa e circolatori  
Ball valve with F thread and swivel nut for pump connection  
Pumpen-Kugelhahn mit IG - Überwurfmutter  
Vanne à boisseau sphérique avec écrou tournant pour pompe  
Шаровой кран с внутренней резьбой и накладной гайкой для соединения с циркуляционным насосом

Cod./Code	Mis./Size	Ø	□/田	€
110810001	1" F x 1"1/2 F	19	50	10,82





## IVR 109



Valvola a sfera con attacco tubo rame e calotta per attacco pompa e circolatori  
Ball valve with copper pipe connection and loose nut for pump connection  
Pumpen-Kugelhahn mit Kompression-Anschluss für Kupferrohr und Überwurfmutter  
Vanne à boisseau sphérique avec raccord à compression pour tube cuivre et écrou tournant pour pompe  
Шаровой кран для насосов с соединением для медной трубы и накидной гайкой для соединения с насосом

Cod./Code	Mis./Size	Ø	□/田	€
110900221	22 x 1"1/2 F	19	50	10,50
110900281	28 x 1"1/2 F	19	50	12,10



## IVR 380



Valvola a sfera con filetto F e con calotta per attacco pompa e circolatori  
Ball valve with F thread and loose nut for pump connection  
Pumpen-Kugelhahn - IG - Überwurfmutter  
Vanne à boisseau sphérique avec écrou tournant pour pompe  
Шаровой кран для насосов с накидной гайкой и соединением для циркуляционного насоса

Cod./Code	Mis./Size	Ø	□/田	€
138010002	1" F x 1"1/2 F	20	10/40	18,16



## IVR 381



Valvola a sfera con filetto F e con calotta + ritegno per attacco pompa e circolatori  
Ball valve + non return device with F thread and loose nut for pump connection  
Pumpenkugelhahn IG und Überwurfmutter + Schwerkraftbremse für Pumpe und Zirkulatoren  
Vanne à boisseau sphérique avec fixation F et écrou tournant + anti-retour pour fixation pompe et circulateurs  
Шаровой кран с внутренней резьбой и накидной гайкой + обратный клапан для соединения с циркуляционным насосом

Cod./Code	Mis./Size	Ø	□/田	€
138110002	1" F x 1"1/2 F	20	10/40	19,75



## IVR 382



Valvola a sfera con filetto F e con calotta + ritegno (disattivabile) per attacco pompa e circolatori  
Ball valve with + adjustable anti-return option - F thread and loose nut for circulating pump connection  
Pumpenkugelhahn IG und Überwurfmutter + abschaltbarer Schwerkraftbremse für Pumpe und Zirkulatoren  
Vanne à boisseau sphérique avec fixation F et écrou tournant + anti-retour (désactivable) pour pompe et circulateurs  
Шаровой кран с внутренней резьбой и накидной гайкой + обратный клапан (отключаемый) для соединения с циркуляционным насосом

Cod./Code	Mis./Size	Ø	□/田	€
138210002	1" F x 1"1/2 F	20	10/40	21,22



## COLLETTORI PREMONTATI CON MISCELAZIONE PRE-ASSEMBLED MANIFOLDS WITH MIXING UNIT

### MISCELAZIONE CON TESTA TERMOSTATICA A PUNTO FISSO

#### IVR MK 511 CV



Disponibile con entrata  
da destra o da sinistra

\*Modulo di distribuzione per bassa temperatura con collettori in acciaio inox AISI 304 da 1" x 3/4" EK, da 2 a 12 derivazioni completi di: valvola d'intercettazione, valvole termostattizzabili, misuratori di portata, rubinetto orientabile di carico scarico, valvola sfiato aria. Gruppo di miscelazione a punto fisso con testa termostatica, gruppo by-pass con termostato di sicurezza, detentore micrometrico e pozzetto porta sonda. Versione con circolatore volumetrico Classe A.

\*Water distribution cabinet for low temperature with AISI 304 stainless steel manifolds 1"x3/4" EK, 2-12 ways; fitted with: interception valve, thermostatic valves, flow meters, rotatable drain valves and air vent. Mixing unit with fixed point with thermostatic head, by-pass group with safety thermostat, micrometric lockshield and sensor connection. Version with volumetric pump Class A.

\*prezzi su richiesta  
 \*prices upon request

#### IVR MK 512 CV



Disponibile con entrata  
da destra o da sinistra

\*Modulo di distribuzione per bassa temperatura, con separatore idraulico in acciaio inox, con collettori in acciaio inox AISI 304 da 1" x 3/4" EK, da 2 a 12 derivazioni completi di: valvola d'intercettazione, valvole termostattizzabili, misuratori di portata, rubinetto orientabile di carico scarico, valvola sfiato aria. Gruppo di miscelazione a punto fisso con testa termostatica, gruppo by-pass con termostato di sicurezza, detentore micrometrico e pozzetto porta sonda. Versione con circolatore volumetrico Classe A.

\*Water distribution cabinet for low temperature with stainless steel hydraulic separator and with AISI 304 stainless steel manifolds 1"x3/4" EK, 2-12 ways; fitted with: interception valve, thermostatic valves, flow meters, rotatable drain valves and air vent. Mixing unit with fixed point with thermostatic head, by-pass group with safety thermostat, micrometric lockshield and sensor connection. Version with volumetric pump Class A.

\*prezzi su richiesta  
 \*prices upon request

#### IVR MK 521 CV



Disponibile con entrata  
da destra o da sinistra

\*Modulo di distribuzione per alta e bassa temperatura con collettori in acciaio inox AISI 304 da 1" x 3/4" EK, da 2 a 12 derivazioni con 2 derivazioni (o 3 su richiesta) per alta temperatura; collettori completi di: valvole d'intercettazione, valvole termostattizzabili, misuratori di portata, rubinetto orientabile di carico scarico, valvola sfiato aria. Gruppo di miscelazione a punto fisso con testa termostatica e gruppo by-pass con termostato di sicurezza, detentore micrometrico e pozzetto porta sonda. Versione con circolatore volumetrico Classe A.

\*Water distribution cabinet for high and low temperature with AISI 304 stainless steel manifolds 1"x3/4" EK, 2-12 ways; with 2 ways (or 3 on demand) for high temperature; fitted with: interception valves, thermostatic valves, flow meters, rotatable drain valve and air vent. Mixing unit with fixed point with thermostatic head and by-pass group with safety thermostat, micrometric lockshield and sensor connection. Version with volumetric pump Class A.

\*prezzi su richiesta  
 \*prices upon request



## COLLETTORI PREMONTATI CON MISCELAZIONE PRE-ASSEMBLED MANIFOLDS WITH MIXING UNIT

### MISCELAZIONE CON MISCELATORE TERMOSTATICO

#### IVR MK 513 CV



Disponibile con entrata  
da destra o da sinistra

\*Modulo di distribuzione per bassa temperatura con collettori in acciaio inox AISI 304 da 1" x 3/4" EK, da 2 a 12 derivazioni completi di: valvola d'intercettazione, valvole termostattizzabili, misurscarico, valvola sfiato aria. Gruppo di miscelazione a punto fisso con miscelatore termostatico, gruppo by-pass con termostato di sicurezza, detentore micrometrico e pozzetto porta sonda. Versione con circolatore volumetrico Classe A.

\*Water distribution cabinet for low temperature with AISI 304 stainless steel manifolds 1"x3/4" EK, 2-12 ways - fitted with: interception valve, thermostatic valves, flow meters, rotatable drain valve, thermostatic mixing valve, by-pass group with safety thermostat, micrometric lockshield and sensor connection. Version with volumetric pump Class A.

\*prezzi su richiesta  
\*prices upon request

#### IVR MK 514 CV



Disponibile con entrata  
da destra o da sinistra

\*Modulo di distribuzione per bassa temperatura, con separatore idraulico in acciaio inox, con collettori in acciaio inox AISI 304 da 1" x 3/4" EK, da 2 a 12 derivazioni completi di: valvola d'intercettazione, valvole termostattizzabili, misuratori di portata, rubinetto orientabile di carico scarico, valvola sfiato aria. Gruppo di miscelazione a punto fisso con miscelatore termostatico, gruppo by-pass con termostato di sicurezza, detentore micrometrico e pozzetto porta sonda. Versione con circolatore volumetrico Classe A.

\*Water distribution cabinet for low temperature with stainless steel hydraulic separator and with AISI 304 stainless steel manifolds 1"x3/4" EK, 2-12 ways; fitted with: interception valve, thermostatic valves, flow meters, rotatable drain valves and air vent. Mixing unit with fixed point with thermostatic mixing valve, by-pass group with safety thermostat, micrometric lockshield and sensor connection. Version with volumetric pump Class A.

\*prezzi su richiesta  
\*prices upon request

#### IVR MK 523 CV



Disponibile con entrata  
da destra o da sinistra

\*Modulo di distribuzione per alta e bassa temperatura con collettori in acciaio inox AISI 304 da 1" x 3/4" EK da 2 a 12 derivazioni con 2 derivazioni (o 3 su richiesta) per alta temperatura - collette termostattizzabili, misuratori di portata, rubinetto orientabile di carico scarico, valvola sfiato aria. Gruppo di miscelazione a punto fisso con miscelatore termostatico e gruppo by-pass con termostato di sicurezza, detentore micrometrico e pozzetto porta sonda. Versione con circolatore volumetrico Classe A.

\*Water distribution cabinet for high and low temperature with AISI 304 stainless steel manifolds 1"x3/4" EK, 2-12 ways - with 2 ways (or 3 on demand) for high temperature - fitted with: interception drain valve and air vent. Mixing unit with fixed point with thermostatic head and by-pass group with safety thermostat, micrometric lockshield and sensor connection. Version with volumetric pump Class A.

\*prezzi su richiesta  
\*prices upon request

## COLLETTORI INDUSTRIALI - INOX

### INDUSTRIAL MANIFOLDS - INOX

#### IVR 882

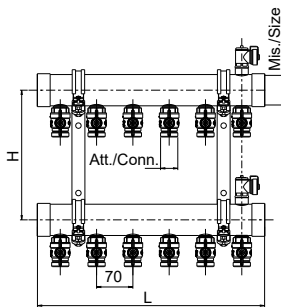

Collettore Industriale in acciaio inox AISI 304 1"1/2 - 2", interasse 70 mm., trattamento di elettrolucidatura, con rubinetto carico/scarico acqua (adattatore da 1") e valvola a sfera d'intercettazione

Stainless steel AISI 304 Industrial Manifold 1"1/2 - 2", center hole distance 70 mm., electro-polished treatment, with draining valve (adapter connection 1") and shut off valves

Industrie-Verteiler aus rostfreiem Edelstahl AISI 304 1"1/2"- 2" - Abstand 70 mm., Elektropoliturbehandlung, mit Ein-Ablassventil (1" Zwischenstück / Adapter) und Absperrventil

Collecteur Industriel en acier inox AISI 304 1"1/2 - 2", entreaxe 70 mm, traitement d'électropolissage, avec robinet de charge/déchargement (adaptateur 1") et vanne à boisseau sphérique de sectionnement

Индустриальный коллектор из нержавеющей стали AISI 304, диаметр 1"1/2 - 2", электрополированный, межосевое расстояние 70мм, с отсекающим шаровым краном и дренажным краном для адаптера 1".

Cod./Code	Mis./Size	Vie/Ways	L (mm)	H (mm)	Att./Conn.	□/田	€
188242704	1"1/2	4	291	250	1" M	1	352,62
188242705	1"1/2	5	361	250	1" M	1	369,19
188242706	1"1/2	6	431	250	1" M	1	418,47
188242707	1"1/2	7	501	250	1" M	1	467,15
188242708	1"1/2	8	571	250	1"	1	528,77
188242709	1"1/2	9	641	250	1" M	1	581,14
188242710	1"1/2	10	711	250	1" M	1	633,01
188242711	1"1/2	11	781	250	1" M	1	682,37
188242712	1"1/2	12	851	250	1" M	1	740,18
188242713	1"1/2	13	921	250	1" M	1	790,72
188242714	1"1/2	14	991	250	1" M	1	855,87
188252704	2"	4	299	250	1" M	1	359,00
188252705	2"	5	369	250	1" M	1	422,71
188252706	2"	6	439	250	1" M	1	482,84
188252707	2"	7	509	250	1" M	1	523,91
188252708	2"	8	579	250	1" M	1	573,37
188252709	2"	9	649	250	1" M	1	628,62
188252710	2"	10	719	250	1" M	1	691,31
188252711	2"	11	789	250	1" M	1	739,92
188252712	2"	12	859	250	1" M	1	796,63
188252713	2"	13	929	250	1" M	1	811,73
188252714	2"	14	999	250	1" M	1	895,65



## IVR 883

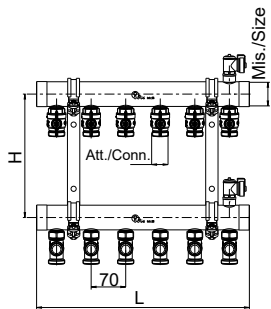

Collettore Industriale in acciaio inox AISI 304 1"1/2 - 2", interasse 70 mm., trattamento di elettrolucidatura, con rubinetto carico/scarico acqua (adattatore da 1") e valvola a sfera d'intercettazione e detentore micrometrico  
Stainless steel AISI 304 Industrial Manifold 1"1/2 - 2", center hole distance 70 mm., electro-polished treatment, with fill/drain valve (adapter connection 1") isolating valves and micrometric lockshield

Industrie-Verteiler aus rostfreiem Edelstahl AISI 304 1"1/2" - 2" - Abstand 70 mm., Elektropoliturbehandlung, mit Ein-Ablassventil (1" Zwischenstück / Adapter) und Absperventil und mikrometrischem Rücklaufverschraubung  
Collecteur industriel en acier inox AISI 304 1"1/2 - 2", entreaxe 70 mm, traitement d'électropolissage, avec robinet de charge/déchargement (adaptateur 1") et vanne à boisseau sphérique de sectionnement et coude de réglage micrométrique

Индустриальный коллектор из нержавеющей стали AISI 304, диаметр 1"1/2 - 2", электрополированный, межосевое расстояние 70мм, с отсекающим шаровым краном, дренажным краном для адаптера 1" и микрометрическим отсекающим вентиляем

Cod./Code	Mis./Size	Vie/Ways	L (mm)	H (mm)	Att./Conn.	□/田	€
188342704	1"1/2	4	291	250	1" M	1	351,49
188342705	1"1/2	5	361	250	1" M	1	366,15
188342706	1"1/2	6	431	250	1" M	1	414,84
188342707	1"1/2	7	501	250	1" M	1	462,91
188342708	1"1/2	8	571	250	1" M	1	526,54
188342709	1"1/2	9	641	250	1" M	1	578,63
188342710	1"1/2	10	711	250	1" M	1	630,21
188342711	1"1/2	11	781	250	1" M	1	675,71
188342712	1"1/2	12	851	250	1" M	1	736,83
188342713	1"1/2	13	921	250	1" M	1	782,85
188342714	1"1/2	14	991	250	1" M	1	851,95
188352704	2"	4	299	250	1" M	1	356,58
188352705	2"	5	369	250	1" M	1	421,32
188352706	2"	6	439	250	1" M	1	481,15
188352707	2"	7	509	250	1" M	1	521,97
188352708	2"	8	579	250	1" M	1	571,13
188352709	2"	9	649	250	1" M	1	626,11
188352710	2"	10	719	250	1" M	1	685,25
188352711	2"	11	789	250	1" M	1	736,86
188352712	2"	12	859	250	1" M	1	793,29
188352713	2"	13	929	250	1" M	1	808,10
188352714	2"	14	999	250	1" M	1	891,53



## IVR 884

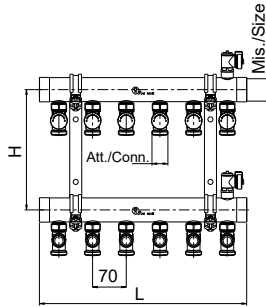

Collettore Industriale in acciaio inox AISI 304 1"1/2 - 2", interasse 70 mm., trattamento di elettrolucidatura, con rubinetto carico/scarico acqua (adattatore da 1") e valvola termostattabile, cappello di regolazione e detentore micrometrico

Stainless steel AISI 304 Industrial Manifold 1"1/2 - 2", center hole distance 70 mm., electro-polished treatment, with fill/drain valve (adapter connection 1") thermostatic valve, operating plastic cap and micrometric lockshield

Industrie-Verteiler aus rostfreiem Edelstahl AISI 304 1"1/2 - 2" - Abstand 70 mm., Elektropoliturbehandlung, mit Ein-Ablassventil (1" Zwischenstück / Adapter), thermostatisierbarem Ventil, Einstellkappe und mikrometrischer Rücklaufverschraubung

Collecteur Industriel en acier inox AISI 304 1"1/2 - 2", entgreaxe 70 mm, traitement d'électropolissage, avec vanne à boisseau sphérique de sectionnement (adaptateur 1"), robinet de charge/déchargement et vanne thermostatique micrométrique

Индустриальный коллектор из нержавеющей стали AISI 304, диаметр 1"1/2 - 2", электрополированный, межосевое расстояние 70мм, с термостатическим клапаном, дренажным крапом для адаптера 1", регулирующим колпачком и микрометрическим отсекающим вентиляем

Cod./Code	Mis./Size	Vie/Ways	L (mm)	H (mm)	Att./Conn.	□/田	€
188442704	1"1/2	4	291	250	1" M	1	358,94
188442705	1"1/2	5	361	250	1" M	1	373,58
188442706	1"1/2	6	431	250	1" M	1	423,76
188442707	1"1/2	7	501	250	1" M	1	473,29
188442708	1"1/2	8	571	250	1" M	1	541,42
188442709	1"1/2	9	641	250	1" M	1	595,39
188442710	1"1/2	10	711	250	1" M	1	648,82
188442711	1"1/2	11	781	250	1" M	1	692,04
188442712	1"1/2	12	851	250	1" M	1	759,16
188442713	1"1/2	13	921	250	1" M	1	802,13
188442714	1"1/2	14	991	250	1" M	1	878,01
188452704	2"	4	299	250	1" M	1	362,50
188452705	2"	5	369	250	1" M	1	430,63
188452706	2"	6	439	250	1" M	1	492,32
188452707	2"	7	509	250	1" M	1	534,97
188452708	2"	8	579	250	1" M	1	586,02
188452709	2"	9	649	250	1" M	1	642,85
188452710	2"	10	719	250	1" M	1	700,09
188452711	2"	11	789	250	1" M	1	757,32
188452712	2"	12	859	250	1" M	1	815,61
188452713	2"	13	929	250	1" M	1	832,29
188452714	2"	14	999	250	1" M	1	917,57



## IVR 893

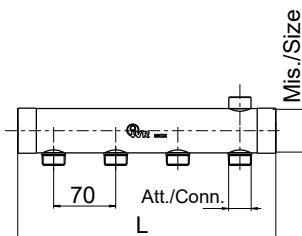

Collettore Industriale in acciaio inox AISI 304 1"1/2 - 2", interasse 70 mm., attacchi da 3/4", attacco per rubinetto carico/scarico, trattamento di elettrolucidatura

Stainless steel AISI 304 Industrial Manifold 1"1/2 - 2", outlet distance 70 mm, connections 3/4", draining valve connection, electropolished treatment

Industrie-Verteiler aus rostfreiem Edelstahl AISI 304 1"1/2 - 2" - Abstand 70 mm. Mit 3/4" Anschlüsse - Ein- und Ablassventil (1" Zwischenstück / Adapter), Elektropoliturbehandlung

Collecteur Industriel en acier inox AISI 304 1"1/2 - 2", entrax 70mm, fixations de 3/4", traitement d'électropolissage

Индустриальный коллектор из нержавеющей стали AISI 304 1"1/2 - 2", выходы 3/4", межосевое расстояние 70мм, соединение для дренажного крана, электрополировка

Cod./Code	Mis./Size	Vie/Ways	L (mm)	Att./Conn.	□/田	€
189342704	1"1/2	4	291	3/4" M	1/5	95,09
189342705	1"1/2	5	361	3/4" M	1/5	103,08
189342706	1"1/2	6	431	3/4" M	1/8	106,84
189342707	1"1/2	7	501	3/4" M	1/8	119,41
189342708	1"1/2	8	571	3/4" M	1/8	146,40
189342709	1"1/2	9	641	3/4" M	1/8	161,69
189342710	1"1/2	10	711	3/4" M	1/8	176,71
189342711	1"1/2	11	781	3/4" M	1/6	179,68
189342712	1"1/2	12	851	3/4" M	1/6	206,79
189342713	1"1/2	13	921	3/4" F	1/6	209,75
189342714	1"1/2	14	991	3/4" M	1/6	242,82
189352704	2"	4	299	3/4" M	1/10	97,94
189352705	2"	5	369	3/4" M	1/10	123,88
189352706	2"	6	439	3/4" M	1/10	141,89
189352707	2"	7	509	3/4" M	1/5	151,52
189352708	2"	8	579	3/4" M	1/5	165,35
189352709	2"	9	649	3/4" M	1/5	182,08
189352710	2"	10	719	3/4" M	1/5	193,25
189352711	2"	11	789	3/4" M	1/5	215,92
189352712	2"	12	859	3/4" M	1/5	232,48
189352713	2"	13	929	3/4" M	1	229,11
189352714	2"	14	999	3/4" M	1	260,07



## IVR 462

Collettore in acciaio inox AISI 304 da 1"1/2 - 2", con attacchi M/M da 1/2", interasse 110 mm - adatto per contatore acqua

Stainless steel AISI 304 MANIFOLD 1"1/2 - 2" - connections M/M 1/2", center hole distance 110 mm - for water meter

Verteiler aus rostfreiem Stahl AISI 304 - 1"1/2 - 2" - alle Anschlüsse AG/AG 1/2", Abstand 110 mm - geeignet für Wasserzähler

Collecteur en acier inox AISI 304 de 1"1/2 - 2" - avec fixations M/M de 1/2", entraxe 110 mm pour compteur pour eau

Коллектор из нержавеющей стали AISI 304 1"1/2 - 2", выходы 1/2" Н/Н, межосевое расстояние 110 мм, для счетчиков воды

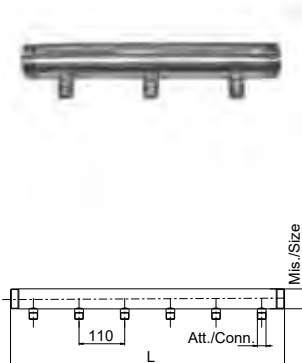

Cod./Code	Mis./Size	Vie/Ways	Att./Conn.	□/田	€
146240502	1"1/2	2	1/2" M	1/5	59,52
146240503	1"1/2	3	1/2" M	1/5	75,56
146240504	1"1/2	4	1/2" M	1/5	89,00
146240505	1"1/2	5	1/2" M	1/10	100,17
146240506	1"1/2	6	1/2" M	1/10	111,19
146240507	1"1/2	7	1/2" M	1/5	114,73
146240508	1"1/2	8	1/2" M	1/6	135,73
146240509	1"1/2	9	1/2" M	1/6	149,43
146240510	1"1/2	10	1/2" M	1/6	157,49
146250502	2"	2	1/2" M	1/10	66,90
146250503	2"	3	1/2" M	1/10	77,98
146250504	2"	4	1/2" M	1/5	88,03
146250505	2"	5	1/2" M	1/5	98,20
146250506	2"	6	1/2" M	1/5	108,25
146250507	2"	7	1/2" M	1/5	120,71
146250508	2"	8	1/2" M	1/5	130,77
146250509	2"	9	1/2" M	1/5	143,50
146250510	2"	10	1/2" M	1/5	172,41



## IVR 463

Collettore in acciaio inox AISI 304 da 1"1/2 - 2", con attacchi M/M da 1/2", interasse 110 mm - adatto per contatore acqua con attacchi contrapposti

Stainless steel AISI 304 manifold 1"1/2 - 2" - connections M/M 1/2", center hole distance 110 mm - for water meter with twin connections

Verteiler aus rostfreiem Stahl AISI 304 - 1"1/2 - 2" - alle Anschlüsse AG/AG 1/2", Abstand 110 mm - geeignet für Wasserzähler mit Parallelanschlüssen

Collecteur en acier inox AISI 304 de 1"1/2 - 2" - avec fixations M/M de 1/2", entraxe 110 mm pour compteur pour eau avec fixations parallèles

Коллектор из нержавеющей стали AISI 304, диаметр 1"1/2 - 2", выходы 1/2" Н/Н, межосевое расстояние 110 мм, для счетчиков воды с противоположными соединениями

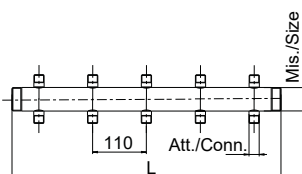

Cod./Code	Mis./Size	Vie/Ways	L (mm)	Att./Conn.	□/田	€
146340503	1"1/2	3+3	330	1/2" M	1/5	119,20
146340504	1"1/2	4+4	440	1/2" M	1/5	147,38
146340505	1"1/2	5+5	550	1/2" M	1/10	173,18
146350503	2"	3+3	334	1/2" M	1/10	133,36
146350504	2"	4+4	444	1/2" M	1/10	158,97
146350505	2"	5+5	554	1/2" M	1/10	184,55





## ACCESSORI COLLETTORI INDUSTRIALI ACCESSORIES FOR INDUSTRIAL MANIFOLDS

### IVR 406



Nipples in acciaio inox AISI 304. Per collettori IVR-INOX  
AISI 304 stainless steel MM connection. For manifolds IVR-INOX  
Nippel aus rostfreiem Edelstahl AISI 304. Für Verteiler IVR-INOX  
Raccords autoétanche en acier AISI 304. Pour collecteurs IVR-INOX  
Ниппели из нержавеющей стали AISI 304. Для коллекторов IVR-INOX

Cod./Code	Mis./Size	□/⊞	€
140615001	1"1/2	10/120	23,11
140620001	2"	10/40	21,43

### IVR 416



Tappo M in acciaio inox AISI 304. Per IVR-INOX  
Stainless steel AISI 304 M plug. For IVR-INOX  
Deckel AG aus rostfreiem Stahl AISI 304. Für IVR-INOX  
Bouchon M en acier inox AISI 304. Pour IVR-INOX  
Заглушка из нержавеющей стали AISI 304 с наружной резьбой. Для коллекторов IVR-INOX

Cod./Code	Mis./Size	□/⊞	€
141615001	1"1/2	10/120	21,32
141620001	2"	10/60	23,50

### IVR 417



Tappo F in acciaio inox AISI 304. Per IVR-INOX 462  
Stainless steel AISI 304 F plug. For IVR-INOX 462  
Deckel IG aus rostfreiem Stahl AISI 304. Für IVR-INOX 462  
Bouchon F en acier inox AISI 304. Pour IVR-INOX 462  
Заглушка из нержавеющей стали AISI 304 с внутренней резьбой. Для IVR-INOX 462

Cod./Code	Mis./Size	□/⊞	€
141715001	1"1/2	10/120	18,98
141720001	2"	10/120	20,48

### IVR 844

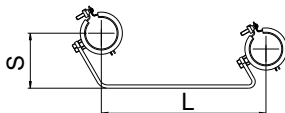

Zanca doppia per collettori. Per IVR-INOX  
Dual bracket for modular manifolds. For IVR-INOX  
Doppelklammern für Verteiler IVR-INOX  
Plaque d'ancrage double pour collecteurs. Pour IVR-INOX  
Двойной кронштейн для коллекторов IVR-INOX

Cod./Code	Mod./Model	Mis./Size	L (mm)	□/⊞	€
184415001	h S1 59	1"1/2	250	1/2	23,30
184420001	h S1 63	2"	250	1/2	28,17



### IVR 847 I



Guscio isolante. Per IVR-INOX  
Isolating shell for IVR-INOX  
Isolierhülse. Für Verteiler IVR-INOX  
Coque isolante. Pour collecteurs IVR-INOX  
Изолирующий элемент. Для IVR-INOX

Cod./Code	Mod./Model	Mis./Size	□/⊞	€
184715031	iniziale zanca - 3 uscite	1"1/2	10	25,69
184715032	intermedio - 3 uscite	1"1/2	10	25,69
184720031	iniziale zanca - 3 uscite	2"	10	26,62
184720032	intermedio - 3 uscite	2"	10	27,14

## VALVOLE TERMOSTATICHE - THERMOCHROME THERMOSTATIC VALVES - THERMOCHROME

### IVR 597 CHR



Testa termostatica con sensore a liquido - a bassa inerzia termica - Cromata, grigio scuro e grigio chiaro  
THERMOCHROME Thermostatic head with liquid sensor - low thermal inertia - Chrome-plated, dark grey and light grey

Thermostatkopf mit Flüssigkeitssensor - geringe thermische Trägheit - Verchromt, dunkelgrau und hellgrau

Tête thermostatique avec capteur à liquide - à faible inertie thermique - Chromée, dark grey et light grey

Термостатическая головка с жидкостным сенсором - с низкой термоинерцией. Хромированная, тёмно-серая, светло-серая.

Cod./Code	Series	Att./Conn.	□/田	€
159700701	Crom./Chrome	M30 x 1,5	1/50	26,25
159700704	Grigio sc/dark Grey	M30 x 1,5	1/50	26,25
159700705	Grigio Ch/Light Grey	M30 x 1,5	1/50	26,25

### IVR 777 CHR



KIT TERMOARREDO composto da valvola termostattabile e detentore, cromati. A squadra, attacco tubo rame, PEX e multistrato

THERMOCHROME KIT for design radiator with thermostatic valve and lockshield, chrome-plated. Angle, PEX, multilayer and copper pipe connection

DESIGNGARNITUR: Regulierventil (für Thermostat) und Rücklaufverschraubung, verchromt. Eckförmig, Anschluss für Kupfer, PEX und Mehrschichtrohr

KIT pour radiateurs design composé de vanne thermostatizable et coude de réglage chromés. Équerre, fixation tube en cuivre, PEX et multicouche

Комплект для дизайнерских радиаторов, состоящий из термостатического и отсекающего клапанов, хромированный. Угловой вентиль, соединение для медной, PEX и многослойной трубы

Cod./Code	Mis./Size	Att./Conn.	□/田	€
177705185	1/2"	24-19	1/15	47,46



### IVR 563 CHR



THERMOCHROME, valvola termostattabile a squadra, attacco PEX, multistrato e tubo rame, bocchettone autotenuta, cromata

THERMOCHROME, chrome-plated angle thermostatic valve, PEX, multilayer and copper pipe connection, auto seal tail piece

THERMOCHROME, Eckthermostatventil, Anschluss für PEX, Kupfer- und Mehrschichtrohr, mit Selbstdichtung, verchromt

THERMOCHROME, vanne thermostatizable équerre, fixation PEX, multicouche et tube en cuivre, raccord avec auto-étanche, chromée

THERMOCHROME, термостатический угловой клапан, соединение для PEX, металлопластиковой и стальной трубы. С самогерметизирующимся патрубком, хромированный.

Cod./Code	Mis./Size	Att./Conn.	□/田	€
156305187	1/2"	24-19	1/18	26,29

### IVR 557 CHR



THERMOCHROME, detentore a squadra, attacco PEX, multistrato e tubo rame, bocchettone autotenuta, cromato

THERMOCHROME, chrome-plated angle lockshield, PEX, multilayer and copper pipe connection, auto seal tail piece

THERMOCHROME, Eckrücklaufverschraubung, Anschluss für PEX, für Kupfer- und Mehrschichtrohr, mit Selbstdichtung, verchromt

THERMOCHROME, coude de réglage équerre, fixation PEX, multicouche et tube en cuivre, chromé

THERMOCHROME, угловой отсекающий клапан, соединение для PEX, металлопластиковой и стальной трубы. С самогерметизирующимся патрубком, хромированный

Cod./Code	Mis./Size	Att./Conn.	□/田	€
155705187	1/2"	24-19	1/18	20,63

## IVR 776 CHR



KIT TERMOARREDO composto da valvola termostattizzabile e detentore, cromati. Dritto, attacco tubo rame, PEX e multistrato

THERMOCHROME KIT for design radiator with thermostatic valve and lockshield, chrome-plated. Straight, PEX, multilayer and copper pipe connection

DESIGNGARNITUR: Regulierventil (für Thermostat) und Rücklaufverschraubung, verchromt. Gerade, Anschluss für Kupfer, PEX und Mehrschichtrohr

KIT pour radiateurs design composé de vanne thermostatisable et coude de réglage chromés. Droit, fixation tube en cuivre, PEX et multicouche

Комплект для дизайнерских радиаторов, состоящий из термостатического и отсекающего клапанов, хромированный. Прямой вентиль, соединение для медной, PEX и многослойной трубы

Cod./Code	Mis./Size	Att./Conn.	□/⊞	€
177605185	1/2"	24-19	1/15	50,15



## IVR 562 CHR



THERMOCHROME, valvola termostattizzabile diritta, attacco PEX, multistrato e tubo rame, bocchettone autotenuta, cromata

THERMOCHROME, chrome-plated straight thermostatic valve, PEX, multilayer and copper pipe connection, autoseal tail piece

THERMOCHROME, Gerade Thermostatventil, Anschluss für PEX, Kupfer- und Mehrschichtrohr, mit Selbstdichtung, verchromt

THERMOCHROME, vanne thermostatisable droite, fixation PEX, multicouche et tube en cuivre, raccord avec auto-étanche, chromée

THERMOCHROME, термостатический прямой клапан, соединение для PEX, металлопластиковой и стальной трубы. С самогерметизирующимся патрубком, хромированный.

Cod./Code	Mis./Size	Att./Conn.	□/⊞	€
156205187	1/2"	24-19	1/18	28,56

## IVR 555 CHR



THERMOCHROME, detentore dritto, attacco PEX, multistrato e tubo rame, bocchettone autotenuta, cromato

THERMOCHROME, chrome-plated straight lockshield, PEX, multilayer and copper pipe connection, autoseal tail piece

THERMOCHROME, Gerade Rücklaufverschraubung, Anschluss für PEX, für Kupfer- und Mehrschichtrohr, mit Selbstdichtung, verchromt

THERMOCHROME, coude de réglage droit, fixation PEX, multicouche et tube en cuivre, chromé

THERMOCHROME, прямой отсекающий клапан, соединение для PEX, металлопластиковой и стальной трубы. С самогерметизирующимся патрубком, хромированный.

Cod./Code	Mis./Size	Att./Conn.	□/⊞	€
155505187	1/2"	24-19	1/18	21,89

## IVR 774 CHR



KIT TERMOARREDO composto da valvola termostattizzabile e detentore, cromati. A squadra, fornita con adattatore per attacco tubo ferro

THERMOCHROME KIT for design radiator with thermostatic valve and lockshield, chrome-plated. Angle, iron pipe connection

DESIGNGARNITUR: Regulierventil (für Thermostat) und Rücklaufverschraubung, verchromt. Eckförmig, Anschluss für Eisenrohr

KIT pour radiateurs design composé de vanne thermostatisable et coude de réglage chromés. Équerre, fixation tube en cuivre

Комплект для дизайнерских радиаторов, состоящий из термостатического и отсекающего клапанов, хромированный. Угловой вентиль, соединение для стальной трубы

Cod./Code	Mis./Size	□/⊞	€
177405005	1/2"	1/15	66,95



## IVR 561 CHR



THERMOCHROME, valvola termostattabile a squadra, fornita con adattatore per attacco tubo ferro, bocchettone autotenuta, cromata

THERMOCHROME, chrome-plated angle thermostatic valve, iron pipe connection, autoseal tail piece

THERMOCHROME, eckförmiges Thermostatventil, Anschluss für Eisenrohr, mit Selbstdichtung, verchromt

THERMOCHROME, vanne thermostatisable équerre, fournie avec adaptateurs pour fixation tube en fer, raccord avec auto-étanche, chromée

THERMOCHROME, термостатический угловой клапан, поставляется с адаптером для стальной трубы, с самогерметизирующимся патрубком, хромированный.

Cod./Code	Mis./Size	□/⊞	€
156105015	1/2"	1/18	35,71

## IVR 553 CHR



THERMOCHROME, detentore a squadra, fornita con adattatore per attacco tubo ferro, bocchettone, cromato

THERMOCHROME, chrome-plated angle lockshield, iron pipe connection, autoseal tail piece

THERMOCHROME, Eckrücklaufverschraubung mit Anschluss für Eisenrohr, mit Selbstdichtung, verchromt

THERMOCHROME, coude de réglage équerre, fixation tube en fer, raccord avec auto-étanche, chromé

THERMOCHROME, угловой отсекающий клапан, соединение для стальной трубы, с самогерметизирующимся патрубком, хромированный.

Cod./Code	Mis./Size	□/⊞	€
155305015	1/2"	1/18	29,89

## IVR 773 CHR



KIT TERMOARREDO composto da valvola termostattabile e detentore, cromati. Dritto, fornita con adattatore per attacco tubo ferro

THERMOCHROME KIT for design radiator with thermostatic valve and lockshield, chrome-plated. Straight, iron pipe connection

DESIGNGARNITUR: Regulierventil (für Thermostat) und Rücklaufverschraubung, verchromt. Gerade Verschraubung, Anschluss für Eisenrohr

KIT pour radiateurs design composé de vanne thermostatisable et coude de réglage chromés. Droit, fixation tube fer

Комплект для дизайнерских радиаторов, состоящий из термостатического и отсекающего клапанов, хромированный. Прямой вентиль, соединение для стальной трубы

Cod./Code	Mis./Size	□/⊞	€
177305005	1/2"	1/15	69,90



## IVR 560 CHR



THERMOCHROME, valvola termostattabile diritta, fornita con adattatore per attacco tubo ferro, bocchettone autotenuta, cromata

THERMOCHROME, chrome-plated straight thermostatic valve, iron pipe connection, autoseal tail piece

THERMOCHROME, Gerade Rücklaufverschraubung mit Anschluss für Eisenrohr, mit Selbstdichtung, verchromt

THERMOCHROME, vanne thermostatisable droite, fournie avec adaptateurs pour fixation tube en fer, raccord avec auto-étanche, chromée

THERMOCHROME, термостатический прямой клапан, соединение для стальной трубы, с самогерметизирующимся патрубком, хромированный.

Cod./Code	Mis./Size	□/⊞	€
156005015	1/2"	1/18	37,69

## IVR 551 CHR



THERMOCHROME, detentore diritto, fornita con adattatore per attacco tubo ferro, bocchettone autotenuta, cromato

THERMOCHROME, chrome-plated straight lockshield, iron pipe connection, autoseal tail piece

THERMOCHROME, Gerade Rücklaufverschraubung mit Anschluss für Eisenrohr, mit Selbstdichtung, verchromt

THERMOCHROME, coude de réglage droit, fourni avec adaptateurs pour fixation tube en fer, raccord avec auto-étanche, chromé

THERMOCHROME, прямой отсекающий клапан, соединение для стальной трубы, с самогерметизирующимся патрубком, хромированный.

Cod./Code	Mis./Size	□/⊞	€
155105015	1/2"	1/18	31,38

## IVR 580 CHR



Adattatori per tubo rame - Cromati

THERMOCHROME Adapters for copper pipe - Chrome

Zwischenstücke / Adapter für Kupferrohr - verchromt

Adaptateurs pour tubes en cuivre - Chromé

Адаптеры для медной трубы - хромированные

Cod./Code	Mis./Size	Att./Conn.	□/⊞	€
158024710	10	24-19	10/180	6,88
158024720	12	24-19	10/180	6,88
158024740	14	24-19	10/180	6,88
158024750	15	24-19	10/180	6,88
158024760	16	24-19	10/180	6,88

## IVR 581 CHR



Adattatori universali a compressione per tubi multistrato e polietilene reticolato PEX, nichelati - Cromati.

THERMOCHROME Adapters for multilayer pipe and cross-linked polyethylene pipe PEX, nickel plated - chrome-plated

Universal-Zwischenstücke/Adapter zur Kompression für Mehrschichtrohren und Rohren aus vernetztem Polyethylen PEX - vernickelt - verchromt

Adaptateurs universels à compression pour tubes multicouche et polyéthylène réticulé PEX - nickelés - Chromé.

Универсальные компрессионные адаптеры для многослойных и полиэтиленовых труб PEX, никелированные – Хромированные

Cod./Code	Mis./Size	Att./Conn.	□/⊞	€
158124743	14 x 2	24-19	10/180	6,56
158124763	16 x 2	24-19	10/180	6,00
158124764	16 x 2,2	24-19	10/180	6,56





## TESTE TERMOSTATICHE THERMOSTATIC HEADS

### IVR 597



Testa termostatica con sensore a liquido - a bassa inerzia termica - Bianca  
Thermostatic head with liquid sensor - low thermal inertia - White  
Thermostatkopf mit Flüssigkeitssensor - geringe thermische Trägheit - Verchromt - Weiß  
Tête thermostatique avec capteur à liquide - à faible inertie thermique - Blanc  
Термостатическая головка с жидкостным сенсором - с низкой термоинерцией - Белая

Cod./Code	Series	Att./Conn.	□/⊕	€
159700001	Bianca/White	M30 x 1,5	1/50	14,95



### IVR 599



Testa termostatica con sensore a liquido - a bassa inerzia termica - Con sensore a distanza  
Thermostatic head with liquid sensor - low thermal inertia - With remote sensor  
Thermostatkopf mit Flüssigkeitssensor - geringe thermische Trägheit. Mit Fernsensor  
Tête thermostatique avec capteur à liquide - à faible inertie thermique - Avec capteur à distance  
Термостатическая головка с жидкостным сенсором - с низкой термоинерцией - С дистанционным датчиком

Cod./Code	Att./Conn.	□/⊕	€
159900001	M30 x 1,5	1/15	26,53



### IVR 591



Testa termostatica con sensore a liquido e sonda ad immersione  
Thermostatic head with liquid sensor and sensor immersion sleeve  
Thermostatkopf mit Flüssigkeitssensor und Tauchsonde  
Tête thermostatique avec capteur à liquide et sonde à immersion  
Термостатическая головка с жидкостным сенсором и погружным датчиком

Cod./Code	Att./Conn.	□/⊕	€
159100001	M30 x 1,5	1/20	29,44



## VALVOLE TERMOSTATICHE - ATTACCO FERRO THERMOSTATIC VALVES - IRON CONNECTION

### IVR 561



Valvola termostaticabile a squadra con volantino manuale attacco tubo ferro, bocchettone con autotenuta, nichelata

Angle thermostatic valve with manual handle, iron pipe connection, tail piece with auto-seal, nickel plated

Thermostatventil eckförmig mit Handrad, Anschluss für Eisenrohr, mit Selbstdichtung, vernickelt

Vanne thermostatisable, équerre, avec volant manuel, fixation tube fer, raccord autoétanche, nickelée

Угловой термостатический клапан с ручным управлением, соединение для стальной трубы, с герметичной прокладкой, никелированный

Cod./Code	Mis./Size	□/田	€
156103000	3/8"	10/60	10,99
156105000	1/2"	10/40	12,30
156107000	3/4"	10/40	16,54



### IVR 561/2



Valvola termostaticabile a squadra con volantino manuale attacco tubo ferro, bocchettone senza autotenuta, nichelata

Angle thermostatic valve with manual handle, iron pipe connection and tail piece without auto-seal, nickel plated

Thermostatventil eckförmig mit Handrad, Anschluss für Eisenrohr, Verschraubung ohne Selbstdichtung, vernickelt

Vanne thermostatisable, équerre, avec volant manuel, fixation tube fer, raccord non autoétanche, nickelée

Угловой термостатический клапан, с ручным управлением, соединение для стальной трубы, без герметичной прокладки, никелированный

Cod./Code	Mis./Size	□/田	€
156103002	3/8"	10/60	10,59
156105002	1/2"	10/40	11,83
156107002	3/4"	10/40	15,29



### IVR 561/3



Valvola termostaticabile a squadra attacco tubo ferro, bocchettone con autotenuta, nichelata, con preregolazione e volantino manuale

Angle thermostatic valve with presetting and manual handle, iron pipe connection, tail piece with auto-seal, nickel plated

Thermostatventil eckförmig mit Voreinstellung und Handrad, mit Anschluss für Eisenrohr, Selbstdichtung, vernickelt

Vanne thermostatisable, équerre avec préréglage et volant manuel, fixation tube fer, raccord autoétanche, nickelée

Угловой термостатический клапан с преднастройкой и ручным управлением, соединение для стальной трубы, с герметичной прокладкой, никелированный

Cod./Code	Mis./Size	□/田	€
156103003	3/8"	10/60	11,53
156105003	1/2"	10/40	12,86
156107003	3/4"	10/40	17,16



### IVR 561/4



Valvola termostaticabile a squadra con volantino manuale, attacco tubo ferro, bocchettone senza autotenuta e preregolazione nichelata

Angle thermostatic valve with manual handle, iron pipe connection, tail piece without auto-seal, presetting, nickel plated

Thermostatventil eckförmig, mit Handrad, Anschluss für Eisenrohr, Verschraubung ohne Selbstdichtung und Voreinstellung

Vanne thermostatisable, équerre avec préréglage et volant manuel, fixation tube fer, raccord non autoétanche, nickelée

Угловой термостатический клапан для радиаторов с преднастройкой и ручным управлением, соединение для стальной трубы, без герметичной прокладки, никелированный

Cod./Code	Mis./Size	□/田	€
156103004	3/8"	10/60	11,19
156105004	1/2"	10/40	12,38
156107004	3/4"	10/40	15,95



## IVR 567



Valvola termostattabile a squadra attacco tubo ferro, bocchettone con autotenuta, nichelata, con cappello di regolazione

Angle thermostatic valve with operating cap, iron pipe connection, tail piece with auto-seal, nickel plated

Thermostatventil eckförmig mit Einstellkappe, mit Einstellkappe, Anschluss für Eisenrohr, Verschraubung mit Selbstdichtung, vernickelt

Vanne thermostatisable, équerre avec chapeau de réglage, fixation tube fer, raccord autoétanche, nickelée

Угловой термостатический клапан с регулирующим колпачком, соединение для стальной трубы, с герметичной прокладкой, никелированный

Cod./Code	Mis./Size	□/田	€
156703000	3/8"	10/120	10,67
156705000	1/2"	10/120	12,10
156707000	3/4"	10/60	15,26



## IVR 567/2



Valvola termostattabile a squadra attacco tubo ferro, bocchettone senza autotenuta, nichelata, con cappello di regolazione

Angle thermostatic valve with operating cap, iron pipe connection, with tail piece without auto-seal, nickel plated

Thermostatventil eckförmig mit Einstellkappe, Anschluss für Eisenrohr, Verschraubung mit Selbstdichtung, vernickelt

Vanne thermostatisable équerre avec chapeau de réglage, fixation tube fer, raccord non étanche - nickelée

Угловой термостатический клапан с регулирующим колпачком, соединение для стальной трубы, без герметичной прокладки, никелированный

Cod./Code	Mis./Size	□/田	€
156703002	3/8"	10/120	10,32
156705002	1/2"	10/120	11,57
156707002	3/4"	10/60	14,02



## IVR 567/3



Valvola termostattabile a squadra attacco tubo ferro, bocchettone con autotenuta, nichelata, con prerregolazione, con cappello di regolazione

Angle thermostatic valve with presetting and operating cap, iron pipe connection, with tail piece with auto-seal - nickel plated

Thermostatventil eckförmig mit Voreinstellung und Einstellkappe, Anschluss für Eisenrohr, Verschraubung mit Selbstdichtung, vernickelt

Vanne thermostatisable, équerre avec pré réglage et chapeau de réglage, fixation tube fer, raccord autoétanche, nickelée

Угловой термостатический клапан с преднастройкой и регулирующим колпачком, соединение для стальной трубы с герметичной прокладкой, никелированный

Cod./Code	Mis./Size	□/田	€
156703003	3/8"	10/120	11,29
156705003	1/2"	10/120	12,72
156707003	3/4"	10/60	15,89



## IVR 567/4



Valvola termostattabile a squadra attacco tubo ferro, bocchettone senza autotenuta, nichelata, con prerregolazione, con cappello di regolazione

Angle thermostatic valve with presetting and operating cap iron pipe connection, tail piece without auto-seal, nickel plated

Thermostatventil eckförmig, mit Voreinstellung und Einstellkappe, Anschluss für Eisenrohr, Verschraubung ohne Selbstdichtung, vernickelt

Vanne thermostatisable, équerre avec pré réglage et chapeau de réglage, fixation tube fer, raccord non autoétanche, nickelée

Угловой термостатический клапан с преднастройкой и регулирующим колпачком, соединение для стальной трубы без герметичной прокладки, никелированный

Cod./Code	Mis./Size	□/田	€
156703004	3/8"	10/120	10,93
156705004	1/2"	10/120	12,20
156707004	3/4"	10/60	14,66



## IVR 570



Valvola termostattabile reversa, attacco tubo ferro, nichelata, con cappello di regolazione e bocchettone con autotenuta

Axial angle thermostatic valve with operating cap, iron pipe connection, tail piece with auto-seal, nickel plated  
Thermostatischer Umsteuerungsventil eckförmig Anschluss für Eisenrohr und Einstellkappe, mit Einstellkappe, vernickelt

Vanne thermostatizable à corps inversé avec chapeau de réglage et raccord étanche, fixation tube fer, nickelée  
Реверсивный термостатический клапан с регулирующим колпачком, соединение для стальной трубы с герметичной прокладкой, никелированный

Cod./Code	Mis./Size	□/田	€
157005000	1/2"	10/60	13,35



## IVR 570/2



Valvola termostattabile reversa attacco tubo ferro, nichelata, con cappello di regolazione e bocchettone senza autotenuta

Axial angle thermostatic valve with iron pipe connection, with operating cap and tail piece without auto-seal, nickel plated

Thermostatischer Umsteuerungsventil eckförmig mit Anschluss für Eisenrohr und Einstellkappe und Verschraubung ohne Selbstdichtung, vernickelt

Vanne thermostatizable à corps inversé avec chapeau de réglage et raccord non étanche, fixation tube fer, nickelée

Реверсивный термостатический клапан с регулирующим колпачком, соединение для стальной трубы без герметичной прокладки, никелированный

Cod./Code	Mis./Size	□/田	€
157005002	1/2"	10/60	12,87



## IVR 570/3



Valvola termostattabile reversa attacco tubo ferro, nichelata, con preregolazione, con cappello di regolazione, bocchettone con autotenuta

Axial angle thermostatic valve with iron pipe connection, presetting, operating cap and tail piece with auto-seal, nickel plated

Thermostatischer Umsteuerungsventil eckförmig mit Anschluss für Eisenrohr, Einstellkappe und Verschraubung mit Selbstdichtung, vernickelt

Vanne thermostatizable à corps inversé avec chapeau de réglage et raccord étanche, fixation tube fer, nickelée

Реверсивный термостатический клапан с преднастройкой и регулирующим колпачком, соединение для стальной трубы с герметичной прокладкой, никелированный

Cod./Code	Mis./Size	□/田	€
157005003	1/2"	10/60	13,72



## IVR 570/4



Valvola termostattabile reversa attacco tubo ferro, nichelata, con preregolazione, cappello di regolazione, bocchettone senza autotenuta

Axial angle thermostatic valve with iron pipe connection, presetting, operating cap and tail piece without auto-seal

Thermostatischer Umsteuerungsventil eckförmig mit Voreinstellung, Einstellkappe, Anschluss für Eisenrohr und Verschraubung ohne Selbstdichtung, vernickelt

Vanne thermostatizable à corps inversé avec chapeau de réglage et raccord non étanche, fixation tube fer, nickelée

Реверсивный термостатический клапан с преднастройкой и регулирующим колпачком, соединение для стальной трубы, без герметичной прокладки, никелированный

Cod./Code	Mis./Size	□/田	€
157005004	1/2"	10/60	13,27



## IVR 560



Valvola termostaticabile dritta attacco tubo ferro, bocchettone con autotenuta, nichelata, con volantino manuale  
Straight thermostatic valve with manual handle, iron pipe connection, tail piece with auto-seal - nickel plated  
Thermostatventil gerade mit Handrad, Anschluss für Eisenrohr, Verschraubung mit Selbstdichtung, vernickelt  
Vanne thermostatizable droite, fixation tube fer, avec volant manuel, raccord autoétanche, nickelée  
Прямой термостатический клапан с ручным управлением, соединение для стальной трубы, с герметичной прокладкой, никелированный

Cod./Code	Mis./Size	□/田	€
156003000	3/8"	10/60	11,75
156005000	1/2"	10/40	13,60
156007000	3/4"	10/40	18,14



## IVR 560/2



Valvola termostaticabile dritta con volantino manuale attacco tubo ferro, bocchettone senza autotenuta, nichelata  
Straight thermostatic valve with manual handle, iron pipe connection, tail piece without auto-seal, nickel plated  
Thermostatventil gerade mit Handrad, mit Anschluss für Eisenrohr, Verschraubung ohne Selbstdichtung - vernickelt  
Vanne thermostatizable droite, fixation tube fer, avec volant manuel, raccord non autoétanche, nickelée  
Прямой термостатический клапан с ручным управлением, соединение для стальной трубы, без герметичной прокладки, никелированный

Cod./Code	Mis./Size	□/田	€
156003002	3/8"	10/60	11,41
156005002	1/2"	10/40	13,11
156007002	3/4"	10/40	16,90



## IVR 560/3



Valvola termostaticabile dritta con volantino manuale attacco tubo ferro, bocchettone con autotenuta, nichelata, con preregolazione  
Straight thermostatic valve with presetting and with manual handle, iron pipe connection, tail piece with auto-seal - nickel plated  
Thermostatventil gerade mit Handrad, Voreinstellung, Anschluss für Eisenrohr und Verschraubung mit Selbstdichtung, vernickelt  
Vanne thermostatizable droite, avec volant manuel, fixation tube fer, raccord autoétanche et pré réglage, nickelée  
Прямой термостатический клапан с преднастройкой и ручным управлением, соединение для стальной трубы, с герметичной прокладкой, никелированный

Cod./Code	Mis./Size	□/田	€
156003003	3/8"	10/60	12,33
156005003	1/2"	10/40	14,16
156007003	3/4"	10/40	18,76



## IVR 560/4



Valvola termostaticabile attacco tubo ferro, bocchettone senza autotenuta, nichelata, con preregolazione, dritta con volantino manuale  
Straight thermostatic valve with presetting and manual handle, iron pipe connection, tail piece without auto-seal tail piece - nickel plated  
Thermostatventil gerade mit Voreinstellung, Handrad, Anschluss für Eisenrohr und Verschraubung ohne Selbstdichtung, vernickelt  
Vanne thermostatizable droite avec pré réglage et volant manuel, fixation tube fer, raccord non étanche, nickelée  
Прямой термостатический клапан с преднастройкой и ручным управлением, соединение для стальной трубы, без герметичной прокладки, никелированный

Cod./Code	Mis./Size	□/田	€
156003004	3/8"	10/60	11,96
156005004	1/2"	10/40	13,69
156007004	3/4"	10/40	17,53





## IVR 566



Valvola termostattabile dritta attacco tubo ferro, bocchettone con autotenuta, nichelata, con cappello di regolazione

Straight thermostatic valve with operating cap, iron pipe connection, tail piece with auto-seal - nickel plated  
Thermostatventil gerade mit Voreinstellung, Einstellkappe, Anschluss für Eisenrohr und Verschraubung mit Selbstdichtung, vernickelt

Vanne thermostatisable droite avec chapeau de réglage et volant manuel, fixation tube fer, raccord étanche, nickelée

Прямой термостатический клапан с регулирующим колпачком, соединение для стальной трубы, с герметичной прокладкой, никелированный

Cod./Code	Mis./Size	□/田	€
156603000	3/8"	10/60	11,55
156605000	1/2"	10/60	13,51
156607000	3/4"	10/60	16,82



## IVR 566/2



Valvola termostattabile attacco tubo ferro, bocchettone senza autotenuta, nichelata, dritta con cappello di regolazione

Straight thermostatic valve with operating cap, iron pipe connection, tail piece without auto-seal, nickel plated  
Thermostatventil gerade mit Einstellkappe, Anschluss für Eisenrohr und Verschraubung ohne Selbstdichtung, vernickelt

Vanne thermostatisable droite, avec fixation tube fer, raccord non étanche, et chapeau de réglage, nickelée

Прямой термостатический клапан с регулирующим колпачком, соединение для стальной трубы, без герметичной прокладки, никелированный

Cod./Code	Mis./Size	□/田	€
156603002	3/8"	10/60	11,11
156605002	1/2"	10/60	12,97
156607002	3/4"	10/60	15,60



## IVR 566/3



Valvola termostattabile dritta attacco tubo ferro, bocchettone con autotenuta, nichelata, con preregolazione e cappello di regolazione

Straight thermostatic valve with presetting, operating cap, iron pipe connection, tail piece with auto-seal, nickel plated

Thermostatventil gerade mit Voreinstellung, Einstellkappe, Anschluss für Eisenrohr und Verschraubung mit Selbstdichtung, vernickelt

Vanne thermostatisable droite, avec fixation tube fer, raccord étanche, pré-réglage et chapeau de réglage, nickelée

Прямой термостатический клапан с преднастройкой и регулирующим колпачком, соединение для стальной трубы, с герметичной прокладкой, никелированный

Cod./Code	Mis./Size	□/田	€
156603003	3/8"	10/60	11,64
156605003	1/2"	10/60	14,14
156607003	3/4"	10/60	17,46



## IVR 566/4



Valvola termostattabile dritta attacco tubo ferro, bocchettone senza autotenuta, nichelata, con preregolazione e cappello di regolazione

Straight thermostatic valve with presetting, operating cap iron pipe connection and tail piece without auto-seal, nickel plated

Thermostatventil gerade mit Voreinstellung und Einstellkappe, Anschluss für Eisenrohr und Verschraubung ohne Selbstdichtung, vernickelt

Vanne thermostatisable droite, avec fixation tube fer, raccord non étanche, pré-réglage et chapeau de réglage, nickelée

Прямой термостатический клапан с преднастройкой и регулирующим колпачком, соединение для стальной трубы, без герметичной прокладки, никелированный

Cod./Code	Mis./Size	□/田	€
156603004	3/8"	10/60	11,22
156605004	1/2"	10/60	13,61
156607004	3/4"	10/60	16,21



## VALVOLE TERMOSTATICHE - ATTACCO PEX-RAME THERMOSTATIC VALVES - PEX-COPPER CONNECTION

### IVR 563



Valvola termostaticabile a squadra, attacco PEX, multistrato e tubo rame, bocchettone con autotenuta, nichelata, con volantino manuale

Angle thermostatic valve, with manual handle, PEX, multilayer and copper pipe connection, tail piece with auto-seal, nickel plated

Thermostatventil, eckförmig mit Handrad, Anschluss für PEX, Mehrschicht und Kupferrohr, Verschraubung mit Selbstdichtung, vernickelt

Vanne thermostatizables équerre, avec volant manuel, fixation pour tubes PEX, multicouche et en cuivre, raccord autoétanche, nickelée

Угловой терmostатический клапан с ручным управлением, соединение для труб: медной, PEX и многослойной, патрубок с герметичной прокладкой, никелированный

Cod./Code	Mis./Size	Att./Conn.	□/⊕	€
156303160	3/8"	1/2"	10/60	12,39
156303180	3/8"	24-19	10/60	12,39
156305160	1/2"	1/2"	10/40	13,16
156305180	1/2"	24-19	10/40	13,27



### IVR 563/2



Valvola termostaticabile a squadra, attacco PEX, multistrato e tubo rame, bocchettone senza autotenuta, nichelata, con volantino manuale

Angle thermostatic valve with manual handle, PEX, multilayer and copper pipe connection, tail piece without auto-seal, nickel plated

Thermostatventil, eckförmig mit Handrad, Anschluss für PEX, Mehrschicht und Kupferrohr, Verschraubung ohne Selbstdichtung, vernickelt

Vannes thermostatizables équerre, avec volant manuel, fixation pour tubes PEX, multicouche et en cuivre, raccord non autoétanche, nickelée

Угловой терmostатический клапан с ручным управлением, соединение для труб: медной, PEX и многослойной, патрубок без герметичной прокладки, никелированный

Cod./Code	Mis./Size	Att./Conn.	□/⊕	€
156303162	3/8"	1/2"	10/60	11,99
156303182	3/8"	24-19	10/60	11,99
156305162	1/2"	1/2"	10/40	12,60
156305182	1/2"	24-19	10/40	12,67



### IVR 563/3



Valvola termostaticabile a squadra, attacco PEX, multistrato e tubo rame, bocchettone con autotenuta, nichelata, con prerogolazione e volantino manuale

Angle thermostatic valve with presetting and manual handle, PEX, multilayer and copper pipe connection, tail piece with auto-seal, nickel plated

Thermostatventil, eckförmig mit Voreinstellung und Handrad, Anschluss für PEX, Mehrschicht und Kupferrohr, Verschraubung mit Selbstdichtung, vernickelt

Vanne thermostatizables équerre, avec volant manuel, fixation pour tubes PEX, multicouche et en cuivre, raccord autoétanche, prérégulation, nickelée

Угловой терmostатический клапан для радиаторов с преднастройкой и ручным управлением, соединение для труб: медной, PEX и многослойной, патрубок с герметичной прокладкой, никелированный

Cod./Code	Mis./Size	Att./Conn.	□/⊕	€
156303163	3/8"	1/2"	10/60	12,63
156303183	3/8"	24-19	10/60	12,63
156305163	1/2"	1/2"	10/40	13,75
156305183	1/2"	24-19	10/40	13,75



### IVR 563/4



Valvola termostaticabile a squadra, attacco PEX, multistrato e tubo rame, bocchettone senza autotenuta, nichelata, con prerogolazione e volantino manuale

Angle thermostatic valve with presetting and manual handle, PEX, multilayer and copper pipe connection, tail piece without auto-seal, nickel plated

Thermostatventil, eckförmig mit Voreinstellung und Handrad, Anschluss für PEX, Mehrschicht und Kupferrohr und Verschraubung ohne Selbstdichtung, vernickelt

Vannes thermostatizables équerre, avec volant manuel, fixation pour tubes PEX, multicouche et en cuivre, raccord non autoétanche, prérégulation, nickelée

Угловой терmostатический клапан для радиаторов с преднастройкой и ручным управлением, соединение для труб: медной, PEX и многослойной, патрубок без герметичной прокладки, никелированный

Cod./Code	Mis./Size	Att./Conn.	□/⊕	€
156303164	3/8"	1/2"	10/60	12,21
156303184	3/8"	24-19	10/60	12,21
156305164	1/2"	1/2"	10/40	13,22
156305184	1/2"	24-19	10/40	13,22



## IVR 569



Valvola termostaticabile a squadra, attacco PEX, multistrato e tubo rame, bocchettone con autotenuta, nichelata, con cappello di regolazione

Angle thermostatic valve with operating cap, PEX, multilayer and copper pipe connection, tail piece with auto-seal, nickel plated

Thermostatventil, eckförmig mit Einstellkappe, Anschluss für PEX, Mehrschicht und Kupferrohr und Verschraubung mit Selbstdichtung, vernickelt

Vanne thermostatisable équerre avec chapeau de réglage, fixation pour tubes PEX, multicouche et en cuivre, raccord autoétanche, nickelée

Угловой термостатический клапан с регулирующим колпачком, соединение для труб: медной, PEX и многослойной, патрубок с герметичной прокладкой, никелированный

Cod./Code	Mis./Size	Att./Conn.	□/⊕	€
156903160	3/8"	1/2"	10/120	11,08
156903180	3/8"	24-19	10/120	11,08
156905160	1/2"	1/2"	10/120	11,97
156905180	1/2"	24-19	10/120	11,97



## IVR 569/2



Valvola termostaticabile a squadra, attacco PEX, multistrato e tubo rame, bocchettone senza autotenuta, nichelata, con cappello di regolazione

Angle thermostatic valve with operating cap, PEX, multilayer and copper pipe connection, tail piece without auto-seal, nickel plated

Thermostatventil, eckförmig mit Einstellkappe, mit Anschluss für PEX, Mehrschicht und Kupferrohr, Verschraubung ohne Selbstdichtung, vernickelt

Vanne thermostatisable équerre avec chapeau de réglage, fixation pour tubes PEX, multicouche et en cuivre, raccord autoétanche, nickelée

Угловой термостатический клапан с регулирующим колпачком, соединение для труб: медной, PEX и многослойной, патрубок без герметичной прокладки, никелированный

Cod./Code	Mis./Size	Att./Conn.	□/⊕	€
156903162	3/8"	1/2"	10/120	10,68
156903182	3/8"	24-19	10/120	10,68
156905162	1/2"	1/2"	10/120	11,37
156905182	1/2"	24-19	10/120	11,67



## IVR 569/3



Valvola termostaticabile a squadra, attacco PEX, multistrato e tubo rame, bocchettone con autotenuta, nichelata, con prerregolazione e cappello di regolazione

Angle thermostatic valve with presetting and operating cap, PEX, multilayer and copper pipe connection, tail piece with auto-seal, nickel plated

Thermostatventil, eckförmig mit Einstellkappe, Anschluss für PEX, Mehrschicht und Kupferrohr und Verschraubung mit Selbstdichtung, vernickelt

Vanne thermostatisable équerre avec chapeau de réglage, fixation pour tubes PEX, multicouche et en cuivre, raccord autoétanche, prérégulation, nickelée

Угловой термостатический клапан с преднастройкой и регулирующим колпачком, соединение для труб: медной, PEX и многослойной, патрубок с герметичной прокладкой, никелированный

Cod./Code	Mis./Size	Att./Conn.	□/⊕	€
156903163	3/8"	1/2"	10/120	11,32
156903183	3/8"	24-19	10/120	11,32
156905163	1/2"	1/2"	10/120	12,49
156905183	1/2"	24-19	10/120	12,49



## IVR 569/4



Valvola termostaticabile a squadra, attacco PEX, multistrato e tubo rame, bocchettone senza autotenuta, nichelata, con prerregolazione e cappello di regolazione

Angle thermostatic valve with presetting and operating cap, PEX, multilayer and copper pipe connection, tail piece without auto-seal, nickel plated

Thermostatventil, eckförmig, mit Voreinstellung und Einstellkappe, Anschluss für PEX, Mehrschicht und Kupferrohr und Verschraubung ohne Selbstdichtung, vernickelt

Vanne thermostatisable équerre avec chapeau de réglage, fixation pour tubes PEX, multicouche et en cuivre, raccord non autoétanche, prérégulation, nickelée

Угловой термостатический клапан с преднастройкой и регулирующим колпачком, соединение для труб: медной, PEX и многослойной, патрубок без герметичной прокладки, никелированный

Cod./Code	Mis./Size	Att./Conn.	□/⊕	€
156903164	3/8"	1/2"	10/120	10,91
156903184	3/8"	24-19	10/120	10,91
156905164	1/2"	1/2"	10/120	11,97
156905184	1/2"	24-19	10/120	11,97



## IVR 571



Valvola termostattabile reversa con cappello di regolazione, attacco PEX, multistrato e tubo rame, bocchettone con autotenuta, nichelata.

Axial angle valve with operating cap, PEX, multilayer and copper pipe connection, tail piece with auto-seal, nickel plated

Thermostatventil, eckförmig, mit Einstellkappe, Anschluss für PEX, Mehrschicht und Kupferrohr, Verschraubung mit Selbstdichtung, vernickelt

Vanne thermostatisable à corps inversé avec chapeau de réglage, fixation pour tubes PEX, multicouche et en cuivre, raccord autoétanche, nickelée

Реверсивный термостатический клапан с регулирующим колпачком, соединение для труб: медной, PEX и многослойной, патрубок с герметичной прокладкой, никелированный

Cod./Code	Mis./Size	Att./Conn.	□/⊕	€
157105180	1/2"	24-19	10/60	13,35



## IVR 571/2



Valvola termostattabile reversa con cappello di regolazione, attacco PEX, multistrato e tubo rame, bocchettone senza autotenuta, nichelata.

Axial angle thermostatic valve with operating cap, PEX, multilayer and copper pipe connection, tail piece without auto-seal, nickel plated

Eckförmiges Umsteuerungsventil mit Einstellkappe, Anschluss für PEX, Mehrschicht und Kupferrohr, Verschraubung ohne Selbstdichtung, vernickelt

Vanne thermostatisable à corps inversé avec chapeau de réglage, fixation pour tubes PEX, multicouche et en cuivre, raccord non autoétanche, nickelée

Реверсивный термостатический клапан с регулирующим колпачком, соединение для труб: медной, PEX и многослойной, патрубок без герметичной прокладки, никелированный

Cod./Code	Mis./Size	Att./Conn.	□/⊕	€
157105182	1/2"	24-19	10/60	12,87



## IVR 571/3



Valvola termostattabile reversa con preregolazione, con cappello di regolazione, attacco PEX, multistrato e tubo rame, bocchettone con autotenuta, nichelata.

Axial angle thermostatic valve with presetting and operating cap, PEX, multilayer and copper pipe connection, tail piece with auto-seal, nickel plated

Eckförmiges Umsteuerungsventil mit Einstellkappe, Anschluss für PEX, Mehrschicht und Kupferrohr, Verschraubung mit Selbstdichtung, vernickelt

Vanne thermostatisable à corps inversé avec chapeau de réglage, fixation pour tubes PEX, multicouche et en cuivre, raccord non autoétanche, nickelée

Реверсивный термостатический клапан с преднастройкой и регулирующим колпачком, соединение для труб: медной, PEX и многослойной, патрубок с герметичной прокладкой, никелированный

Cod./Code	Mis./Size	Att./Conn.	□/⊕	€
157105183	1/2"	24-19	10/60	13,72



## IVR 571/4



Valvola termostattabile reversa con preregolazione, con cappello di regolazione, attacco PEX, multistrato e tubo rame, bocchettone senza autotenuta, nichelata.

Axial angle thermostatic valve with presetting and operating cap, PEX, multilayer and copper pipe connection, tail piece without auto-seal, nickel plated

Eckförmiges Umsteuerungsventil mit Voreinstellung und Einstellkappe, Anschluss für PEX, Mehrschicht und Kupferrohr, Verschraubung ohne Selbstdichtung, vernickelt

Vanne thermostatisable à corps inversé avec chapeau de réglage, fixation pour tubes PEX, multicouche et en cuivre, raccord non autoétanche, nickelée

Реверсивный термостатический клапан с преднастройкой и регулирующим колпачком, соединение для труб: медной, PEX и многослойной, патрубок без герметичной прокладки, никелированный

Cod./Code	Mis./Size	Att./Conn.	□/⊕	€
157105184	1/2"	24-19	10/60	13,27



## IVR 562



Valvola termostattizzabile dritta, attacco PEX, multistrato e tubo rame, bocchettone con autotenuta, nichelata, con volantino manuale

Straight thermostatic valve with manual handle, PEX, multilayer and copper pipe connection, tail piece with auto-seal, nickel plated

Thermostatventil, gerade, mit Handrad, Anschluss für PEX, Mehrschicht und Kupferrohr und Verschraubung mit Selbstdichtung, vernickelt

Vanne thermostatisable droite avec volant manuel, fixation pour tubes PEX, multicouche et en cuivre, raccord autoétanche, nickelée

Прямой термостатический клапан с ручным управлением, соединение для труб: медной, PEX и многослойной, патрубок с герметичной прокладкой, никелированный

Cod./Code	Mis./Size	Att./Conn.	□/田	€
156203160	3/8"	1/2"	10/60	12,19
156203180	3/8"	24-19	10/60	12,45
156205160	1/2"	1/2"	10/40	13,15
156205180	1/2"	24-19	10/40	13,10



## IVR 562/2



Valvola termostattizzabile dritta, attacco PEX, multistrato e tubo rame, bocchettone senza autotenuta, nichelata, con volantino manuale

Straight thermostatic valve with manual handle, PEX, multilayer and copper pipe connection, tail piece without auto-seal, nickel plated

Thermostatventil, gerade, mit Handrad, Anschluss für PEX, Mehrschicht und Kupferrohr und Verschraubung ohne Selbstdichtung, vernickelt

Vanne thermostatisable droite avec volant manuel, fixation pour tubes PEX, multicouche et en cuivre, raccord non autoétanche, nickelée

Прямой термостатический клапан с ручным управлением, соединение для труб: медной, PEX и многослойной, патрубок без герметичной прокладки, никелированный

Cod./Code	Mis./Size	Att./Conn.	□/田	€
156203162	3/8"	1/2"	10/60	11,84
156203182	3/8"	24-19	10/60	12,09
156205162	1/2"	1/2"	10/40	12,04
156205182	1/2"	24-19	10/40	12,62



## IVR 562/3



Valvola termostattizzabile dritta, attacco PEX, multistrato e tubo rame, bocchettone con autotenuta, nichelata, con prerogolazione e volantino manuale

Straight thermostatic valve with presetting and with manual handle, PEX, multilayer and copper pipe connection, tail piece with auto-seal, nickel plated

Thermostatventil, gerade, mit Voreinstellung und Handrad, Anschluss für PEX, Mehrschicht und Kupferrohr, Verschraubung mit Selbstdichtung, vernickelt

Vanne thermostatisable droite avec volant manuel, fixation pour tubes PEX, multicouche et en cuivre, raccord autoétanche et pré réglage, nickelée

Прямой термостатический клапан с преднастройкой и ручным управлением, соединение для труб: медной, PEX и многослойной, патрубок с герметичной прокладкой, никелированный

Cod./Code	Mis./Size	Att./Conn.	□/田	€
156203163	3/8"	1/2"	10/60	12,75
156203183	3/8"	24-19	10/60	13,03
156205163	1/2"	1/2"	10/40	13,73
156205183	1/2"	24-19	10/40	13,66



## IVR 562/4



Valvola termostattizzabile dritta, attacco PEX, multistrato e tubo rame, bocchettone senza autotenuta, nichelata, con prerogolazione e volantino manuale

Straight thermostatic valve with presetting and manual handle, PEX, multilayer and copper pipe connection, tail piece without auto-seal, nickel plated

Thermostatventil, gerade, mit Voreinstellung und Handrad, Anschluss für PEX, Mehrschicht und Kupferrohr und Verschraubung ohne Selbstdichtung, vernickelt

Vanne thermostatisable droite avec volant manuel, fixation pour tubes PEX, multicouche et en cuivre, raccord non autoétanche et pré réglage, nickelée

Прямой термостатический клапан с преднастройкой и ручным управлением, соединение для труб: медной, PEX и многослойной, патрубок без герметичной прокладки, никелированный

Cod./Code	Mis./Size	Att./Conn.	□/田	€
156203164	3/8"	1/2"	10/60	12,39
156203184	3/8"	24-19	10/60	12,67
156205164	1/2"	1/2"	10/40	13,27
156205184	1/2"	24-19	10/40	13,19





## IVR 568



Valvola termostaticizzabile dritta, attacco PEX, multistrato e tubo rame, bocchettone con autotenuta, nichelata, con cappello di regolazione

Straight thermostatic valve with operating cap, PEX, multilayer and copper pipe connection, tail piece with auto-seal, nickel plated

Thermostatventil, gerade, mit Einstellkappe, Anschluss für PEX, Mehrschicht und Kupferrohr und Verschraubung mit Selbstdichtung, vernickelt

Vanne thermostatisable droite avec volant manuel, fixation pour tubes PEX, multicouche et en cuivre, raccord autoétanche et chapeau de réglage, nickelée

Прямой термостатический клапан с регулирующим колпачком, соединение для труб: медной, PEX и многослойной, патрубок с герметичной прокладкой, никелированный

Cod./Code	Mis./Size	Att./Conn.	□/田	€
156803160	3/8"	1/2"	10/60	11,05
156803180	3/8"	24-19	10/60	11,33
156805160	1/2"	1/2"	10/60	12,04
156805180	1/2"	24-19	10/60	11,97



## IVR 568/2



Valvola termostaticizzabile dritta, attacco PEX, multistrato e tubo rame, bocchettone senza autotenuta, nichelata, con cappello di regolazione

Straight thermostatic valve with operating cap, PEX, multilayer and copper pipe connection, tail piece without auto-seal, nickel plated

Thermostatventil, gerade, mit Einstellkappe, Anschluss für PEX, Mehrschicht und Kupferrohr und Verschraubung ohne Selbstdichtung, vernickelt

Vanne thermostatisable droite avec volant manuel, fixation pour tubes PEX, multicouche et en cuivre, raccord non autoétanche et chapeau de réglage, nickelée

Прямой термостатический клапан с регулирующим колпачком, соединение для труб: медной, PEX и многослойной, патрубок без герметичной прокладки, никелированный

Cod./Code	Mis./Size	Att./Conn.	□/田	€
156803162	3/8"	1/2"	10/60	10,69
156803182	3/8"	24-19	10/60	10,98
156805162	1/2"	1/2"	10/60	11,56
156805182	1/2"	24-19	10/60	11,48



## IVR 568/3



Valvola termostaticizzabile dritta, attacco PEX, multistrato e tubo rame, bocchettone con autotenuta, nichelata, con prerregolazione e cappello di regolazione

Straight thermostatic valve with presetting and operating cap, PEX, multilayer and copper pipe connection, tail piece with auto-seal, nickel plated

Thermostatventil, gerade, mit Voreinstellung und Einstellkappe, Anschluss für PEX, Mehrschicht und Kupferrohr und Verschraubung mit Selbstdichtung, vernickelt

Vanne thermostatisable droite avec chapeau de réglage, fixation pour tubes PEX, multicouche et en cuivre, raccord autoétanche, pré-réglage, nickelée

Прямой термостатический клапан с преднастройкой и регулирующим колпачком, соединение для труб: медной, PEX и многослойной, патрубок с герметичной прокладкой, никелированный

Cod./Code	Mis./Size	Att./Conn.	□/田	€
156803163	3/8"	1/2"	10/60	11,62
156803183	3/8"	24-19	10/60	11,88
156805163	1/2"	1/2"	10/60	12,60
156805183	1/2"	24-19	10/60	12,54



## IVR 568/4



Valvola termostaticizzabile dritta, attacco PEX, multistrato e tubo rame, bocchettone senza autotenuta, nichelata, con prerregolazione e con cappello di regolazione

Straight thermostatic valve with presetting and operating cap, PEX, multilayer and copper pipe connection, tail piece without auto-seal, nickel plated

Thermostatventil, gerade, mit Voreinstellung und Einstellkappe, Anschluss für PEX, Mehrschicht und Kupferrohr, Verschraubung ohne Selbstdichtung, vernickelt

Vanne thermostatisable droite avec chapeau de réglage, fixation pour tubes PEX, multicouche et en cuivre, raccord non autoétanche, pré-réglage, nickelée

Прямой термостатический клапан с преднастройкой и регулирующим колпачком, соединение для труб: медной, PEX и многослойной, патрубок с герметичной прокладкой, никелированный

Cod./Code	Mis./Size	Att./Conn.	□/田	€
156803164	3/8"	1/2"	10/60	11,26
156803184	3/8"	24-19	10/60	11,53
156805164	1/2"	1/2"	10/60	12,12
156805184	1/2"	24-19	10/60	12,06



## VALVOLE TERMOSTATICHE COASSIALI THERMOSTATIC COAXIAL VALVES

### IVR 530



Valvola coassiale termostattizzabile a 3 vie per radiatori con cappellino di regolazione. Attacchi tubo ferro. Bocchettone con autotenuta, adatto per utilizzo su ogni tipo di radiatore

Thermostatic coaxial 3-way radiator valve with operating cap. Iron pipe connection. Tail piece with auto-seal, suitable for any type of radiator

3-Wege Koaxial-Thermostatventil für Heizkörper mit Einstellkappe. Anschluss für Eisenrohr. Verschraubung mit Selbstdichtung. Sie können auf jede Sorte von Heizkörper eingesetzt werden

Vanne coassiale termostatisabile à 3 voies pour radiateurs avec chapeau de réglage. Fixation tube fer. Raccord auto-étanche. Usage: adapté à tout type de radiateur

3-х ходовой коаксиальный термостатический радиаторный клапан с регулирующим пластиковым колпачком. Соединение для стальной трубы. Самоуплотняющийся патрубок, может применяться с любым типом радиаторов

Cod./Code	Mis./Size	□/⊞	€
153003000	3/8"	10/60	13,86
153005000	1/2"	10/40	16,56



### IVR 530 AD



Adattatore per tubo PEX/Rame/PEX-AL-PEX

Adapter for PEX, multilayer and copper pipe

PEX, Kupferrohr und Mehrschichtrohr Anschlussadapter

Adaptateur pour tube PEX, multi-couches ou cuivre.

Адаптер для труб: металлопластиковой, медной и PEX

Cod./Code	Mis./Size	Att./Conn.	□/⊞	€
153003024	3/8"	24-19	10/150	3,10
153005024	1/2"	24-19	10/150	3,10



## DETENTORI - ATTACCO FERRO LOCKSHIELDS - IRON CONNECTION

### IVR 553



Detentore a squadra per valvole Saturn, attacco tubo ferro, bocchettone con autotenuta, nichelato

Angle heavy pattern lockshield for Saturn TR valves, iron pipe connection, tail piece with auto-seal, nickel plated

Rücklaufverschraubung eckförmig für Saturn - Ventile, Anschluss für Eisenrohr, Verschraubung mit Selbstdichtung, vernickelt

Coude de réglage équerre pour vanne Saturn, fixation tube fer, raccord autoétanche, nickelée

Угловой отсекающий клапан для серии Saturn, соединение для стальной трубы, патрубков с герметичной прокладкой, никелированный

Cod./Code	Mis./Size	□/田	€
155303000	3/8"	10/120	7,77
155305000	1/2"	10/120	9,48
155307000	3/4"	10/60	14,44



### IVR 553/2



Detentore a squadra per valvole Saturn, attacco tubo ferro, bocchettone senza autotenuta, nichelato

Angle heavy pattern lockshield for Saturn TR valves, iron pipe connection, tail piece without auto-seal, nickel plated

Rücklaufverschraubung eckförmig für Saturn - Ventile, Anschluss für Eisenrohr, Verschraubung ohne Selbstdichtung, vernickelt

Coude de réglage équerre pour vanne Saturn, fixation tube fer, raccord non étanche, nickelée

Угловой отсекающий клапан для серии Saturn, соединение для стальной трубы, патрубков без герметичной прокладки, никелированный

Cod./Code	Mis./Size	□/田	€
155303002	3/8"	10/120	7,38
155305002	1/2"	10/120	9,01
155307002	3/4"	10/60	13,10



### IVR 551



Detentore dritto per valvole Saturn, attacco tubo ferro, bocchettone con autotenuta, nichelato

Straight heavy lockshield for TR Saturn valves, iron pipe connection, tail piece with auto-seal, nickel plated

Rücklaufverschraubung gerade für Saturn - Ventile, Anschluss für Eisenrohr, Verschraubung mit Selbstdichtung, vernickelt

Coude de réglage droite pour vanne Saturn, fixation tube fer, raccord étanche, nickelée

Прямой отсекающий клапан для серии Saturn, соединение для стальной трубы, патрубков с герметичной прокладкой, никелированный

Cod./Code	Mis./Size	□/田	€
155103000	3/8"	10/120	8,15
155105000	1/2"	10/120	11,11
155107000	3/4"	10/60	16,14



### IVR 551/2



Detentore dritto per valvole Saturn, attacco tubo ferro, bocchettone senza autotenuta, nichelato

Straight heavy pattern lockshield for TR Saturn valves, iron pipe connection, tail piece without auto-seal, nickel plated

Rücklaufverschraubung gerade für Saturn - Ventile, Anschluss für Eisenrohr, Verschraubung ohne Selbstdichtung, vernickelt

Coude de réglage droite pour vanne Saturn, fixation tube fer, raccord non étanche, nickelée

Прямой отсекающий клапан для серии Saturn, соединение для стальной трубы, патрубков без герметичной прокладки, никелированный

Cod./Code	Mis./Size	□/田	€
155103002	3/8"	10/120	7,41
155105002	1/2"	10/120	10,64
155107002	3/4"	10/60	14,78



## DETENTORI - ATTACCO PEX-RAME LOCKSHIELDS - PEX-COPPER CONNECTION

### IVR 557



Detentore a squadra, attacco PEX, multistrato e tubo rame, bocchettone con autotenuta, nichelato

Angle heavy pattern lockshield, PEX, multilayer and copper pipe connection, tail piece with auto-seal, nickel plated

Rücklaufverschraubung eckförmig, mit Anschluss für PEX, Mehrschicht - und Kupferrohr, Verschraubung mit Selbstdichtung, vernickelt

Coude de réglage équerre, fixation PEX, multicouche et tube en cuivre, raccord autoétanche, nickelée

Угловой отсекающий клапан, соединения для трубы PEX, медной и многослойной труб, патрубков с уплотнением, никелированный

Cod./Code	Mis./Size	Att./Conn.	□/田	€
155703160	3/8"	1/2"	10/120	8,25
155703180	3/8"	24-19	10/120	8,25
155705160	1/2"	1/2"	10/120	9,75
155705180	1/2"	24-19	10/120	9,75



### IVR 557/2



Detentore a squadra, attacco PEX, multistrato e tubo rame, bocchettone senza autotenuta, nichelato

Angle heavy pattern lockshield, PEX, multilayer and copper pipe connection, tail piece without auto-seal, nickel plated

Rücklaufverschraubung eckförmig, mit Anschluss für PEX, Mehrschicht - und Kupferrohr, Verschraubung ohne Selbstdichtung, vernickelt

Coude de réglage équerre, fixation PEX, multicouche et tube en cuivre, raccord autoétanche, nickelée

Угловой отсекающий клапан, соединения для трубы PEX, медной и многослойной труб, патрубков без уплотнения, никелированный

Cod./Code	Mis./Size	Att./Conn.	□/田	€
155703162	3/8"	1/2"	10/120	7,75
155703182	3/8"	24-19	10/120	7,75
155705162	1/2"	1/2"	10/120	9,25
155705182	1/2"	24-19	10/120	9,25



### IVR 555



Detentore dritto, attacco PEX, multistrato e tubo rame, bocchettone con autotenuta, nichelato

Straight heavy pattern lockshield, PEX, multilayer and copper pipe connection, tail piece with auto-seal, nickel plated

Rücklaufverschraubung gerade, mit Anschluss für PEX, Mehrschicht - und Kupferrohr, Verschraubung mit Selbstdichtung, vernickelt

Coude de réglage, droit, fixation PEX, multicouche et tube en cuivre, raccord autoétanche, nickelée

Прямой отсекающий клапан, соединения для трубы PEX, медной и многослойной труб, патрубков с уплотнением, никелированный

Cod./Code	Mis./Size	Att./Conn.	□/田	€
155503160	3/8"	1/2"	10/120	8,62
155503180	3/8"	24-19	10/120	8,53
155505160	1/2"	1/2"	10/120	10,63



### IVR 555/2



Detentore dritto, attacco PEX, multistrato e tubo rame, bocchettone senza autotenuta, nichelato

Straight heavy pattern lockshield, PEX, multilayer and copper pipe connection, tail piece without auto-seal, nickel plated

Rücklaufverschraubung gerade, mit Anschluss für PEX, Mehrschicht - und Kupferrohr, Verschraubung ohne Selbstdichtung, vernickelt

Coude de réglage, droit, fixation PEX, multicouche et tube en cuivre, raccord non autoétanche, nickelée

Прямой отсекающий клапан, соединения для трубы PEX, медной и многослойной труб, патрубков без уплотнения, никелированный

Cod./Code	Mis./Size	Att./Conn.	□/田	€
155503162	3/8"	1/2"	10/120	8,28
155503182	3/8"	24-19	10/120	8,18
155505162	1/2"	1/2"	10/120	10,15



## KIT TERMOSTATICI THERMOSTATIC KITS

### IVR 567 KIT



Kit termostatico composto da valvola Saturn a squadra, detentore Mercury e testa termostatica a liquido Sunny, per attacco tubo ferro

Thermostatic kit: angle Saturn valve with iron pipe connection, Mercury lockshield and Sunny thermostatic head with liquid sensor

Gruppe bestehend aus eckförmigem Saturn-Thermostatventil mit Anschluss für Eisenrohr, Mercury-Rücklaufverschraubung und thermostatischem Kopf Sunny

Kit thermostatique composé de vanne Saturn équerre, coude de réglage Mercury et tête thermostatique avec capteur liquide Sunny, fixation tube fer

Термостатический комплект состоящий из углового клапана Saturn, отсекающего клапана Mercury и термостатической головки Sunny с жидкостным сенсором, соединения для стальной трубы

Cod./Code	Mis./Size	□/田	€
<b>1567K03000</b>	3/8"	1/15	28,38
<b>1567K05000</b>	1/2"	1/15	32,11
<b>1567K07000</b>	3/4"	1/15	40,04

### IVR 566 KIT



Kit termostatico composto da valvola Saturn dritto, detentore Mercury e testa termostatica a liquido Sunny, per attacco tubo ferro

Thermostatic kit: straight Saturn valve with iron pipe connection, Mercury lockshield and Sunny thermostatic head with liquid sensor

Gruppe bestehend aus geradem Saturn-Thermostatventil mit Anschluss für Eisenrohr, Mercury-Rücklaufverschraubung und thermostatischem Kopf Sunny

Kit thermostatique composé de vanne Saturn droite, coude de réglage Mercury et tête thermostatique avec capteur liquide Sunny, fixation tube fer

Термостатический комплект состоящий из прямого клапана Saturn, отсекающего клапана Mercury и термостатической головки Sunny с жидкостным сенсором, соединения для стальной трубы

Cod./Code	Mis./Size	□/田	€
<b>1566K03000</b>	3/8"	1/15	30,00
<b>1566K05000</b>	1/2"	1/15	35,13
<b>1566K07000</b>	3/4"	1/15	43,24

### IVR 569 KIT



Kit termostatico composto da valvola a squadra Saturn, detentore Mercury e testa termostatica a liquido Sunny, attacco tubo rame, PEX e multistrato

Thermostatic kit: angle Saturn valve with PEX, multilayer and copper pipe connection, Mercury lockshield and Sunny thermostatic head with liquid sensor

Gruppe bestehend aus eckförmigem Saturn-Thermostatventil mit Anschluss für PEX, Mehrschicht - und Kupferrohr, Mercury-Rücklaufverschraubung und thermostatischem Kopf Sunny

Kit thermostatique composé de vanne Saturn équerre, coude de réglage Mercury et tête thermostatique avec capteur liquide Sunny, fixation PEX, multicouche et tube en cuivre

Термостатический комплект состоящий из углового клапана Saturn, отсекающего клапана Mercury и термостатической головки Sunny с жидкостным сенсором, соединения для медной, PEX и многослойной труб

Cod./Code	Mis./Size	Att./Conn.	□/田	€
<b>1569K03160</b>	3/8"	1/2"	1/15	31,04
<b>1569K03180</b>	3/8"	24-19	1/15	29,38
<b>1569K05160</b>	1/2"	1/2"	1/15	31,78
<b>1569K05180</b>	1/2"	24-19	1/15	31,69



## IVR 568 KIT



Kit termostatico composto da valvola Saturn, detentore Mercury e testa termostatica a liquido Sunny, dritto, attacco tubo rame, PEX e multistrato

Thermostatic kit: straight Saturn valve with PEX, multilayer and copper pipe connection, Mercury lockshield and Sunny thermostatic head with liquid sensor

Gruppe bestehend aus geradem Saturn-Thermostatventil mit Anschluss für PEX, Mehrschicht - und Kupferrohr, Mercury-Rücklaufverschraubung und thermostatischem Kopf Sunny

Kit thermostatique composé de vanne Saturn droit, coude de réglage Mercury et tête thermostatique avec capteur liquide Sunny, fixation PEX, multicouche et tube en cuivre

Термостатический комплект состоящий из клапана Saturn, отсекающего клапана Mercury и термостатической головки Sunny с жидкостным сенсором, соединения для медной, PEX и многослойной труб

Cod./Code	Mis./Size	Att./Conn.	□/⊞	€
1568K03160	3/8"	1/2"	1/15	31,40
1568K03180	3/8"	24-19	1/15	31,58
1568K05160	1/2"	1/2"	1/15	34,39
1568K05180	1/2"	24-19	1/15	34,29

## IVR 570 KIT



Kit termostatico composto da valvola Saturn, detentore Mercury a squadra, per attacco tubo ferro e testa termostatica a liquido Sunny

Thermostatic kit: axial Saturn valve with iron pipe connection, Mercury lockshield and Sunny thermostatic head with liquid sensor

Gruppe bestehend aus eckförmigem Saturn-Thermostatventil mit Anschluss für Eisenrohr, Mercury-Rücklaufverschraubung und thermostatischem Kopf Sunny

Kit thermostatique composé de vanne Saturn équerre, coude de réglage Mercury et tête thermostatique avec capteur liquide Sunny, fixation tube en fer

Термостатический комплект состоящий из углового клапана Saturn, углового отсекающего клапана Mercury и термостатической головки Sunny с жидкостным сенсором, соединения для стальной трубы

Cod./Code	Mis./Size	□/⊞	€
1570K05000	1/2"	1/15	34,45

## IVR 571 KIT



Kit termostatico composto da valvola Saturn, detentore Mercury, a squadra, attacco tubo rame, PEX e multistrato e testa termostatica a liquido Sunny

Thermostatic kit: angle Saturn valve with PEX, multilayer and copper pipe connection, Mercury lockshield and Sunny thermostatic head with liquid sensor

Gruppe bestehend aus eckförmigem Saturn-Thermostatventil mit Anschluss für PEX, Mehrschicht - und Kupferrohr, Mercury-Rücklaufverschraubung und thermostatischem Kopf Sunny

Kit thermostatique composé de vanne Saturn, équerre, coude de réglage Mercury et tête thermostatique avec capteur liquide Sunny, fixation tube en cuivre, PEX et multicouche

Термостатический комплект состоящий из клапана Saturn, углового отсекающего клапана Mercury и термостатической головки Sunny с жидкостным сенсором, соединения для медной, PEX и многослойной труб

Cod./Code	Mis./Size	Att./Conn.	□/⊞	€
1571K05180	1/2"	24-19	1/15	34,17

## VALVOLE MANUALI - ATTACCO FERRO MANUAL VALVES - IRON CONNECTION

### IVR 536



Valvola manuale per radiatori, a squadra con volantino manuale, attacco tubo ferro, bocchettone con autotenuta, nichelata

Angle radiator valve with manual handle, iron pipe connection, tail piece with auto-seal, nickel plated

Heizkörperventil mit Handrad, eckförmig, mit Anschluss für Eisenrohr, Verschraubung mit Selbstdichtung, vernickelt

Robinet manuel pour radiateurs, équerre, avec volant manuel, fixation tube fer, raccord autoétanche, nickelée

Угловой клапан с ручным управлением для радиаторов, соединение для стальной трубы, патрубок с уплотнением, никелированный

Cod./Code	Mis./Size	□/田	€
153603000	3/8"	10/60	8,84
153605000	1/2"	10/60	9,90
153607000	3/4"	10/60	12,30



### IVR 536/2



Valvola per radiatori a squadra con volantino manuale, attacco tubo ferro, bocchettone senza autotenuta, nichelata

Angle radiator valve with manual handle, iron pipe connection, tail piece without auto-seal, nickel plated

Heizkörperventil mit Handrad, eckförmig, mit Anschluss für Eisenrohr, Verschraubung ohne Selbstdichtung, vernickelt

Robinet manuel pour radiateurs, équerre, avec volant manuel, fixation tube fer, raccord non autoétanche, nickelée

Угловой клапан с ручным управлением для радиаторов, соединение для стальной трубы, патрубок без уплотнения, никелированный

Cod./Code	Mis./Size	□/田	€
153603002	3/8"	10/60	8,48
153605002	1/2"	10/60	9,38
153607002	3/4"	10/60	11,07



### IVR 534



Valvola per radiatori, dritta con volantino manuale, attacco tubo ferro, bocchettone con autotenuta, nichelata

Straight radiator valve with manual handle, iron pipe connection, tail piece with auto-seal, nickel plated

Heizkörperventil mit Handrad, gerade, mit Anschluss für Eisenrohr, Verschraubung mit Selbstdichtung, vernickelt

Robinet manuel pour radiateurs, droit, avec volant manuel, fixation tube fer, raccord autoétanche, nickelée

Прямой клапан с ручным управлением для радиаторов, соединение для стальной трубы, патрубок с уплотнением, никелированный

Cod./Code	Mis./Size	□/田	€
153403000	3/8"	10/60	8,97
153405000	1/2"	10/60	10,60
153407000	3/4"	10/40	13,56



### IVR 534/2



Valvola per radiatori, dritta con volantino manuale, attacco tubo ferro, bocchettone senza autotenuta, nichelata

Straight radiator valve with manual handle, iron pipe connection, tail piece without auto-seal, nickel plated

Heizkörperventil mit Handrad, gerade, mit Anschluss für Eisenrohr, Verschraubung ohne Selbstdichtung, vernickelt

Robinet pour radiateurs, droit, avec volant manuel, fixation tube fer, raccord non autoétanche, nickelée

Прямой клапан с ручным управлением для радиаторов, соединение для стальной трубы, патрубок без уплотнения, никелированный

Cod./Code	Mis./Size	□/田	€
153403002	3/8"	10/60	8,56
153405002	1/2"	10/60	10,07
153407002	3/4"	10/40	12,34



## DETENTORI - ATTACCO FERRO LOCKSHIELD - IRON CONNECTION

### IVR 537



Detentore a squadra per radiatori, attacco tubo ferro, bocchettone con autotenuta, nichelato  
Angle lockshield for radiators, with iron pipe connection, tail piece with auto-seal, nickel plated  
Rücklaufverschraubung für Heizkörper, eckförmig, Anschluss für Eisenrohr, Verschraubung mit Selbstdichtung, vernickelt  
Coude de réglage pour radiateurs équerre, fixation tube fer, raccord autoétanche, nickelée  
Угловой отсекающий клапан для радиаторов, соединения для стальной трубы, патрубков с уплотнением, никелированный

Cod./Code	Mis./Size	□/田	€
153703000	3/8"	10/120	8,01
153705000	1/2"	10/120	8,60
153707000	3/4"	10/60	11,28



### IVR 537/2



Detentore a squadra per radiatori, attacco tubo ferro, bocchettone senza autotenuta, nichelato  
Angle lockshield, iron pipe connection, tail piece without auto-seal, nickel plated  
Rücklaufverschraubung für Heizkörper, eckförmig, Anschluss für Eisenrohr, Verschraubung ohne Selbstdichtung, vernickelt  
Coude de réglage, pour radiateurs équerre, fixation tube fer, raccord non autoétanche, nickelée  
Угловой отсекающий клапан для радиаторов, соединения для стальной трубы, патрубков без уплотнения, никелированный

Cod./Code	Mis./Size	□/田	€
153703002	3/8"	10/120	7,62
153705002	1/2"	10/120	8,07
153707002	3/4"	10/60	10,67



### IVR 535



Detentore dritto per radiatori, attacco tubo ferro, bocchettone con autotenuta, nichelato  
Straight lockshield for radiators, with iron pipe connection, tail piece with auto-seal, nickel plated  
Rücklaufverschraubung für Heizkörper, gerade, Anschluss für Eisenrohr, Verschraubung mit Selbstdichtung, vernickelt  
Coude de réglage pour radiateurs droit, fixation tube fer, raccord autoétanche, nickelée  
Прямой отсекающий клапан для радиаторов, соединения для стальной трубы, патрубков с уплотнением, никелированный

Cod./Code	Mis./Size	□/田	€
153503000	3/8"	10/120	7,80
153505000	1/2"	10/120	9,47
153507000	3/4"	10/60	12,45



### IVR 535/2



Detentore dritto per radiatori, attacco tubo ferro, bocchettone senza autotenuta, nichelato  
Straight lockshield, with iron pipe connection, tail piece without auto-seal, nickel plated  
Rücklaufverschraubung für Heizkörper, gerade, Anschluss für Eisenrohr, Verschraubung ohne Selbstdichtung, vernickelt  
Coude de réglage, pour radiateurs droit, fixation tube fer, raccord non autoétanche, nickelée  
Прямой отсекающий клапан для радиаторов, соединения для стальной трубы, патрубков без уплотнения, никелированный

Cod./Code	Mis./Size	□/田	€
153503002	3/8"	10/120	7,43
153505002	1/2"	10/120	8,94
153507002	3/4"	10/60	11,24



## IVR 549



Detentore a squadra NON ispezionabile per radiatori, attacco tubo ferro, bocchettone con autotenuta, nichelato  
Angle lockshield for radiators, with iron pipe connection, tail piece with auto-seal, nickel plated, brass cap  
Nicht inspizierbarer Winkelschloss für Heizkörper, Eisenrohranschluss, Verbindung mit selbstdichtend, vernickelt  
Vanne d'équerre NON inspectionnable pour radiateurs, raccord

Запорный клапан угловой НЕ проверяемый для радиаторов, соединение

Cod./Code	Mis./Size	□/田	€
154903000	3/8"	10/120	8,63
154905000	1/2"	10/120	8,15
154907000	3/4"	10/60	11,71



## IVR 549/2



Detentore NON ispezionabile per radiatori, a squadra, attacco tubo ferro, bocchettone senza autotenuta, nichelato

Angle lockshield, iron pipe connection, tail piece without auto-seal, nickel plated, brass cap

NICHT inspizierbares Schlossschild für Heizkörper, Winkel, Eisenrohranschluss,

Détendeur NON inspectionnable pour radiateurs, vanne d'équerre, raccord

Запорный клапан НЕ проверяемый для радиаторов, угловой, соединение

Cod./Code	Mis./Size	□/田	€
154607000	3/4"	10/40	14,34
154903002	3/8"	10/120	8,26
154905002	1/2"	10/120	7,67
154907002	3/4"	10/60	10,47



## IVR 547



Detentore NON ispezionabile dritto per radiatori, attacco tubo ferro, bocchettone con autotenuta, nichelato

Straight lockshield for radiators, with iron pipe connection, tail piece with auto-seal, nickel plated, brass cap

NICHT inspizierbarer gerader Schutzschild für Heizkörper, Eisenrohranschluss, Verbindung mit selbstdichtend, vernickelt

Détendeur NON inspectionnable droit pour radiateurs, raccord tube

Запорный клапан НЕ проверяемый прямой для радиаторов, трубное соединение

Cod./Code	Mis./Size	□/田	€
154703000	3/8"	10/120	7,77
154705000	1/2"	10/120	9,40
154707000	3/4"	10/60	13,10



## IVR 547/2



Detentore NON ispezionabile dritto per radiatori, attacco tubo ferro, bocchettone senza autotenuta, nichelato

Straight lockshield, with iron pipe connection, tail piece without auto-seal, nickel plated

NICHT inspizierbarer gerader Schutzschild für Heizkörper, Eisenrohranschluss, Anschluss ohne selbstdichtend, vernickelt

Détendeur NON inspectionnable droit pour radiateurs, raccord tube

Запорный клапан НЕ проверяемый прямой для радиаторов, трубное соединение

Cod./Code	Mis./Size	□/田	€
154703002	3/8"	10/120	7,41
154705002	1/2"	10/120	8,85
154707002	3/4"	10/60	11,75



## VALVOLE MANUALI - ATTACCO PEX-RAME MANUAL VALVES - PEX-COPPER CONNECTION

### IVR 540



Valvola per radiatori, a squadra con volantino manuale attacco PEX, multistrato e tubo rame, bocchettone con autotenuta, nichelata

Angle radiator valve with manual handle, PEX, multilayer and copper pipe connection, tail piece with auto-seal, nickel plated

Eckförmiges Heizkörperventil mit Handrad, Anschluss für PEX, Mehrschicht- und Kupferrohr, Verschraubung mit Selbstdichtung, vernickelt

Vanne pour radiateurs équerre avec volant manuel, fixation PEX, multicouche et tube en cuivre, raccord auto-étanche, nickelée

Угловой клапан с ручным управлением для радиаторов, соединения для: PEX, многослойной и медной трубы, патрубков с герметичной прокладкой, никелированный

Cod./Code	Mis./Size	Att./Conn.	□/田	€
154003160	3/8"	1/2"	10/60	8,04
154003180	3/8"	24-19	10/60	8,50
154005160	1/2"	1/2"	10/60	9,25
154005180	1/2"	24-19	10/60	9,48



### IVR 540/2



Valvola per radiatori, a squadra con volantino manuale, attacco PEX, multistrato e tubo rame, bocchettone senza autotenuta, nichelata

Angle radiator valve with manual handle, PEX, multilayer and copper pipe connection, tail piece without auto-seal, nickel plated

Eckförmiges Heizkörperventil mit Handrad, Anschluss für PEX, Mehrschicht- und Kupferrohr, Verschraubung ohne Selbstdichtung, vernickelt

Vanne pour radiateurs équerre avec volant manuel, fixation PEX, multicouche et tube en cuivre, raccord non auto-étanche, nickelée

Угловой клапан с ручным управлением для радиаторов, соединения для: PEX, многослойной и медной трубы, патрубков без герметичной прокладки, никелированный

Cod./Code	Mis./Size	Att./Conn.	□/田	€
154003162	3/8"	1/2"	10/60	7,67
154003182	3/8"	24-19	10/60	8,11
154005162	1/2"	1/2"	10/60	8,73
154005182	1/2"	24-19	10/60	8,97



### IVR 538



Valvola per radiatori, dritta con volantino manuale, attacco PEX, multistrato e tubo rame, bocchettone con autotenuta, nichelata

Straight radiator valve with manual handle, PEX, multilayer and copper pipe connection, tail piece with auto-seal, nickel plated

Gerades Heizkörperventil mit Handrad, Anschluss für PEX, Mehrschicht- und Kupferrohr, Verschraubung mit Selbstdichtung, vernickelt

Vanne pour radiateurs droite avec volant manuel, fixation PEX, multicouche et tube en cuivre, raccord auto-étanche, nickelée

Прямой клапан с ручным управлением для радиаторов, соединения для: PEX, многослойной и медной трубы, патрубков с герметичной прокладкой, никелированный

Cod./Code	Mis./Size	Att./Conn.	□/田	€
153803160	3/8"	1/2"	10/60	10,24
153803180	3/8"	24-19	10/60	10,54
153805160	1/2"	1/2"	10/60	11,16
153805180	1/2"	24-19	10/60	11,45



### IVR 538/2



Valvola per radiatori, dritta con volantino manuale, attacco PEX, multistrato e tubo rame, bocchettone senza autotenuta, nichelata

Straight radiator valve with manual handle, PEX, multilayer and copper pipe connection, tail piece without auto-seal, nickel plated

Gerades Heizkörperventil mit Handrad, Anschluss für PEX, Mehrschicht- und Kupferrohr, Verschraubung ohne Selbstdichtung, vernickelt

Vanne pour radiateurs droite avec volant manuel, fixation PEX, multicouche et tube en cuivre, raccord non auto-étanche, nickelée

Прямой клапан с ручным управлением для радиаторов, соединения для: PEX, многослойной и медной трубы, патрубков без герметичной прокладки, никелированный

Cod./Code	Mis./Size	Att./Conn.	□/田	€
153803162	3/8"	1/2"	10/60	9,89
153803182	3/8"	24-19	10/60	10,20
153805162	1/2"	1/2"	10/60	10,76
153805182	1/2"	24-19	10/60	10,98





## DETENTORI - ATTACCO PEX-RAME LOCKSHIELD - PEX-COPPER CONNECTION

### IVR 541



Detentore a squadra per radiatori, attacco tubo rame, bocchettone con autotenuta, nichelato

Angle lockshield for radiators, with PEX, multilayer and copper pipe connection, tail piece with auto-seal, nickel plated

Eckförmige Rücklaufverschraubung, mit Anschluss für Kupferrohr, Verschraubung mit Selbstdichtung, vernickelt

Coude de réglage équerre, fixation tube en cuivre, raccord autoétanche, nickelée

Угловой отсекающий клапан для радиаторов, соединения для медной трубы, патрубков с герметичной прокладкой, никелированный

Cod./Code	Mis./Size	Att./Conn.	□/⊕	€
154103160	3/8"	1/2"	10/120	7,10
154103180	3/8"	24-19	10/120	7,40
154105160	1/2"	1/2"	10/120	8,16
154105180	1/2"	24-19	10/120	8,43



### IVR 541/2



Detentore a squadra per radiatori, attacco tubo rame, bocchettone senza autotenuta, nichelato

Angle lockshield for radiators with PEX, multilayer and copper pipe connection, tail piece without auto-seal, nickel plated

Eckförmige Rücklaufverschraubung für Heizkörper, mit Anschluss für Kupferrohr, Verschraubung ohne Selbstdichtung, vernickelt

Coude de réglage équerre, fixation tube en cuivre, raccord non autoétanche, nickelée

Угловой отсекающий клапан для радиаторов, соединения для медной трубы, патрубков без герметичной прокладки, никелированный

Cod./Code	Mis./Size	Att./Conn.	□/⊕	€
154103162	3/8"	1/2"	10/120	6,69
154103182	3/8"	24-19	10/120	7,04
154105162	1/2"	1/2"	10/120	7,62
154105182	1/2"	24-19	10/120	7,90



### IVR 539



Detentore dritto per radiatori, attacco tubo rame, bocchettone con autotenuta, nichelato

Straight lockshield with PEX, multilayer and copper pipe connection, tail piece with auto-seal, nickel plated

Gerade Rücklaufverschraubung für Heizkörper, mit Anschluss für Kupferrohr, Verschraubung mit Selbstdichtung, vernickelt

Coude de réglage équerre, fixation tube en cuivre, raccord autoétanche, nickelée

Прямой отсекающий клапан для радиаторов, соединения для медной трубы, патрубков с герметичной прокладкой, никелированный

Cod./Code	Mis./Size	Att./Conn.	□/⊕	€
153903160	3/8"	1/2"	10/120	9,57
153903180	3/8"	24-19	10/120	9,63
153905160	1/2"	1/2"	10/120	10,84
153905180	1/2"	24-19	10/120	10,90



### IVR 539/2



Detentore dritto per radiatori, attacco tubo rame, bocchettone senza autotenuta, nichelato

Straight lockshield for radiators with PEX, multilayer and copper pipe connection, tail piece without auto-seal, nickel plated

Gerade Rücklaufverschraubung für Heizkörper, mit Anschluss für Kupferrohr, Verschraubung ohne Selbstdichtung, vernickelt

Coude de réglage droit, fixation tube en cuivre, raccord non autoétanche, nickelée

Прямой отсекающий клапан для радиаторов, соединения для медной трубы, патрубков без герметичной прокладки, никелированный

Cod./Code	Mis./Size	Att./Conn.	□/⊕	€
153903162	3/8"	1/2"	10/120	9,20
153903182	3/8"	24-19	10/120	9,24
153905162	1/2"	1/2"	10/120	10,36
153905182	1/2"	24-19	10/120	10,40



## VALVOLE AD H H VALVES

### IVR 753



Valvola "H" con attacco maschio per impianti bitubo con derivazioni a parete  
"H" valve with male connection for double pipe systems with wall pipes  
Zweirohr-Hahnblock Eckform mit AG-Anschluß  
Pièce "H" avec embout mâle pour systèmes bitube avec dérivations murales  
Клапан "H" с наружной резьбой, для двухтрубных систем, с возможностью монтажа в стену

Cod./Code	Mis./Size	□/田	€
175307001	3/4"	12/48	21,36



### IVR 754



Valvola "H" con attacco maschio per impianti monotubo/bitubo (con bypass regolabile 50-100%) con derivazioni a parete  
"H" valve with male connection for single/double pipe systems (with adjustable bypass 50-100%) with wall pipes  
Ein-/Zweirohr-Hahnblock (mit regelbarer Bypass 50-100%) Eckform mit AG-Anschluß  
Pièce "H" avec embout mâle pour systèmes monotube/bitube (avec bypass réglable 50-100%) avec dérivations murales  
Клапан "H" с наружной резьбой для одно/двухтрубных систем (с регулируемым бай-пассом 50-100%) с возможностью монтажа в стену

Cod./Code	Mis./Size	□/田	€
175407001	3/4"	12/48	26,68



### IVR 755



Valvola "H" con attacco maschio per impianti bitubo con derivazioni a pavimento  
"H" valve with male connection for double pipe systems with floor pipes  
Zweirohr-Hahnblock Durchgangsform mit AG-Anschluß  
Pièce "H" avec embout mâle pour systèmes bitube avec dérivations au sol  
Клапан "H" с наружной резьбой, для двухтрубных систем, с возможностью монтажа в пол

Cod./Code	Mis./Size	□/田	€
175507001	3/4"	12/48	21,46



### IVR 756



Valvola "H" con attacco maschio per impianti monotubo/bitubo (con bypass regolabile 50-100%) con derivazioni a pavimento  
"H" valve with male connection for single/double pipe systems (with adjustable bypass 50-100%) with floor pipes  
Ein-/Zweirohr-Hahnblock (mit regelbarer Bypass 50-100%) Durchgangsform mit AG-Anschluß  
Pièce "H" avec embout mâle pour systèmes monotube/bitube (avec bypass réglable 50-100%) avec dérivations au sol  
Клапан "H" с наружной резьбой, для одно/двухтрубных систем (с регулируемым бай-пассом 50-100%), с возможностью монтажа в пол

Cod./Code	Mis./Size	□/田	€
175607001	3/4"	12/48	26,25



### IVR 758



Adattatore per valvole "H"  
Adapter for "H" valves  
Adapter für "H"-Ventile  
Adaptateur pour pièces "H"  
Адаптер для "H" клапанов

Cod./Code	Mis./Size	□/田	€
175807051	3/4"	100/800	2,19

## ADATTATORI ADAPTERS

### IVR 580



Adattatori preassemblati per tubo rame - Nichelato  
Adapters preassembled for copper pipe - Nickel plated  
Vormontierter Adapter / Zwischenstücke für Kupferrohr - Vernickelt  
Adaptateurs préassemblés pour tubes en cuivre - Niklé  
Адаптеры в сборе для медной трубы - никелированные

Cod./Code	Mis./Size	Att./Conn.	□/⊕	€
158005100	10	1/2"	20/300	2,50
158005120	12	1/2"	20/300	2,50
158005140	14	1/2"	20/300	2,50
158005150	15	1/2"	20/300	2,50
158005160	16	1/2"	20/300	2,50
158007121	12	3/4" EK	20/300	4,19
158007141	14	3/4" EK	20/300	4,19
158007151	15	3/4" EK	20/300	4,19
158007161	16	3/4" EK	20/300	4,19
158024101	10	24-19	20/300	3,06
158024121	12	24-19	20/300	3,06
158024141	14	24-19	20/300	3,06
158024151	15	24-19	20/300	3,06
158024161	16	24-19	20/300	3,06
158024181	18	24-19	20/300	4,00



### IVR 581



Adattatori universali a compressione per tubi multistrato e polietilene reticolato PEX, nichelati - Nickelato  
Adapters for multilayer pipe and cross-linked polyethylene pipe PEX, nickel plated - Nickel plated  
Universal-Adaptern-Zwischenstücke für Mehrschichtrohren und aus vernetztem und vernickeltem Polyethylen PEX -vernickelt  
Adaptateurs universels à compression pour tubes multicouche et polyéthylène réticulé PEX - nickelés - nichelés  
Никелированные универсальные компрессионные адаптеры для металлопластиковых труб ,труб из сшитого полиэтилена PEX, никелированных труб

Cod./Code	Mis./Size	Att./Conn.	□/⊕	€
158105143	14 x 2	1/2"	20/300	2,81
158105156	15 x 2,5	1/2"	20/300	2,81
158105163	16 x 2	1/2"	20/300	2,81
158105164	16 x 2,25	1/2"	20/300	2,81
158107141	14 x 2	3/4" EK	20/300	4,87
158107163	16 x 2	3/4" EK	20/300	3,13
158107171	17 x 2	3/4" EK	20/300	4,87
158107181	18 x 2	3/4" EK	20/300	4,87
158107201	20 x 2	3/4" EK	20/300	4,87
158110203	20 x 2	1"	10/150	9,69
158110255	25 x 2,3	1"	10/150	6,56
158110256	25 x 2,5	1"	10/150	6,56
158110268	26 x 3	1"	10/150	6,56
158124141	14 x 2	24-19	20/300	3,75
158124162	16 x 2,25	24-19	20/300	3,75
158124163	16 x 2	24-19	20/300	2,93
158124171	17 x 2	24-19	20/300	5,00
158124181	18 x 2	24-19	20/300	5,00
158124201	20 x 2	24-19	20/300	5,00



## KIT PER RADIATORI KIT FOR RADIATORS

### IVR 436



Kit valvole termostattabili a squadra per tubo rame, PEX e multistrato, composto da: valvola SATURN e detentore JUPITER, volantino manuale, 2+2 DX/SX riduzioni con guarnizione, valvola scarico aria, tappo ottone con cappuccio bianco

Thermostatic angle radiator valve kit for copper, PEX and multilayer pipe, includes: SATURN radiator valve and JUPITER lockshield, manual handle, 2+2 RT/LF reductions, manual air vent valve, brass plug with white cap

KIT (Garnitur) Thermostatventile, eckförmig für Kupfer-, PEX- und Mehrschichtrohr, bestehend aus: Ventil SATURN und Rücklaufverschraubung JUPITER, Handrad, 2+2 Reduzierstücke rechts/links mit Dichtung, Luftablassventil, Messingdeckel mit weißer Kappe

Kit vannes thermostatizables équerre pour tube en cuivre, PEX et multicouche, composé de: vanne SATURN et coude de réglage JUPITER, volant manuel, 2+2 DX/SX réductions avec joint, vanne évacuation air, bouchon en laiton avec capuchon blanc

Комплект термостатических угловых клапанов для медной, многослойной и PEX труб. В комплект входит: радиаторный клапан Saturn и отсекающий вентиль Jupiter, регулятор ручной, 2 + 2 пр./лев. футорки с прокладками, ручной воздухоотводчик, заглушки из латуни с белым пластиковым колпачком

Cod./Code	Mod./Model	Mis./Size	Att./Conn.	□/田	€
143603682	kit Saturn Sq TR	3/8"	24-19	7	35,22
143605682	kit Saturn Sq TR	1/2"	24-19	7	38,34



### IVR 435



Kit valvole manuali a squadra per tubo rame, PEX e multistrato, composto da: valvola e detentore MERCURY, 2+2 DX/SX riduzioni con guarnizione siliconica, valvola scarico aria, tappo ottone con cappuccio bianco

Manual angle radiator valve kit for copper, PEX and multilayer pipe, includes: MERCURY radiator valve and lockshield, 2+2 RT/LF reductions with silicone gasket, manual air vent valve, brass plug with white plastic cap

KIT (Garnitur) manuelles Heizkörperventile, eckförmig für Kupfer-, PEX - und Mehrschichtrohr, bestehend aus: Ventil und Rücklaufverschraubung MERCURY, 2+2 rechts/links, Reduzierstücke mit Silikondichtapfe, Luftablassventil, Messingdeckel mit weißer Kappe

Kit vannes manuelles équerre pour tube en cuivre, PEX et multicouche, composé de: vanne et coude de réglage MERCURY, 2+2 DX/SX réductions avec joint silicone, vanne d'évacuation de l'air, bouchon en laiton avec capuchon blanc

Комплект ручных угловых клапанов для медной, многослойной и PEX трубы. В комплект входит : радиаторный клапан и отсекающий клапан MERCURY, 2 + 2 пр./лев. футорки с силиконовыми прокладками, ручной воздухоотводчик, заглушка из латуни с белым пластиковым колпачком

Cod./Code	Mod./Model	Mis./Size	Att./Conn.	□/田	€
143503682	kit Mercury Sq TR	3/8"	24-19	7	29,43
143505682	kit Mercury Sq TR	1/2"	24-19	7	31,54



## DEFANGATORE MAGNETICO MAGNETIC DIRT SEPARATOR

### IVR 909



Defangatore magnetico completo di tappo, bocchettoni e rubinetto di scarico

Magnetic Dirt Filter, cap, fittings and drain cock with hose connection

Schlammabscheider mit magnet, kappe, anschluss-stuck und entleerungshahn mit schlauch-anschluss

Séparateur de boue magnétique avec bouchon, raccords et robinet de vidange

Магнитный грязеуловитель (дешламатор) с заглушкой, фитингами и сливным краном с насадкой для шланга.

Cod./Code	Mis./Size	□/田	€
190907000	3/4"	1/6	105,95



**Configurazione  
a 180°**



**Configurazione  
a 90°**



## VALVOLE FAN-COIL FAN-COIL VALVES

### IVR 748



Valvola fan-coil a 2 vie - attacchi M/M  
 Fan-coil 2-way valve - M/M  
 2-Wege Kugelhan für Gebläsekonvektoren - AG/AG  
 Vanne à 2 voies pour ventilo-convecteurs - M/M  
 2-ходовой клапан для фанкойлов, соединения Н/Н

Cod./Code	Mis./Size	□/⊞	€
174805001	1/2"	1/100	15,49
174807001	3/4"	1/100	15,63
174810001	1"	1/50	22,39



### IVR 749



Valvola fan-coil a 3 vie - attacchi M/M  
 Fan-coil 3-way valve - M/M  
 3-Wege Kugelhan für Gebläsekonvektoren - AG/AG  
 Vanne à 3 voies pour ventilo-convecteurs - M/M  
 3-ходовой клапан для фанкойлов, соединения Н/Н

Cod./Code	Mis./Size	□/⊞	€
174905001	1/2"	1/100	20,02
174907001	3/4"	1/100	21,14
174910001	1"	1/50	28,27



### IVR 750



Valvola fan-coil a 4 vie - attacchi M/M  
 Fan-coil 4-way valve - M/M  
 4-Wege Kugelhan für Gebläsekonvektoren - AG/AG  
 Vanne à 4 voies pour ventilo-convecteurs - M/M  
 4-ходовой клапан для фанкойлов, соединения Н/Н

Cod./Code	Mis./Size	□/⊞	€
175005001	1/2"	1/50	23,76
175007001	3/4"	1/50	24,03
175010001	1"	1/25	36,43



## GRUPPO ALIMENTAZIONE AUTOMATIC FILLING UNIT

### IVR 334



Gruppo di alimentazione serie pesante per impianti di riscaldamento a circuito chiuso con riduttore di pressione, attacco manometro da 1/4", filtro e rubinetto di intercettazione. Entrata F, uscita M a bocchettone.

Automatic filling unit with pressure reducer, 1/4" manometer connection, filter and shut off valve, with inlet F thread and M union connection.

Versorgungsgruppe für Heizungssystemen mit geschlossenem Kreislauf mit Druckminderer - schwere Ausführung, Manometeranschluß 1/4", Filter und Absperrventil. Eingang IG und Ausgang AG mit Anschluss

Groupe d'alimentation série lourde pour implémentation de chauffage à circuit fermé avec reducteur de pression, fixations manomètre de 1/4", filtre et robinet d'interception. Entrée F sortie M à raccord.

Группа подпитки, усиленная версия для закрытых систем отопления, включает редуктор давления, соединение под манометр 1/4", фильтр и перекрывающий клапан. Соединения: В со стороны входа и сгон с накидной гайкой со стороны выхода

Cod./Code	Mis./Size	□/田	€
133405001	1/2"	1/15	44,01



### IVR 336



Gruppo di alimentazione serie leggera per impianti di riscaldamento a circuito chiuso con riduttore di pressione, attacco manometro da 1/4", filtro e rubinetto di intercettazione. Entrata M a bocchettone, uscita F

Automatic filling unit for closed-circuit heating systems with pressure reducer, 1/4" manometer connection, filter and shut-off valve. With inlet M union connection and F thread.

Versorgungsgruppe für Heizungssysteme mit geschlossenem Kreislauf mit Druckminderer - leichte Ausführung, Manometeranschluß 1/4", Filter und Absperrventil. Eingang (AG) und Ausgang (IG) mit Anschluss.

Groupe d'alimentation série légère pour implémentation de chauffage à circuit fermé avec reducteur de pression, fixations manomètre de 1/4", filtre et robinet d'interception. Entrée M raccord, sortie F.

Группа подпитки, облегченная версия, для закрытых систем отопления, включает редуктор давления, соединение под манометр 1/4", фильтр и перекрывающий клапан. Соединения: сгон с накидной гайкой со стороны входа и В со стороны выхода.

Cod./Code	Mis./Size	□/田	€
133605001	1/2"	1/25	33,86



### IVR 358



Manometro diametro 50 - 63 mm - attacco radiale - per IVR 304

Radial pressure gauge diameter 50 - 63 mm - for IVR 304

Manometer Ø 50 - 63 mm - Anschluss unten, für IVR 304

Manometre Ø 50 - 63mm - fixation radiale pour ivr 304

Радиальный манометр Ø 50-63 мм для IVR 304

Cod./Code	Mod./Model	Mis./Size	Ø	□/田	€
135802116	scala/scale 0-16 bar	1/4"	50	1/100	11,87
135802206	scala/scale 0-6 bar	1/4"	63	1/100	11,87
135802210	scala/scale 0-10 bar	1/4"	63	1/100	11,87
135802216	scala/scale 0-16 bar	1/4"	63	1/100	11,87



## VALVOLE DI BILANCIAMENTO BALANCING VALVES

### IVR 340



Valvola in ottone DZR ad orificio fisso, filettata F/F (ISO 228/1 per DN15/20, ISO7/1 Rp oltre). Brugola di presettaggio in dotazione. Condizioni di esercizio: da -10° C a +130° C

Fixed orifice DZR brass double reg. valve, threaded F/F (ISO 228/1 for DN15/20, ISO7/1 Rp above). Valve supplied with allen key for setting. Working conditions: -10°C to +130°C

Ventil aus DZR-Messing mit fester Öffnung, alle Anschlüsse ig (ISO 228/1 für DN15/20, ISO7/1 Rp höher). Ausstattung mit Inbusschlüssel zur Voreinstellung. Betriebstemperatur von -10° C zu + 130° C

Vanne d'équilibrage statique en laiton DZR, orifice fixe, fileté F/F (ISO 228/1 pour DN15 / 20, ISO7 / Rp 1 au-dessus). Valve fourni avec une clé Allen pour le réglage. Conditions de travail: -10° C

Балансировочный клапан из латуни марки DZR, фиксированное отверстие, резьбовое соединение В/В (ISO 228/1 для DN15/20, ISO7/1). Клапан поставляется с ключом для регулировки. Рабочая температура от -10° C до +130° C.

Cod./Code	Mis./Size	□/田	€
134005001	1/2"	4/16	78,76
134007001	3/4"	5/20	84,17
134010001	1"	4/16	88,06
134012001	1"1/4	4/16	133,02
134015001	1"1/2	2/8	160,94
134020001	2"	2/8	233,10



### IVR 342



Valvola in ghisa a doppia reg. con prese di pressione in DZR (non montate), ad orificio variabile, flangiata PN16 (EN1092-2). Condizioni di esercizio: da -10° C a +120° C

Cast iron double setting valve with test points in DZR brass (unmounted), variable orifice, Flanged PN16 (EN1092-2). Working conditions: -10° C to +120° C

Ventil aus Gusseisen - Doppelseinstellung mit DZR Drucksteckdose (nicht eingebaut), mit Variable Öffnung, Flansch PN16 (EN 1092-2). Betriebstemperatur: -10° C to +120° C

Vanne d'équilibrage statique en fonte, avec prises de pression pas montée, orifice variable, pourvue de brides PN16 (EN1092-2). Conditions de travail: -10° C à + 120° C

Чугунный клапан с двойной регулировкой и вариационным отверстием, вставки для контроля давления из латуни DZR (не в сборе), фланцы PN16 (EN1092-2). Рабочая температура: от -10° C до +120° C

Cod./Code	DN	□/田	€
134225001	65	1	521,17
134230001	80	1	808,30
134240001	100	1	931,51
134250001	125	1	1.306,47
134260001	150	1	1.641,34
134280001	200	1	3.598,69
134290001	250	1	5.284,84
134295001	300	1	7.166,72



### IVR 341



Valvola in bronzo ad orificio variabile, filettata F/F ISO 228/1, brugola di presettaggio in dotazione. Condizioni di esercizio da -10° a +130°

Bronze valve with variable orifice, F/F ISO 228/1 threaded unions, supplied with Allen key for setting. Working temperatures: -10° +130°

Ausgleichventil aus Rotguss mit veränderbarer Öffnung, IG/IG Gewinde ISO 228/1, geliefert mit dem Inbusschlüssel zur Voreinstellung. Betriebstemperaturen: -10° +130°

Vanne en bronze avec orifice variable, filetage F/F ISO 228/1, fournie avec la clé Allen pour le réglage. Températures de fonctionnement: -10° +130°

Бронзовый клапан с вариационным отверстием, резьбовое соединение В/В ISO 228/1, поставляется с установочным ключом. Рабочая температура от -10° C до + 130° C

Cod./Code	Mis./Size	□/田	€
134105001	1/2"	4/16	74,24
134107001	3/4"	5/20	81,04
134110001	1"	4/16	84,48
134112001	1"1/4	4/16	123,32
134115001	1"1/2	2/8	151,58
134120001	2"	2/8	201,80



## IVR 344



Valvola di bilanciamento automatico in ottone DZR con bocchettoni filettata F/F ISO 7/1 RP condizioni di esercizio da -10° a +130°

Automatic balancing valve in DZR brass with tail piece F/F ISO 7/1 RP thread working temperatures -10° +130°

Automatisches Ausgleichsventil aus DZR-Messing mit Rohrverschraubungen Gewinde IG/IG ISO 7/1 RP Betriebstemperaturen -10° +130°

Vanne d'équilibrage en laiton DZR avec raccord de tuyauterie température de fonctionnement -10° +130°

Автоматический балансировочный клапан из латуни DZR, со сгоном, резьбовые соединения В/В ISO 7/1 RP. Рабочая температура от -10 ° до + 130 °С

Cod./Code	Mis./Size	□/田	€
134405001	1/2"	4/16	76,04
134407001	3/4"	4/16	83,72
134410001	1"	4/16	93,64
134412001	1"1/4	4/16	185,45
134415001	1"1/2	2/8	197,08
134420001	2"	2/8	229,94



## IVR 344 C



Cartuccia stabilizzatrice di portata per valvola di bilanciamento automatico

Cartridge for the stabilisation of water flow for automatic balancing

Kartusche zur Stabilisierung des Wasserflusses für automatischen Ausgleich

Cartouche de stabilisation du débit pour la vanne d'équilibrage automatique

Картридж стабилизации потока для автоматического балансировочного клапана

Cod./Code	Mod./Model	□/田	€
134452001	17-240 kPa 468 l/h	1	89,42
134452002	17-240 kPa 540 l/h	1	89,42
134452003	17-240 kPa 612 l/h	1	89,42
134452004	17-240 kPa 684 l/h	1	89,42
134452011	18-240 kPa 756 l/h	1	89,42
134452012	18-240 kPa 864 l/h	1	89,42
134452013	18-240 kPa 972 l/h	1	89,42
134452014	18-240 kPa 1080 l/h	1	89,42
134452015	18-240 kPa 1188 l/h	1	89,42
134452016	18-240 kPa 1296 l/h	1	89,42
134452017	18-240 kPa 1440 l/h	1	89,42
134452021	19-240 kPa 1620 l/h	1	89,42
134452022	19-240 kPa 1800 l/h	1	89,42
134452031	21-240 kPa 1980 l/h	1	89,42
134452041	22-240 kPa 2160 l/h	1	89,42
134452051	24-240 kPa 2376 l/h	1	89,42
134452052	24-240 kPa 2592 l/h	1	89,42
134453001	13-230 kPa 1116 l/h	1	121,73
134453002	13-230 kPa 1224 l/h	1	121,73
134453003	13-230 kPa 1332 l/h	1	121,73
134453011	14-230 kPa 1440 l/h	1	121,73
134453012	14-230 kPa 1656 l/h	1	121,73
134453013	14-230 kPa 1800 l/h	1	121,73
134453014	14-230 kPa 1980 l/h	1	121,73
134453015	14-230 kPa 2088 l/h	1	121,73
134453016	14-230 kPa 2232 l/h	1	121,73
134453021	15-230 kPa 2412 l/h	1	121,73
134453022	15-230 kPa 2664 l/h	1	121,73
134453023	15-230 kPa 2988 l/h	1	121,73
134453024	15-230 kPa 3240 l/h	1	121,73
134453025	15-230 kPa 3492 l/h	1	121,73
134453026	15-230 kPa 3780 l/h	1	121,73
134453027	15-230 kPa 4320 l/h	1	121,73
134453031	16-230 kPa 4680 l/h	1	121,73
134453041	17-230 kPa 5184 l/h	1	121,73
134453042	17-230 kPa 5616 l/h	1	121,73
134453051	18-230 kPa 6048 l/h	1	121,73
134453061	19-230 kPa 6480 l/h	1	121,73
134453062	19-230 kPa 7056 l/h	1	121,73



## IVR 346



Prese di pressione, filettata M 1/4" ISO 7/1 R in ottone DZR

Pressure test point, M 1/4" ISO 7/1 R in DZR brass

Drucksteckdose, AG 1/4" ISO 7/1 R aus DZR-Messing

Prises de pression, filetée M 1/4" ISO 7/1 R en laiton DZR

Пьезометрические ниппели для измерения значений давления, резьба H 1/4" ISO 7/1 R, из латуни DZR

Cod./Code	Mod./Model	Mis./Size	□/⊕	€
134610201	Presa press cravatta blu	1/4"	10/180	9,88
134610202	Presa press cravatta ros	1/4"	10/180	9,88
134630201	Kit pr press c/prol crav blu	1/4"	5/90	31,40
134630202	Kit pr press c/prol crav ros	1/4"	5/90	31,40



## IVR 327



Valvola di controllo indipendente dalla pressione PICV in ottone DZR. Filettata MM per bocchettone (ISO228/1)

Pressure independent control valve in DZR brass PICV. MM for tail piece (ISO228/1)

Druckunabhängiges Regelventil aus DZR-Messing. AG/AG für Anschluss (ISO228/1)

Vanne de contrôle indépendante de la pression en laiton DZR. MM pour le raccord tuyauterie

Регулирующий клапан независимый от давления PICV (НДПК) из латуни DZR. Резьбовые соединения H/H для накидной гайки (ISO228/1)

Cod./Code	Mis./Size	DN	□/⊕	€
132707001	3/4"	15	1	132,34
132707002	3/4"	15	1	119,73
132707003	3/4"	15	1	119,73
132707004	3/4"	15	1	108,43
132710001	1"	20	1	208,27
132710002	1"	20	1	193,61
132712001	1"1/4	25	1	266,83
132712002	1"1/4	25	1	257,05
132715001	1"1/2	32	1	281,50
132715002	1"1/2	32	1	266,83



## IVR 335



Valvola di controllo indipendente dalla pressione PICV in ottone DZR filettata FF (ISO 7/1 Rp)

DZR brass pressure independent control valve (PICV), threaded F/F (ISO 7/1 Rp)

Druckunabhängiges Regelventil (PICV) aus DZR-Messing, IG/IG (ISO 7/1 Rp)

Vanne de contrôle indépendante de la pression en laiton DZR (PICV), F/F (ISO 7/1 Rp)

Регулирующий клапан независимый от давления PICV (НДПК) из латуни DZR. Резьбовые соединения В/В (ISO 7/1Rp)

Cod./Code	Mis./Size	DN	□/⊕	€
133515001	1"1/2	40	1	625,78
133520001	2"	50	1	645,33



## IVR 348



Attuatori elettrici 0-10 V; Tensione di alimentazione: 24 V Ac/Dc; Connessione filettata: M30x1,5; Grado di protezione: IP 43

Electrical actuators 0-10 V; Power supply voltage: 24 V Ac/Dc; Threaded connection: M30x1.5; Protection rating: IP 43

Elektrische Aktuatoren 0-10 V; Versorgungsspannung: 24 V Ac/Dc; Gewindeanschluss: M30x1,5; Schutzgrad: IP 43

Actionneurs électriques 0-10 V ; Tension d'alimentation : 24 V Ac/Dc ; Connexion filetée : M30x1,5 ; Degré de protection IP 43

Электроприводы 0-10 В; Напряжение питания: 24 В пер.т./пост.т.; Резьбовое соединение: М30х1,5; Степень защиты: IP 43

Cod./Code	Mod./Model	□/⊕	€
134801000	PICV 1/2"-1"1/4	1	184,80
134802000	PICV 1"1/2-2"	1	503,56





## IVR 319



Valvola di controllo indipendente dalla pressione PICV in ghisa flangiata PN 16

Pressure independent control valve in cast iron PICV with flanges PN 16

Druckunabhängiges Regelventil aus Gusseisen mit Flanschen PN 16

Vanne de contrôle indépendante de la pression en fonte, brides PN 16

Регулирующий клапан независимый от давления PICV (НДРК) из чугуна, фланцы PN 16

Cod./Code	DN	□/田	€
131925001	65	1	3.500,45
131930001	80	1	3.891,56
131940001	100	1	4.522,22
131950001	125	1	6.428,91
131960001	150	1	9.279,14



## IVR 991



Strumento elettronico per la misura della pressione differenziale e per il calcolo della portata nei sistemi di bilanciamento

Digital manometer for measuring differential pressure and calculating the flow of balancing systems

Digitaldruckmesser zum Messen von dem Differenzdruck und zum Kalkulieren von dem Durchfluss in den Ausgleichssystemen

Manomètre numérique pour la mesure de la pression différentielle et pour le calcul du flux des systèmes d'équilibrage

Электронный инструмент для измерения перепадов давления и расчета потока при балансировке систем

Cod./Code	□/田	€
199100020	1	5.114,04

## VALVOLE DI SICUREZZA E SCARICO CALDAIA SAFETY VALVES

### IVR 718



Gruppo di sicurezza caldaia in ottone - valvola di intercettazione - manometro - scarico aria automatico - valvola di sicurezza

Brass safety set - automatic shut-off valve - pressure gauge - automatic air-vent - safety valve

Sicherheitsgruppe für Heizkessel aus Messing - Abfang / Absperrenteil - Manometer - automatisches Entlüftung - Sicherheitsventil

Groupe de sécurité chaudière en laiton, vanne d'interception, manometre - sortie aire automatique - vanne de sécurité

Группа безопасности котла латунная - запорный клапан - манометр - автоматический воздухоотводчик - предохранительный клапан

Cod./Code	Mod./Model	Mis./Size	□/⊕	€
171810020	2,0 bar	1"	1/7	69,38
171810025	2,5 bar	1"	1/7	69,38
171810030	3,0 bar	1"	1/7	69,38
171810040	4,0 bar	1"	1/7	69,38
171810050	5,0 bar	1"	1/7	69,38



### IVR 718/C



Guscio di coibentazione per GRUPPO SAFETY

Insulation shell for SAFETY SET

Isolierhülse für SAFETY SET

Coque isolante pour GROUPE SAFETY

Изолирующий элемент для ГРУППЫ БЕЗОПАСНОСТИ

Cod./Code	□/⊕	€
335800421	1/5	24,86



### IVR 355



Valvola di sicurezza M/F

Safety valve M/F

Sicherheitsventile AG/IG

Souape de sécurité M/F

Предохранительный клапан Н/В

Cod./Code	Mod./Model	Mis./Size	□/⊕	€
135505151	1,5 bar	1/2"	10/150	6,83
135505201	2,0 bar	1/2"	10/150	6,83
135505251	2,5 bar	1/2"	10/150	6,83
135505301	3,0 bar	1/2"	10/150	6,83
135505401	4,0 bar	1/2"	10/150	6,83
135505501	5,0 bar	1/2"	10/150	6,83
135505601	6,0 bar	1/2"	10/150	6,83



### IVR 356



Valvola di sicurezza M/F - con attacco manometro 1/4"

Safety valve M/F - with manometer connection 1/4"

Sicherheitsventile AG/IG - mit manometeranschluss 1/4"

Souape de sécurité M/F - avec fixations pour le manomètre 1/4"

Предохранительный клапан В/Н - с соединением для манометра 1/4"

Cod./Code	Mod./Model	Mis./Size	□/⊕	€
135605151	1,5 bar	1/2"	10/100	9,01
135605201	2,0 bar	1/2"	10/100	9,01
135605251	2,5 bar	1/2"	10/100	9,01
135605301	3,0 bar	1/2"	10/100	9,01
135605401	4,0 bar	1/2"	10/100	9,01
135605501	5,0 bar	1/2"	10/100	9,01
135605601	6,0 bar	1/2"	10/100	9,01



## IVR 350



Valvola di sicurezza F/F  
Safety valve F/F  
Sicherheitsventile IG/IG  
Soupape de sécurité F/F  
Предохранительный клапан В/В

Cod./Code	Mod./Model	Mis./Size	□/田	€
135005151	1,5 bar	1/2"	10/150	6,83
135005201	2,0 bar	1/2"	10/150	6,83
135005251	2,5 bar	1/2"	10/150	6,83
135005301	3,0 bar	1/2"	10/150	6,83
135005401	4,0 bar	1/2"	10/150	6,83
135005501	5,0 bar	1/2"	10/150	6,83
135005601	6,0 bar	1/2"	10/150	6,83
135007151	1,5 bar	3/4"	10/140	10,74
135007201	2,0 bar	3/4"	10/140	10,74
135007251	2,5 bar	3/4"	10/140	10,74
135007301	3,0 bar	3/4"	10/140	10,74
135007401	4,0 bar	3/4"	10/140	10,74
135007501	5,0 bar	3/4"	10/100	10,74
135007601	6,0 bar	3/4"	10/140	10,74
135010151	1,5 Bar	1"	10/60	15,95
135010201	2,0 bar	1"	10/60	15,95
135010251	2,5 bar	1"	10/60	15,95
135010301	3,0 bar	1"	10/60	15,95
135010401	4,0 bar	1"	10/60	15,95
135010501	5,0 bar	1"	10/60	15,95
135010601	6,0 bar	1"	10/60	15,95



## IVR 351



Valvola di sicurezza F/F - con attacco manometro 1/4"  
Safety valve F/F with manometer connection 1/4"  
Sicherheitsventil IG/IG mit Druckmesseranschluss 1/4"  
Soupape de sécurité F/F avec fixation manomètre 1/4"  
Предохранительный клапан В/В - с соединением для манометра 1/4"

Cod./Code	Mod./Model	Mis./Size	□/田	€
135105151	1,5 bar	1/2"	10/150	9,01
135105201	2,0 bar	1/2"	10/150	9,01
135105251	2,5 bar	1/2"	10/150	9,01
135105301	3,0 bar	1/2"	10/150	9,01
135105401	4,0 bar	1/2"	10/150	9,01
135105501	5,0 bar	1/2"	10/150	9,01
135105601	6,0 bar	1/2"	10/150	9,01



## IVR 347



Valvola di sicurezza doppia funzione - temperatura e pressione attacchi filettati MF  
Double-use safety valve - temperature and pressure M/F  
Sicherheitsventil mit doppeltem Einsatz - Temperatur und Druck, AG/IG  
Soupape de sécurité avec double fonction - température et pression, M/F  
Двухфункциональный предохранительный клапан (температура и давление), резьбовые соединения Н/В

Cod./Code	Mod./Model	Mis./Size	□/田	€
134705053	3,0 bar	1/2" x 1/2"	1/24	45,08
134705054	4,0 bar	1/2" x 1/2"	1/24	45,08
134705056	6,0 bar	1/2" x 1/2"	1/24	45,08
134705057	7,0 bar	1/2" x 1/2"	1/24	45,08
134705058	8,0 bar	1/2" x 1/2"	1/24	45,08
134707053	3,0 bar	3/4" x 1/2"	1/24	44,79
134707054	4,0 bar	3/4" x 1/2"	1/24	44,79
134707056	6,0 bar	3/4" x 1/2"	1/24	44,79
134707057	7,0 bar	3/4" x 1/2"	1/24	44,79
134707058	8,0 bar	3/4" x 1/2"	1/24	44,79
134707073	3,0 bar	3/4" x 3/4"	1/24	49,16
134707074	4,0 bar	3/4" x 3/4"	1/24	49,16
134707076	6,0 bar	3/4" x 3/4"	1/24	49,16
134707077	7,0 bar	3/4" x 3/4"	1/24	49,16
134707078	8,0 bar	3/4" x 3/4"	1/24	49,16



## IVR 369



Valvola limitatrice di pressione a squadra a tenuta metallica  
Angled pressure limiting valve with metal seal  
Druckbegrenzungsventil zur Abdichtung  
Limiteur de pression en forme d'équerre à étanchéité métallique  
Угловой предохранительный клапан, с металлическим уплотнением

Cod./Code	Mis./Size	□/⊞	€
136905001	1/2"	10/40	30,76
136907001	3/4"	8/32	43,06
136910001	1"	6/24	58,06
136912001	1"1/4	15	88,33
136915001	1"1/2	10	113,19
136920001	2"	10	151,08



## IVR 352



Valvola di sicurezza per scaldabagni - tipo leggero  
Safety valve for water heaters - light version  
Sicherheitsventil für Wasserkessel - leichte Ausführung  
Soupape de sécurité pour chauffe eau - variante légère  
Предохранительный клапан для водонагревателей - облегченная версия

Cod./Code	Mis./Size	□/⊞	€
135205001	1/2"	50/200	4,60



## IVR 352 L



Valvola di sicurezza con leva per scaldabagni - tipo leggero  
Safety valve for water heaters - light version  
Sicherheitsventil für Wasserkessel - leichte Ausführung  
Soupape de sécurité pour chauffe eau - variante lourde  
Предохранительный клапан с ручкой флажок для водонагревателей - облегченная версия

Cod./Code	Mis./Size	□/⊞	€
135205002	1/2"	50/200	6,10



## IVR 103



Rubinetto per scarico caldaia serie pesante con quadro di manovra e cappuccio con chiave incorporata - attacco F  
Boiler drain valve heavy pattern with hose connection and cap. F Threaded  
KFE-Hahn (Kessel Füll-und Entleerungshahn) - schwere Ausführung - mit Schalttafel und Deckel - IG - Schlauchanschluss - mit integriertem Schlüssel  
Robinet d'évacuation chaudière série lourde avec tableau de manoeuvre et capuchon à clé intégrée - fixation F  
Усиленный сливной кран для котла, с квадратной управляющей головкой и крышкой со встроенным ключом - резьбовое соединение B

Cod./Code	Mis./Size	Ø	□/⊞	€
110305001	1/2" x 3/4"	10	10/60	13,81
110307001	3/4" x 1"	15	10/60	21,16
110310001	1" x 1"	25	10/40	33,08



## IVR 105



Rubinetto per scarico caldaia serie pesante con quadro di manovra e cappuccio con chiave incorporata - attacco M  
Boiler drain valve heavy pattern with hose connection and cap. M Threaded  
KFE-Hahn (Kessel Füll-und Entleerungshahn) - schwere Ausführung - mit Schalttafel und Deckel - AG - Schlauchanschluss - mit integriertem Schlüssel  
Robinet d'évacuation chaudière série lourde avec tableau de manoeuvre et capuchon à clé intégrée - fixation M  
Усиленный сливной кран для котла, с квадратной управляющей головкой и крышкой со встроенным ключом - резьбовое соединение H

Cod./Code	Mis./Size	Ø	□/⊞	€
110505001	1/2" x 3/4"	10	10/60	14,29
110507001	3/4" x 1"	15	10/60	21,60
110510001	1" x 1"	25	10/40	34,07



## IVR 904



Rubinetto per scarico caldaia completo di tappo - attacchi M - portagomma  
Boiler drain valve with hose connection and cap - M threaded  
KFE-Hahn (Kessel Füll - und Entleerungshahn) mit Deckel - AG - Schlauchanschluss  
Robinet d'évacuation chaudière avec bouchon - fixations M - porte tuyau souple - Poignée noire  
Сливной кран для котла в комплекте с насадкой для шланга и заглушкой, резьбовое соединение H

Cod./Code	Mis./Size	Ø	□/⊕	€
190403001	3/8" x 3/4"	8	40/160	6,28
190405001	1/2" x 3/4"	10	40/160	6,73
190407001	3/4" x 1"	15	20/100	10,16



## IVR 905



Rubinetto per scarico caldaia completo di tappo - attacchi M - con portagomma, anello di tenuta, ghiera e controdado  
Boiler drainage valve with cap - M couplings - with hose adaptor, sealing ring, ring nut and counter-nut  
Kesselablasshahn komplett mit Stopfen - Stecker-Anschlüsse - mit Schlauchanschluss, Dichtring, Ringmutter und Kontermutter  
Robinet pour décharge chaudière avec bouchon - raccords M - avec embout, bague d'étanchéité, collier de serrage et contre-écrou  
Сливной кран для котла с заглушкой в комплекте - соединения M - со штуцером, уплотнительным кольцом, обхватом и контргайкой

Cod./Code	Mis./Size	Ø	□/⊕	€
190505002	1/2" x 3/4"	10	20/100	8,51



## IVR 62



Rubinetto per scarico caldaia serie pesante, con tappo, attacco F  
Heavy pattern boiler drain valve. F threads with plug  
KFE-Hahn schwere Ausführung mit Kappe Anschluss IG  
Robinet d'évacuation chaudière type lourd fixation F et bouchon  
Сливной кран для котла тяжелой серии, с заглушкой, соединение B.

Cod./Code	Mod./Model	Mis./Size	□/⊕	€
106205001	nichelato / nichel	1/2"	10/120	8,36
106205011	giallo / yellow	1/2"	10/120	8,16



## IVR 64



Rubinetto per scarico caldaia serie pesante, con tappo, attacco M  
Heavy pattern boiler drain valve with cap and M connection  
KFE-Hahn mit Kappe - Anschluss AG  
Robinet d'évacuation chaudière type lourd avec bouchon - fixation M  
Сливной кран для котла тяжелой серии, с заглушкой, соединение H.

Cod./Code	Mod./Model	Mis./Size	□/⊕	€
106405001	nichelato / nichel	1/2"	10/120	8,96
106405011	giallo / yellow	1/2"	10/120	8,75





## IVR 149



Rubinetto porta manometro M/F con premistoppa e foro di spurgo, maniglia termoplastica  
Manometer holder M/F with packing nut and drain hole, handle in thermoplastic  
Manometerhalter AG/IG mit Stopfbüchse und Ablassbohrung und Griff aus Thermoplastik  
Robinet porte-manomètre M/F avec presse-étoupe et purge, poignée en thermoplastique  
Кран для установки манометра, соединения Н/В, с сальником, выпускным отверстием, термопластиковая ручка

Cod./Code	Mis./Size	□/田	€
114902001	1/4"	10/120	16,20
114903001	3/8"	10/120	16,69
114905001	1/2"	10/120	18,26



## IVR 150



Rubinetto porta manometro M/F con premistoppa, flangia e tappo su flangia e foro di spurgo, maniglia termoplastica  
Manometer holder M/F with packing nut, flange and cap on the flange, handle in thermoplastic  
Manometerhalter AG/IG mit Stopfbüchse, Flansche und Deckel auf der Flansche, Griff aus Thermoplastik  
Robinet porte-manomètre M/F avec presse-étoupe, bride et bouchon sur la bride, poignée en thermoplastique  
Кран для установки манометра, соединения Н/В, с сальником, выпускным отверстием, фланцем и заглушкой на фланце, термопластиковая ручка

Cod./Code	Mis./Size	□/田	€
115002001	1/4"	10/60	19,84
115003001	3/8"	10/60	20,87
115005001	1/2"	10/60	22,93



## ACCESSORI PER VALVOLE TERMOSTATICHE ACCESSORIES FOR THERMOSTATIC VALVES

## IVR 459



Chiave per sostituire vitone  
Allen key for thermostatic stem replacement  
Montageblock für den Austausch (von Thermostatventil-Innenteilen unter Druck)  
Clef pour changement du mécanisme  
Ключ для замены кран-буксы без слива системы

Cod./Code	□/田	€
145901000	1/6	507,78



## IVR 457



Adattatore per montaggio testa termostatica DNF  
Adapter for mounting DNF thermostatic head  
Adapter für den Thermostatkopf DNF  
Adaptateur pour le montage de la tête thermostatique DNF  
Адаптер для монтажа термостатической головки DNF

Cod./Code	□/田	€
145700500	500	1,25

## IVR 325



Bocchettone telescopico, nichelato  
Telescopic tail piece, nickel-plated  
Anschluss-Stutzen teleskopisch - vernickelt  
Raccord télescopique - nickelé  
Телескопическое соединение, никелированное

Cod./Code	Mis./Size	□/田	€
132503051	3/8" x 1/2"	20/360	2,91
132503061	3/8" x 5/8"	20/360	2,91
132505071	1/2" x 3/4"	10/180	4,43
132507101	3/4" x 1"	5/100	7,27



## RICAMBI PER LINEA RISCALDAMENTO SPARE PARTS FOR HEATING LINE

### IVR 332



Termostato di sicurezza  
Safety thermostat  
Sicherheitsthermostat  
Thermostat de sécurité  
Предохранительный термостат

Cod./Code	Mod./Model	Mis./Size	□/田	€
133205640	T max 40°C	1/2"	8/120	41,52
133205650	T max 50°C	1/2"	8/120	42,99

### IVR 829



Misuratore di portata in ottone  
Flow meter in brass  
Durchflussmesser aus Messing  
Mesureur de débit en laiton  
Расходомер из латуни

Cod./Code	□/田	€
182900005	15/60	9,73



### IVR 458



Vitone per valvola termostatica  
TRV stem  
Einsatz für Thermostatventil im Verteiler  
Mécanisme pour robinetterie thermostatizable  
Вставка для термостатического клапана

Cod./Code	Mod./Model	Mis./Size	□/田	€
145800020	Per/For AVANT-FLOOR	1"	50/300	5,97
145800115	Per/For SATURN prereg/preset	3/8" x 1/2"	50/600	3,82
145800117	Per/For SATURN prereg/preset	3/4"	50/600	4,32
145800165	Per/For SATURN preset flusso inv./reverse flow	3/8" x 1/2"	50/600	6,38
145800167	Per/For SATURN preset flusso inv./reverse flow	3/4"	50/600	7,24

### IVR 324



Bocchettone per Saturn e Mercury - Con autotenuta  
Tail piece for Saturn and Mercury valves - with auto-seal  
Rohrverschraubung für Saturn und Mercury - mit Selbstdichtung  
Raccord pour Saturn et Mercury - avec autoétanche  
Патрубок для моделей Saturn и Mercury - с самогерметизацией

Cod./Code	Mis./Size	□/田	€
132403051	3/8" x 1/2"	20/240	2,73
132405071	1/2" x 3/4"	20/240	3,49
132407101	3/4" x 1"	10/120	5,57



### IVR 326



Bocchettone per Saturn e Mercury senza autotenuta - (codolo + calotta)  
Tail piece for Saturn and Mercury valves with auto-seal (tail piece and nut)  
Rohrverschraubung für Saturn und Mercury mit Selbstdichtung (Verschraubung und Nuss)  
Raccord pour Saturn et Mercury avec autoétanche (queue et calotte)  
Патрубок без самогерметизации для моделей Saturn и Mercury (хвостовая часть с гайкой).

Cod./Code	Mis./Size	□/田	€
132603051	3/8" x 1/2"	10/120	2,64
132605071	1/2" x 3/4"	20/240	3,23
132607101	3/4" x 1"	10/120	4,55
132610121	1" x 1 1/4"	10/60	7,49



## IVR 594



Volantino manuale. ABS colore RAL 9010 - per SATURN, AVANT FLOOR, IVR INOX  
Manual handle. ABS Ral 9010 colour - for SATURN, AVANT FLOOR, IVR INOX  
ABS Handrad, RAL9010 - für SATURN, AVANT FLOOR, IVR INOX  
Volant manuel ABS couleur RAL 9010 - pour SATURN, AVANT FLOOR, IVR INOX  
Колпачок для ручной регулировки, ABS цвет Ral 9010 - для SATURN, AVANT FLOOR, IVR INOX.

Cod./Code	□/⊞	€
159400001	10/120	2,19

## IVR 596



Cappello di regolazione per SATURN, AVANT FLOOR, IVR INOX - ABS Colore RAL 9010  
Operating plastic cap for SATURN, AVANT FLOOR, IVR INOX - ABS Ral 9010 colour  
ABS Einstellkappe für SATURN, AVANT FLOOR, IVR INOX - RAL 9010  
Chapeau de réglage pour SATURN, AVANT FLOOR, IVR INOX - ABS Couleur RAL 9010  
Регулирующий колпачок для SATURN, AVANT FLOOR, IVR INOX - ABS цвет Ral 9010

Cod./Code	Att./Conn.	□/⊞	€
159600001	M30 x 1,5	50/300	0,62

## IVR 588



Cappuccio per detentori JUPITER - ABS colore RAL 9010  
Plug for lockshield JUPITER - ABS colour Ral 9010  
Kappe für Rücklaufverschraubungen JUPITER - ABS RAL 9010  
Capuchon pour coudes de réglages JUPITER - ABS couleur RAL 9010  
Колпачок для отсекающего клапана JUPITER - ABS цвет RAL 9010

Cod./Code	Mis./Size	□/⊞	€
158803001	3/8"	10/180	0,75
158805001	1/2"	10/180	0,82
158807001	3/4"	10/120	0,87

## IVR 590



Volantino manuale ABS colore RAL 9010 - per MERCURY, AVANT FLOOR  
ABS manual handle Ral 9010 colour - for MERCURY, AVANT FLOOR  
ABS Handrad, RAL9010 - für MERCURY, AVANT FLOOR  
Volant manuel ABS couleur RAL 9010 - pour MERCURY, AVANT FLOOR  
Колпачок для ручной регулировки, ABS цвет Ral 9010 - для MERCURY, AVANT FLOOR

Cod./Code	Mis./Size	□/⊞	€
159000002	3/8" - 1/2"	10/180	1,12

## IVR 586



Cappuccio per detentori MERCURY - MERCURY PLUS - ottone nichelato  
Cap for MERCURY lockshield - MERCURY PLUS - nickel-plated brass  
Kappe für Rücklaufverschraubungen MERCURY - MERCURY PLUS - aus vernickeltem Messing  
Capuchon pour coude de réglage MERCURY - MERCURY PLUS - en laiton nickelé  
Заглушка для отсекающего клапана MERCURY - MERCURY PLUS - из латуни, никелированная.

Cod./Code	Mis./Size	□/⊞	€
158600001	3/8" - 1/2"	10/180	0,94

## IVR 587



Cappuccio per detentori MERCURY - ABS colore RAL 9010  
Cap for lockshield MERCURY - ABS colour Ral 9010  
Kappe für Rücklaufverschraubungen MERCURY - ABS RAL 9010  
Capuchon pour coudes de réglage MERCURY - ABS couleur RAL 9010  
Колпачок для отсекающего клапана MERCURY - ABS цвет Ral 9010

Cod./Code	Mis./Size	□/⊞	€
158700001	3/8" - 1/2"	10/180	0,75

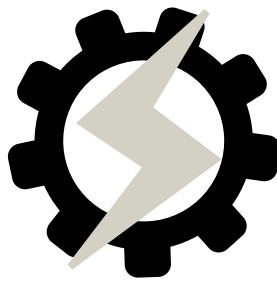

**SERVOCOMANDI E VALVOLE MOTORIZZABILI**  
ACTUATORS AND MOTORIZED VALVES  
SERVOSTEUERUNGEN UND MOTORISIERBARE KUGELHÄHNE  
SERVOCOMMANDES ET VANNES MOTORISABLES  
ЭЛЕКТРИЧЕСКИЕ И ПНЕВМАТИЧЕСКИЕ ПРИВОДЫ



<b>COMPACT MOTOR + MOTORHEAD</b>	<b>p. 92</b>
<b>COMPACT MOTOR</b>	<b>p. 96</b>
<b>MOTORHEAD</b>	<b>p. 99</b>
<b>COMPACT MOTOR DRINKING WATER</b>	<b>p. 101</b>
<b>AUTOMAT MIX + MOTORHEAD MIX</b>	<b>p. 103</b>
<b>AUTOMAT MIX</b>	<b>p. 104</b>
<b>MOTORHEAD MIX / UNIMIX</b>	<b>p. 104</b>
<b>AUTOMAT DIV + MOTORHEAD DIV</b>	<b>p. 105</b>
<b>AUTOMAT DIV</b>	<b>p. 105</b>
<b>MOTORHEAD DIV / UNI DIV</b>	<b>p. 105</b>
<b>AUTOMAT MIX EASY + MOTORHEAD MIX EASY</b>	<b>p. 106</b>
<b>AUTOMAT MIX EASY</b>	<b>p. 106</b>
<b>MOTORHEAD MIX EASY</b>	<b>p. 107</b>
<b>AUTOMAT DIV EASY + MOTORHEAD DIV EASY</b>	<b>p. 107</b>
<b>AUTOMAT DIV EASY</b>	<b>p. 107</b>
<b>MOTORHEAD DIV EASY</b>	<b>p. 108</b>
<b>ACCESSORI PER LINEA VALVOLE MOTORIZZATE</b> <b>ACCESSORIES FOR MOTORIZED VALVES LINE</b>	<b>p. 108</b>





COMPACT MOTOR + MOTORHEAD



AUTOMAT L + MOTORHEAD ISO



COMPACT MOTOR



AUTOMAT L



MOTORHEAD



MOTORHEAD ISO

**2 VIE/WAY**

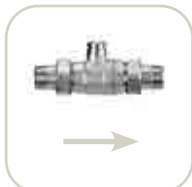

F/F IVR 220  
 M/F IVR 221  
 M/M IVR 222  
 C/C IVR 223

**3 VIE/WAY D**



F/F/F IVR 234  
 F/F/M IVR 235  
 M/F/M IVR 236  
 M/M/M IVR 237

**3 VIE/WAY BP**



F/F/M IVR 240  
 M/F/M IVR 241  
 M/M/M IVR 242

**2 VIE/WAY**



F/F IVR 230

**UNI-BI DIREZIONALE/ONE-BI DIRECTIONAL**



IVR 215

- Relè (2 Pt./Cnt.)  
 - NO Relè (3 Pt./Cnt.)

Con/With 1 AUX Microswitch



IVR 215

- Relè (2 Pt./Cnt.)  
 - NO Relè (3 Pt./Cnt.)

Con/With 1 AUX Microswitch

**BI DIREZIONALE/BI DIRECTIONAL**



IVR 217

- NO Relè (3 Pt./Cnt.)

Con/With 1 AUX Microswitch

## COMPACT MOTOR + MOTORHEAD

### IVR 220 + IVR 215



IVR 220 Compact Motor, valvola di zona a 2 vie, attacchi F/F + IVR 215 Motorhead uni-bidirezionale 230 V. con relé a 2 punti, 1 micro supplementare

IVR 220 Compact Motor, 2-way zone valve, threaded ends F/F + IVR 215 uni-/bidirectional Motorhead 230 V with relay, 2 contact terminals, 1 auxiliary microswitch

IVR 220 Compact Motor, 2-Wege-Zonenventil, IG/IG + IVR 215 Motorhead, uni-bidirektional 230 V, mit Relais, mit 2-Punkt-Steuerung und einem zusätzlichen Mikroschalter

IVR 220 Compact Motor, vanne de zone à 2 voies, fixations F/F + IVR 215 Motorhead uni-bidirectionnel 230 V avec relais, 2 points, 1 micro supplémentaire

IVR 220 Compact Motor, двухходовой клапан, соединения В/В + IVR 215 Motorhead одно-двухнаправленный 230 V, 2 контактных зажима с реле, 1 вспомогательный микровыключатель.

Cod./Code	Mis./Size	□/田	€
422005106	1/2"	1/4	125,63
422007106	3/4"	1/4	130,24
422010106	1"	1/4	139,09
422012106	1 1/4"	1/4	145,11



### IVR 230 + IVR 217



IVR 230 Automat L, valvola di zona a 2 vie, flangia ISO 5211, attacchi F/F + IVR 217 Motorhead, bidirezionale 230 V. 3 punti

IVR 230 Automat L, 2-way zone valve, ISO 5211 flange, threaded ends F/F + IVR 217 Motorhead, bidirectional 230 V, 3 contact terminals

IVR 230 Automat L, 2-Wege-Zonenventil, mit Flansch ISO 5211, IG/IG + IVR 217 Motorhead, bidirektional 230 V 3-Punkt-Steuerung

IVR 230 Automat L, vanne de zone à 2 voies, avec la bride ISO 5211, fixations F/F + IVR 217 Motorhead, bidirectionnelle 230V, 3 points

IVR 230 Automat L, двухходовой клапан, фланец ISO 5211, соединения В/В + IVR 217 Motorhead, двухнаправленный 230 V, 3 контактных зажима.

Cod./Code	Mis./Size	□/田	€
423015218	1 1/2"	1/4	267,54
423020218	2"	1/4	287,31



### IVR 221 + IVR 215



IVR 221 Compact Motor, valvola di zona a 2 vie, attacchi M/F + IVR 215 Motorhead uni-bidirezionale 230 V. con relé a 2 punti, 1 micro supplementare

IVR 221 Compact Motor, 2-way zone valve, threaded ends M/F + IVR 215 uni-/bidirectional Motorhead 230 V with relay, 2 contact terminals, 1 auxiliary microswitch

IVR 221 Compact Motor 220, 2-Wege-Zonenventil, AG/IG + IVR 215 Motorhead, uni-bidirektional 230 V, mit Relais, mit 2-Punkt-Steuerung und einem zusätzlichen Mikroschalter

IVR 221 Compact Motor, vanne de zone à 2 voies, fixations M/F + IVR 215 Motorhead uni-bidirectionnel 230 V avec relais, 2 points, 1 micro supplémentaire

IVR 221 Compact Motor, двухходовой клапан, соединения Н/В + IVR 215 Motorhead одно-двухнаправленный 230 V, 2 контактных зажима с реле, 1 вспомогательный микровыключатель.

Cod./Code	Mis./Size	□/田	€
422105106	1/2"	1/4	128,84
422107106	3/4"	1/4	134,41
422110106	1"	1/4	145,05
422112106	1 1/4"	1/4	153,91



## IVR 222 + IVR 215



**ERC**

IVR 222 Compact Motor, valvola di zona a 2 vie, attacchi M/M + IVR 215 Motorhead uni-bidirezionale 230 V. con relé a 2 punti, 1 micro supplementare

IVR 222 Compact Motor, 2-way zone valve, threaded ends M/M + IVR 215 uni-/bidirectional Motorhead 230 V with relay, 2 contact terminals, 1 auxiliary microswitch

IVR 222 Compact Motor, 2-Wege-Zonenventil, AG/AG + IVR 215 Motorhead, uni-bidirektional 230 V, mit Relais, mit 2-Punkt-Steuerung und einem zusätzlichen Mikroschalter

IVR 222 Compact Motor, vanne de zone à 2 voies, fixations M/M + IVR 215 Motorhead uni-bidirectionnel 230 V avec relais, 2 points, 1 micro supplémentaire

IVR 222 Compact Motor, двухходовой клапан, соединения Н/Н + IVR 215 Motorhead одно-двунаправленный 230 V, 2 контактных зажима с реле, 1 вспомогательный микровыключатель.

Cod./Code	Mis./Size	□/田	€
422205106	1/2"	1/4	132,09
422207106	3/4"	1/4	138,86
422210106	1"	1/4	151,89
422212106	1"1/4	1/4	164,11



## IVR 223 + IVR 215



**ERC**

IVR 223 Compact Motor, valvola di zona a 2 vie, attacchi tubo rame a compressione C/C + Motorhead 215 uni-bidirezionale 230 V. con relé a 2 punti, 1 micro supplementare

IVR 223 Compact Motor, 2-way zone valve, copper compression ends for copper pipe CxC + IVR 215 uni-/bidirectional Motorhead 230 V with relay, 2 contact terminals, 1 auxiliary microswitch

IVR 223 Compact Motor, 2-Wege-Zonenventil, Kompressionanschlüsse für Kupferrohr + IVR 215 Motorhead, uni-bidirektional 230 V, mit Relais, mit 2-Punkt-Steuerung und einem zusätzlichen Mikroschalter

IVR 223 Compact Motor, vanne de zone à 2 voies, fixations tube cuivre à compression + IVR 215 Motorhead uni-bidirectionnel 230 V avec relais, 2 points, 1 micro supplémentaire

IVR 223 Compact Motor, двухходовой клапан, компрессионные соединения для медной трубы + 215 Motorhead одно-двунаправленный 230 V, 2 контактных зажима с реле, 1 вспомогательный микровыключатель.

Cod./Code	DN	Ø	□/田	€
422315106	15	15	1/4	127,60
422322106	22	20	1/4	133,29
422328106	28	25	1/4	142,40



## IVR 235 + IVR 215



**ERC**

IVR 235 Compact Motor, valvola di zona a 3 vie deviatrice, attacchi F/F/M + IVR 215 Motorhead uni-bidirezionale 230 V. con relé a 2 punti, 1 micro supplementare

IVR 235 Compact Motor 3-way diverting zone valve, threaded ends F/F/M + IVR 215 uni-/bidirectional Motorhead 230 V with relay, 2 contact terminals, 1 auxiliary microswitch

IVR 235 Compact Motor, 3-Wege-Ableitzonenventil, IG/IG/AG + IVR 215 Motorhead, uni-bidirektional 230 V, mit Relais, mit 2-Punkt-Steuerung und einem zusätzlichen Mikroschalter

IVR 235 Compact Motor, vanne de zone déviatrice à 3 voies, fixations F/F/M + IVR 215 Motorhead uni-bidirectionnel 230 V avec relais, 2 points, 1 micro supplémentaire

IVR 235 Compact Motor, отводной шаровой клапан, трёхходовой, соединения В/В/Н + IVR 215 Motorhead одно-двунаправленный 230 V, 2 контактных зажима с реле, 1 вспомогательный микровыключатель.

Cod./Code	Mis./Size	□/田	€
423507112	3/4"	1/4	142,66
423510112	1"	1/4	155,47



## IVR 234 + IVR 215



IVR 234 Compact Motor, valvola di zona a 3 vie deviatrice, attacchi F/F/F + IVR 215 Motorhead uni-bidirezionale 230 V. con relé a 2 punti, 1 micro supplementare

IVR 234 Compact Motor 3-way diverting zone valve, threaded ends F/F/F + IVR 215 uni-/bidirectional Motorhead 230 V with relay, 2 contact terminals, 1 auxiliary microswitch

IVR 234 Compact Motor, 3-Wege-Ableitzoneventil, IG/IG/IG + IVR 215 Motorhead, uni-bidirektional 230 V, mit Relais, mit 2-Punkt-Steuerung und einem zusätzlichen Mikroschalter

IVR 234 Compact Motor, vanne de zone déviatrice à 3 voies, fixations F/F/F + IVR 215 Motorhead uni-bidirectionnel 230 V avec relais, 2 points, 1 micro supplémentaire

IVR 234 Compact Motor, отводной шаровой клапан, трёхходовой, соединения В/В/В + IVR 215 Motorhead одно-двунаправленный 230 V, 2 контактных зажима с реле ,1 вспомогательный микровыключатель.

Cod./Code	Mis./Size	□/田	€
423407112	3/4"	1/4	134,62
423410112	1"	1/4	141,46



## IVR 236 + IVR 215



ERC

IVR 236 Compact Motor, valvola di zona a 3 vie deviatrice, attacchi M/F/M + IVR 215 Motorhead uni-bidirezionale 230 V. con relé a 2 punti, 1 micro supplementare

IVR 236 Compact Motor, 3-way diverting zone valve, threaded ends M/F/M + IVR 215 Motorhead uni-/bidirectional 230 V with relay, 2 contact terminals, 1 microswitch

IVR 236 Compact Motor, 3-Wege-Ableitzoneventil, AG/IG/AG + IVR 215 Motorhead, uni-bidirektional 230 V, mit Relais, mit 2-Punkt-Steuerung und einem zusätzlichen Mikroschalter

IVR 236 Compact Motor, vanne de zone déviatrice à 3 voies, fixations M/F/M + IVR 215 Motorhead uni-bidirectionnel 230 V avec relais, 2 points, 1 micro supplémentaire

IVR 236 Compact Motor, отводной шаровой клапан, трёхходовой, соединения Н/В/Н + IVR 215 Motorhead одно - двунаправленный 230 V, 2 контактных зажима с реле, 1 вспомогательный микровыключатель.

Cod./Code	Mis./Size	□/田	€
423607112	3/4"	1/4	146,74
423610112	1"	1/4	161,67



## IVR 237 + IVR 215



ERC

IVR 237 Compact Motor, valvola di zona a 3 vie deviatrice, attacchi M/M/M + IVR 215 Motorhead uni-bidirezionale 230 V. con relé a 2 punti, 1 micro supplementare

IVR 237 Compact Motor, 3-way diverting zone valve, threaded ends M/M/M + IVR 215 Motorhead uni-/bidirectional 230 V with relay, 2 contact terminals, 1 microswitch

IVR 237 Compact Motor, 3-Wege-Ableitzoneventil, AG/AG/AG + IVR 215 Motorhead, uni-bidirektional 230 V, mit Relais, mit 2-Punkt-Steuerung und einem zusätzlichen Mikroschalter

IVR 237 Compact Motor, vanne de zone déviatrice à 3 voies, fixations M/M/M + IVR 215 Motorhead uni-bidirectionnel 230 V avec relais, 2 points, 1 micro supplémentaire

IVR 237 Compact Motor, отводной шаровой клапан, трёхходовой, соединения Н/Н/Н + IVR 215 Motorhead одно-двунаправленный 230 V - 2 контактных зажима с реле, 1 вспомогательный микровыключатель.

Cod./Code	Mis./Size	□/田	€
423707112	3/4"	1/4	151,10
423710112	1"	1/4	168,56



## IVR 240 + IVR 215



**ERC**

IVR 240 Compact Motor, valvola a sfera a passaggio totale, con by-pass, motorizzabile, attacchi F/F/M + IVR 215 Motorhead uni-bidirezionale 230 V. con relé a 2 punti, 1 micro supplementare

IVR 240 Compact Motor, full bore ball valve for actuators, with by-pass, threaded ends F/F/M + IVR 215 Motorhead uni-/bidirectional 230 V with relay, 2 contact terminals, 1 auxiliary microswitch

IVR 240 Compact Motor, motorisierbares Kugelventil mit vollem Durchgang, mit Bypass, IG/IG/AG + IVR 215 Motorhead, uni-bidirektional 230 V, mit Relais, mit 2-Punkt-Steuerung und einem zusätzlichen Mikroschalter

IVR 240 Compact Motor, vanne à boisseau sphérique à passage intégral, avec by-pass, motorisable, fixations F/F/M + IVR 215 Motorhead uni-bidirectionnel 230 V avec relais, 2 points, 1 micro supplémentaire

IVR 240 Compact Motor, полнопроходной шаровой кран для привода, с бай-пассом, соединения В/В/Н + IVR 215 Motorhead одно-двухнаправленный 230 V, 2 контактных зажима с реле, 1 вспомогательный микровыключатель

Cod./Code	Mis./Size	□/田	€
424007112	3/4"	1/4	146,74
424010112	1"	1/4	164,88



## IVR 241 + IVR 215



**ERC**

IVR 241 Compact Motor, valvola a sfera a passaggio totale, con by-pass, motorizzabile, attacchi M/F/M + IVR 215 Motorhead uni-bidirezionale 230 V. con relé a 2 punti, 1 micro supplementare

IVR 241 Compact Motor, full bore ball valve for actuators with by-pass, threaded ends M/F/M + IVR 215 uni-/bidirectional 230 V with relay, 2 contact terminals, 1 auxiliary microswitch

IVR 241 Compact Motor, motorisierbares Kugelventil mit vollem Durchgang, mit Bypass, AG/IG/AG + IVR 215 Motorhead, uni-bidirektional 230 V, mit Relais, mit 2-Punkt-Steuerung und einem zusätzlichen Mikroschalter

IVR 241 Compact Motor, vanne à boisseau sphérique à passage intégral, avec by-pass, motorisable, fixations M/F/M + IVR 215 Motorhead uni-bidirectionnel 230 V avec relais, 2 points, 1 micro supplémentaire

IVR 241 Compact Motor, полнопроходной шаровой кран для привода, с бай-пасс, соединения Н/В/Н + IVR 215 Motorhead одно-двухнаправленный 230 V, 2 контактных зажима с реле, 1 вспомогательный микровыключатель

Cod./Code	Mis./Size	□/田	€
424107112	3/4"	1/4	142,29
424110112	1"	1/4	157,97



## IVR 242 + IVR 215



**ERC**

IVR 242 Compact Motor, valvola a sfera a passaggio totale, con by-pass, motorizzabile, attacchi M/M/M + IVR 215 Motorhead uni-bidirezionale 230 V. con relé a 2 punti, 1 micro supplementare

IVR 242 Compact Motor, full bore ball valve for actuators with by-pass, threaded ends M/M/M + IVR 215 uni-/bidirectional 230 V with relay, 2 contact terminals, 1 auxiliary microswitch

IVR 242 Compact Motor, motorisierbares Kugelhahn mit vollem Durchgang, mit Bypass, AG/AG/AG + IVR 215 Motorhead, uni-bidirektional 230 V, mit Relais, mit 2-Punkt-Steuerung und einem zusätzlichen Mikroschalter

IVR 242 Compact Motor, vanne à boisseau sphérique à passage intégral, avec by-pass, motorisable, fixations M/M/M + IVR 215 Motorhead uni-bidirectionnel 230 V avec relais, 2 points, 1 micro supplémentaire

IVR 242 Compact Motor, полнопроходной шаровой кран для привода, с бай-пасс, соединения Н/Н/Н + IVR 215 Motorhead одно-двухнаправленный 230 V, 2 контактных зажима с реле, 1 вспомогательный микровыключатель

Cod./Code	Mis./Size	□/田	€
424207112	3/4"	1/4	146,70
424210112	1"	1/4	164,73



## COMPACT MOTOR

### IVR 220



Valvola a sfera a passaggio totale motorizzabile, 2 vie, attacchi F/F  
2-way full bore ball valve for actuators, F/F  
2-Wege-Kugelhahn, motorisierbar, mit vollem Durchgang, IG/IG  
Vanne à boisseau sphérique à passage intégral à 2 voies, motorisable, fixations F/F  
Полнопроходной двухходовой шаровой кран для привода, соединения В/В.

Cod./Code	Mis./Size	Ø	□/⊕	€
122005010	1/2"	15	1/18	15,89
122007010	3/4"	20	1/18	20,49
122010010	1"	25	1/18	29,34
122012010	1"1/4	32	1/18	35,37



### IVR 230



Valvola a sfera a passaggio totale, 2 vie, motorizzabile, con flangia ISO 5211, attacchi F/F  
2-way full bore ball valve for actuators, with ISO 5211 flange, threaded ends F/F  
2-Wege-Kugelhahn mit vollem Durchgang, motorisierbar, mit Flansch ISO 5211, IG/IG  
Vanne à boisseau sphérique à passage intégral à 2 voies, motorisable, avec la bride ISO 5211, fixations F/F  
Полнопроходной шаровой кран для привода, с двухходовым клапаном, фланец ISO 5211, соединения В/В.

Cod./Code	Mis./Size	ISO	□/⊕	€
123015001	1"1/2	F04	4/16	62,03
123020001	2"	F04	4/16	81,82



### IVR 221



Valvola a sfera a passaggio totale motorizzabile, 2 vie, attacchi M/F  
2-way full bore ball valve for actuators, threaded ends M/F  
2-Wege-Kugelhahn, motorisierbar, mit vollem Durchgang, AG/IG  
Vanne à boisseau sphérique à passage intégral à 2 voies, motorisable, fixations M/F  
Полнопроходной двухходовой шаровой кран для привода, соединения Н/В.

Cod./Code	Mis./Size	Ø	□/⊕	€
122105010	1/2"	15	1/18	19,10
122107010	3/4"	20	1/18	24,66
122110010	1"	25	1/18	35,31
122112010	1"1/4	32	1/18	44,17



### IVR 222



Valvola a sfera a passaggio totale motorizzabile, 2 vie, attacchi M/M  
2-way full bore ball valve for actuators, M/M  
2-Wege-Kugelhahn, motorisierbar, mit vollem Durchgang, AG/AG  
Vanne à boisseau sphérique à passage intégral à 2 voies, motorisable, fixations M/M  
Полнопроходной двухходовой шаровой кран для привода, соединения Н/Н.

Cod./Code	Mis./Size	Ø	□/⊕	€
122205010	1/2"	15	1/18	22,36
122207010	3/4"	20	1/18	29,12
122210010	1"	25	1/15	42,15
122212010	1"1/4	32	1/15	54,38





## IVR 223



Valvola a sfera a passaggio totale motorizzabile, 2 vie, attacchi tubo rame a compressione C/C  
 2-way full bore ball valve for actuators, compression ends for copper pipe CxC  
 2-Wege-Kugelhahn, motorisierbar, mit vollem Durchgang, Kompressionsanschlüsse für Kupferrohr  
 Vanne à boisseau sphérique à passage intégral, motorisable, fixations tube cuivre à compression  
 Полнопроходной двухходовой шаровой кран для привода, соединения - компрессионные, для медной трубы

Cod./Code	Mis./Size	DN	□/田	€
122315010	1/2"	15	1/18	17,90
122322010	3/4"	22	1/18	23,54
122328010	1"	28	1/18	32,65



## IVR 235



Valvola a sfera a passaggio totale, 3 vie deviatrice, motorizzabile, attacchi F/F/M  
 3-way diverting full bore ball valve for actuators, threaded ends F/F/M  
 3-Wege-Ableitzonenventil, motorisierbar, IG/IG/AG  
 Vanne à boisseau sphérique à passage intégral déviatrice à 3 voies, motorisable, fixations F/F/M  
 Полнопроходной отводной шаровой клапан для привода, трёхходовой, соединения В/В/Н

Cod./Code	Mis./Size	Ø	□/田	€
123507010	3/4"	20	1/18	32,91
123510010	1"	25	1/15	45,71



## IVR 234



Valvola a sfera a passaggio totale, 3 vie deviatrice, motorizzabile, attacchi F/F/F  
 3-way diverting full bore ball valve for actuators, threaded ends F/F/F  
 3-Wege-Ableitzonenventil, motorisierbar, IG/IG/IG  
 Vanne à boisseau sphérique à passage intégral déviatrice à 3 voies, motorisable, fixations F/F/F  
 Полнопроходной отводной шаровой кран для привода, трёхходовой, соединения В/В/В

Cod./Code	Mis./Size	Ø	□/田	€
123407010	3/4"	20	1/18	28,11
123410010	1"	25	1/15	35,19



## IVR 236



Valvola a sfera a passaggio totale, 3 vie deviatrice, motorizzabile, attacchi M/F/M  
 3-way diverting full bore ball valve for actuators, threaded ends M/F/M  
 3-Wege-Ableitzonenventil, motorisierbar, AG/IG/AG  
 Vanne à boisseau sphérique à passage intégral déviatrice à 3 voies, motorisable, fixations M/F/M  
 Полнопроходной отводной шаровой клапан для привода, трёхходовой, соединения Н/В/Н

Cod./Code	Mis./Size	Ø	□/田	€
123607010	3/4"	20	1/15	36,99
123610010	1"	25	1/15	51,93



## IVR 237



Valvola a sfera a passaggio totale, 3 vie deviatrice, motorizzabile, attacchi M/M/M

3-way diverting full bore ball valve for actuators, threaded ends M/M/M

3-Wege-Ableitzoneventil, motorisierbar, AG/AG/AG

Vanne à boisseau sphérique à passage intégral déviatrice à 3 voies, motorisable, fixations M/M/M

Полнопроходной отводной шаровой клапан для привода, трёхходовой, соединения Н/Н/Н

Cod./Code	Mis./Size	Ø	□/⊕	€
123707010	3/4"	20	1/15	41,35
123710010	1"	25	1/15	58,93



## IVR 240



Valvola a sfera a passaggio totale, con by-pass, motorizzabile, attacchi F/F/M

Full bore ball valve for actuators with by-pass, threaded ends F/F/M

Kugelhahn mit vollem Durchgang, mit Bypass, motorisierbar, IG/IG/AG

Vanne à boisseau sphérique à passage intégral, avec by-pass, motorisable, fixations F/F/M

Полнопроходной шаровой кран для привода, с бай-пассом, соединения В/В/

Cod./Code	Mis./Size	Ø	□/⊕	€
124007010	3/4"	20	1/18	36,99
124010010	1"	25	1/15	55,14



## IVR 241



Valvola a sfera a passaggio totale, 3 vie con by-pass, motorizzabile, attacchi M/F/M

Full bore ball valve for actuators with by-pass, threaded ends M/F/M

3-Wege-Kugelhahn mit vollem Durchgang mit Bypass, motorisierbar, AG/IG/AG

Vanne à boisseau sphérique à passage intégral à 3 voies, avec by-pass, motorisable, fixations M/F/M

Полнопроходной шаровой кран для привода, трёхходовой, с бай-пассом, соединения Н/Н/Н

Cod./Code	Mis./Size	Ø	□/⊕	€
124107010	3/4"	20	1/15	32,55
124110010	1"	25	1/15	48,23



## IVR 242



Valvola a sfera a passaggio totale, 3 vie con by-pass, motorizzabile, attacchi M/M/M

3-way full bore ball valve for actuators with by-pass, threaded ends M/M/M

3-Wege-Kugelhahn mit vollem Durchgang mit Bypass, motorisierbar, AG/AG/AG

Vanne à boisseau sphérique à passage intégral à 3 voies, avec by-pass, motorisable, fixations M/M/M

Полнопроходной шаровой кран для привода, трёхходовой, с бай-пассом, соединения Н/Н/Н

Cod./Code	Mis./Size	Ø	□/⊕	€
124207010	3/4"	20	1/15	36,95
124210010	1"	25	1/15	55,08



## MOTORHEAD

### IVR 215 UB



IVR 215 Motorehad servocomando per valvole serie COMPACT MOTOR uni-bidirezionale (on-off), comando a 2 punti con relè, 1 micro supplementare libero in apertura di serie

IVR 215 MOTORHEAD actuator for the valve series COMPACT MOTOR uni-/bidirectional (on-off), 2 contact terminals with relay, 1 auxiliary microswitch included, free on opening

IVR 215 Motorhead für die Serie COMPACT MOTOR, uni-bidirektional (On-Off), 2-Punkt-Steuerung mit Relais, mit einem zusätzlichen Mikroschalter beim Öffnen zugestattet

IVR 215 Motorhead servocommande pour les vannes COMPACT MOTOR, uni-bidirectionnelle (on-off), 2 points, avec relais, 1 micro-interrupteur supplémentaire inclus, libre en ouverture

IVR 215 Motorhead сервопривод для клапанов серии COMPACT MOTOR, одно-двухнаправленный (on-off), 2 контактных зажима с реле ,1 вспомогательный микровыключатель свободный для подключения.

Cod./Code	Mod./Model	□/⊕	€
121518041	24V - 8Nm 45 sec.	1/15	108,32
121538041	230V - 8Nm 45 sec.	1/15	108,32



### IVR 215 B



IVR 215 Motorhead servocomando per valvole serie "COMPACT MOTOR" bidirezionale, comando a 3 punti, 1 micro supplementare libero in apertura di serie

IVR 215 Motorhead actuator for the series "COMPACT MOTOR" bidirectional, 3 contact terminals, 1 auxiliary microswitch included, free on opening

IVR 215 Motorhead für die Serie "COMPACT MOTOR", uni-bidirektional, 3-Punkt-Steuerung mit Relais, mit einem zusätzlichen Mikroschalter beim Öffnen zugestattet

IVR 215 Motorhead servocommande pour les vannes "COMPACT MOTOR", uni-bidirectionnelle, 3 points, avec relais, 1 micro-interrupteur supplémentaire inclus, libre en position d'ouverture

IVR 215 Motorhead сервопривод для клапанов серии "COMPACT MOTOR", двухнаправленный, 3 контактных зажима , 1 вспомогательный микровыключатель свободный для подключения.

Cod./Code	Mod./Model	□/⊕	€
121518020	24V - 8Nm 35 sec.	1/15	134,65
121538020	230V - 8Nm 35 sec.	1/15	132,58



### IVR 217 3P



IVR 217 Motorhead ISO 5211, per valvole serie Automat L, bidirezionale, comando a 3, 1 micro supplementare libero in apertura di serie

IVR 217 Motorhead ISO 5211 for Automat L valves, bidirectional, 3 contact terminals, 1 auxiliary microswitch included, free on opening

IVR 217 Motorhead ISO 5211, für die Kugelventile der Serie Automat L, bidirektional, mit 3-Punkt-Steuerung und mit einem zusätzlichen Mikroschalter beim Öffnen zugestattet

IVR 217 Motorhead ISO 5211 pour les vannes Automat L, bidirectionnelle, 3 points, 1 micro-interrupteur inclus libre en position d'ouverture

IVR 217 Motorhead ISO 5211 для кранов серии Automat L, двухнаправленный, 3 контактных зажима, 1 вспомогательный микровыключатель свободный для подключения.

Cod./Code	Mod./Model	ISO	□/⊕	€
121743520	230V - 14Nm 35 sec. - 2 contact	F04	1/10	204,03



## COMPACT MOTOR DRINKING WATER

**IVR 220 G**



**IVR 234 G**



---

**IVR 215 DIV EASY G**



## COMPACT MOTOR DRINKING WATER

### IVR 220 G

NEW



Valvola a sfera a passaggio totale motorizzabile, 2 vie, attacchi F/F - versione in ottone NON nichelata  
 Full bore ball valve for actuator, 2-way, F/F couplings - version in brass NOT nickel-plated  
 2 Wege motorisierbarer Kugelhahn mit vollem Durchgang, IG/IG-Anschlüsse - Messing Version NICHT vernickelt  
 Vanne à bille à passage total motorisable, 2 voies, raccords F/F - version en laiton NON nickelée  
 Полнопроходной двухходовой шаровой кран для привода, соединения В/В - без никелированного покрытия

Cod./Code	Mis./Size	□/田	€
122005175	1/2"	20	17,23
122007175	3/4"	20	20,79
122010175	1"	20	27,05
122012175	1"1/4	16	34,88



### IVR 234 G

NEW



Valvola a sfera a passaggio totale, 3 vie deviatrice, motorizzabile, attacchi F/F/F - versione in ottone NON nichelata  
 Full bore ball valve for actuator, 3-way, diverter, F/F/F couplings - version in brass NOT nickel-plated  
 3 Wege motorisierbarer Kugelhahn mit vollem Durchgang, IG/IG/IG - Messing Version NICHT vernickelt  
 Vanne à bille à passage total, 3 voies de dérivation, motorisable, raccords F/F - version en laiton NON nickelée  
 Полнопроходной отводной шаровой клапан для привода, трёхходовой, соединения В/В/В - без никелированного покрытия

Cod./Code	Mis./Size	□/田	€
123407175	3/4"	20	30,02
123410175	1"	12	38,35
123412175	1"1/4	8	59,26



### IVR 215 DIV EASY G

NEW



Servocomando per valvole deviatrici IVR 220 G e IVR 234 G - alimentazione 230 V ac 50 Hz - tempo manovra 12s/90° tipologia 2-point SPST con Cable  
 Actuator for diverter valves IVR 220 G and IVR 234 G - power supply 230 V ac 50 Hz - manoeuvre time 12s/90° type 2-point SPST with Cable  
 Stellantrieb für IVR 220 G- und IVR 234 G-Umschaltventile - Stromversorgung 230 V ac 50 Hz - Manöverzeit 12s/90° Typ 2-Punkt-SPST mit Kabel  
 Servocommande pour vannes de dérivation IVR 220 G et IVR 234 G - alimentation 230 V ac 50 Hz - temps de manoeuvre 12s/90° type 2-point SPST avec câble  
 Сервопривод для отводных клапанов IVR 220 G и IVR 234 G - питание 230 В пер.т. 50 Hz - время хода 12с/90° тип 2-точечное SPST с кабелем

Cod./Code	□/田	€
121503012	1/15	138,04

## FLANGIA ISO

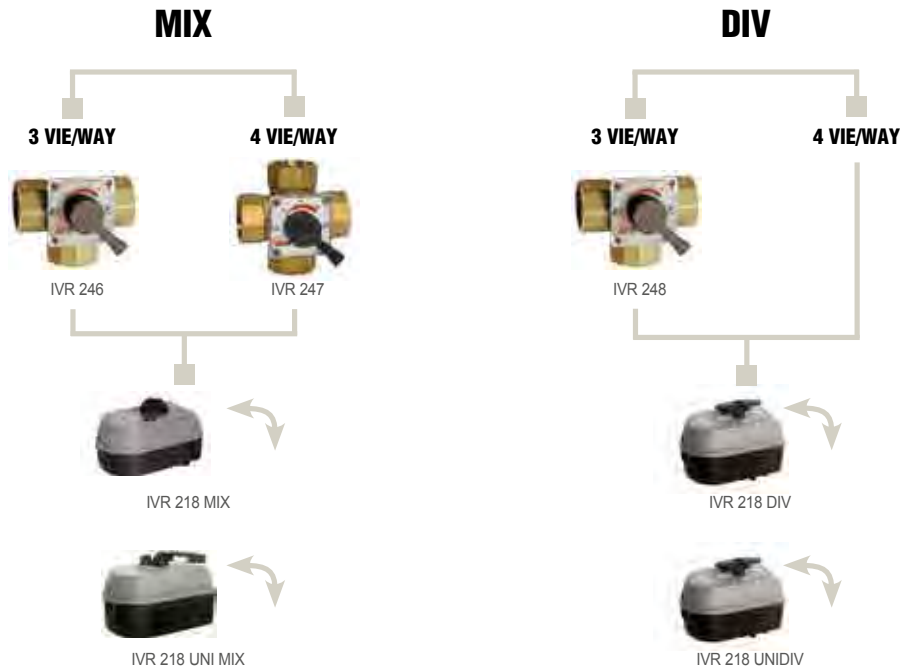

## ATTACCO RAPIDO (EASY)





## AUTOMAT MIX + MOTORHEAD MIX

### IVR 246 + IVR 218 MIX



**ERC**

IVR 246 - Valvola miscelatrice rotante a tre vie in ottone - attacchi F/F/F + MOTORHEAD 218 MIX - Servocomando bidirezionale per valvole miscelatrici rotanti- 230 V - 3 punti

IVR 246 - 3-way rotary mixing valve in brass - F/F/F + MOTORHEAD IVR 218 MIX - Electrical actuators bidirectional for rotary mixing valves - 230 V - 3 point control

IVR 246 - drehbares 3-Wege-Mischventil aus Messing - IG/IG/IG + Motorhead 218 MIX - bidirektionale Servosteuerung für drehbare Mischventile - 230V - 3 Punkt-Steuerung

IVR 246 - vanne trois voies mélangeuse tournante - F/F/F + Motorhead 218 MIX - actionneur électrique bidirectionnel pour vannes mélangeuses tournantes - 230 V - contrôle de 3 points

IVR 246 - трехходовой поворотный смесительный клапан из латуни. Соединение: резьба В/В/В + MOTORHEAD 218 MIX - двунаправленный сервопривод для смесительных поворотных шаровых кранов - 230 V -3 контакт

Cod./Code	Mod./Model	Mis./Size	□/田	€
424605005	105 sec.	1/2"	1/9	164,86
424605010	210 sec.	1/2"	1/9	164,86
424607005	105 sec.	3/4"	1/9	169,79
424607010	210 sec.	3/4"	1/9	169,79
424610005	105 sec.	1"	1/9	173,22
424610010	210 sec.	1"	1/9	173,22
424612005	105 sec.	1"1/4	1/9	181,59
424612010	210 sec.	1"1/4	1/9	181,59



### IVR 247 + IVR 218 MIX



**ERC**

IVR 247 - Valvola miscelatrice rotante a quattro vie in ottone - attacchi F/F/F/F + MOTORHEAD IVR 218 MIX - Servocomando bidirezionale per valvole miscelatrici rotanti- 230 V - 3 punti

IVR 247 - 4-way rotary mixing valve - F/F/F/F + MOTORHEAD IVR 218 MIX - Electrical actuators bidirectional for rotary mixing valves - 230 V - 3 point control

IVR 247 drehbares 4-Wege-Mischventil - aus Messing - IG/IG/IG/IG + Motorhead IVR 218 MIX - bidirektionale Servosteuerung für drehbares Mischventile - 230 V - 3 Punkt-Steuerung

IVR 247 - vanne quatre voies mélangeuse tournante - F/F/F/F + Motorhead IVR 218 MIX - actionneur électrique bidirectionnel pour vannes mélangeuses tournantes- 230 V - contrôle de 3 points

IVR 247 - четырехходовой поворотный смесительный клапан из латуни. Соединение: резьба В/В/В/В + MOTORHEAD 218 MIX - двунаправленный сервопривод для смесительных поворотных шаровых кранов - 230 V - 3 контакт

Cod./Code	Mod./Model	Mis./Size	□/田	€
424705005	105 sec.	1/2"	1/9	164,86
424705010	210 sec.	1/2"	1/9	164,86
424707005	105 sec.	3/4"	1/9	169,79
424707010	210 sec.	3/4"	1/9	169,79
424710005	105 sec.	1"	1/9	173,22
424710010	210 sec.	1"	1/9	173,22
424712005	105 sec.	1"1/4	1/9	176,67
424712010	210 sec.	1"1/4	1/9	176,67



## AUTOMAT MIX

### IVR 246



Valvola miscelatrice rotante a tre vie in ottone - attacchi F/F/F  
3-way brass rotary mixing valve - F/F/F  
Drehbares 3-Wege-Mischventil - aus Messing - IG/IG/IG  
Vanne trois voies mélangeuse tournante en laiton - F/F/F  
Трехходовой латунный поворотный смесительный клапан. Соединение: резьба В/В/В

Cod./Code	Mis./Size	DN	□/田	€
124605001	1/2"	15	1/28	56,60
124607001	3/4"	20	1/28	68,41
124610001	1"	25	1/20	71,36
124612001	1"1/4	32	1/20	76,29



### IVR 247



Valvola miscelatrice rotante a quattro vie in ottone - attacchi F/F/F/F  
4-way brass rotary mixing valve - F/F/F/F  
Drehbares 4-Wege-Mischventil - aus Messing - IG/IG/IG/IG  
Vanne quatre voies mélangeuse tournante en laiton - F/F/F/F  
Четырехходовой поворотный смесительный клапан из латуни. Соединение: резьба В/В/В/В

Cod./Code	Mis./Size	DN	□/田	€
124705001	1/2"	15	1/28	56,60
124707001	3/4"	20	1/28	68,41
124710001	1"	25	1/20	71,36
124712001	1"1/4	32	1/20	76,29



## MOTORHEAD MIX / UNIMIX

### IVR 218 MIX



IVR 218 MIX MOTORHEAD - Servocomando bidirezionale per valvole miscelatrici rotanti - 230 V - 3 punti  
IVR 218 MIX MOTORHEAD - Electrical actuators bidirectional for mixing rotary valves - 230 V - 3 point control  
IVR 218 MIX MOTORHEAD - bidirektionale Servosteuerung für Dreh-Mischventile - 230 V - 3 Punkt-Steuerung  
IVR 218 MIX MOTORHEAD - actionneur électrique double-directionnel pour vannes mélangeuses à rotor - 230 V - 3 points  
IVR 218 MIX MOTORHEAD - двунаправленный сервопривод для смесительных поворотных клапанов - 230 V - 3 контактных зажима

Cod./Code	Mod./Model	□/田	€
121803005	230V - 8Nm 105 sec.	1/9	115,66
121803010	230V - 8Nm 210 sec.	1/9	115,66



**ERC**

### IVR 218 UNIMIX



IVR 218 MOTORHEAD UNIMIX - Servocomando bidirezionale per valvole miscelatrici rotanti a sfera - 230 V - 3 punti  
IVR 218 MOTORHEAD UNIMIX - Electrical actuators bidirectional for mixing rotary ball valve - 230 V - 3 point control - Universal connections  
IVR 218 MOTORHEAD UNIMIX - bidirektionale Servosteuerung für Dreh-Mischventile - 230 V - 3 Punkt-Steuerung  
IVR 218 MOTORHEAD UNIMIX - actionneur électrique double-directionnel pour vannes mélangeuses à rotor - 230 V - 3 points  
IVR 218 MOTORHEAD UNIMIX - двунаправленный сервопривод для смесительных поворотных клапанов - 230 V - 3 контактных зажима

Cod./Code	Mod./Model	□/田	€
121803320	230V - 8Nm 73 sec.	1/9	120,56
121803330	230V - 8Nm 147 sec.	1/9	122,54



**ERC**

## AUTOMAT DIV + MOTORHEAD DIV

### IVR 248 + IVR 218 DIV



**ERC**

IVR 248 - Valvola deviatrice rotante a 3 vie in ottone - attacchi F/F/F + MOTORHEAD 218 DIV - servocomando bidirezionale rotazione non definita per valvole deviatrici rotanti - 230 V con relé - 2 punti

IVR 248 - 3-way rotary diverter valve in brass - F/F/F + MOTORHEAD 218 DIV - Electrical actuators with undefined rotation bidirectional for diverting rotary valves - 230 V - 2 point control with relay

IVR 248 - drehbares 3 Wege-Ableitventil aus Messing- IG/IG/IG + Motorhead 218 DIV - bidirektionale Servosteuerung - unbestimmte Schwenkung für drehbare Ableitventile - 230V mit Relais - 2 Punkt

IVR 248 - vanne déviatrice trois voies - F/F/F + Motorhead 218 DIV - actionneur électrique avec rotation indéfinie bidirectionnelle pour vannes déviateurs tournantes - 230 V - avec relais - contrôle de 2 points

IVR 248 - трехходовой поворотный распределительный клапан из латуни. Соединение: В/В/В + MOTORHEAD 218 DIV - двунаправленный сервопривод для смесительных поворотных клапанов - 230 V с реле - 2 контактных зажима

Cod./Code	Mod./Model	Mis./Size	□/⊕	€
424805050	18 sec.	1/2"	1/9	140,25
424807050	18 sec.	3/4"	1/9	147,15
424810050	18 sec.	1"	1/9	150,10
424812050	18 sec.	1 1/4"	1/9	156,98



## AUTOMAT DIV

### IVR 248



Valvola deviatrice rotante a tre vie in ottone - attacchi F/F/F

3-way rotary diverter valve in brass - F/F/F

Drehbares 3-Wege-Ableitventil aus Messing - IG/IG/IG

Vanne déviatrice tournante trois voies tournante - F/F/F

Трехходовой распределительный поворотный латунный клапан. Соединение: В/В/В

Cod./Code	Mis./Size	DN	□/⊕	€
124805001	1/2"	15	1/28	56,60
124807001	3/4"	20	1/28	68,41
124810001	1"	25	1/20	71,36
124812001	1 1/4"	32	1/20	77,26



## MOTORHEAD DIV / UNI DIV

### IVR 218 DIV



**ERC**

IVR 218 MOTORHEAD DIV - Servocomando bidirezionale rotazione non definita per valvole deviatrici rotanti - 230 V - con relé - 2 punti

IVR 218 MOTORHEAD DIV - Electrical actuators undefined rotation bidirectional for diverting rotary valve - 230 V - with relay - 2 point control

IVR 218 MOTORHEAD DIV - bidirektionale Servosteuerung - nicht bestimmte Schwenkung für Dreh - Steuerventile - 230 V mit Relais - 2 Punkt-Steuerung

IVR 218 MOTORHEAD DIV - actionneur électrique double-directionnel avec rotation indéfinie pour vannes de répartition à rotor - 230 V - avec relé - 2 points

IVR 218 MOTORHEAD DIV - двунаправленный сервопривод для распределительных поворотных клапанов - 230 V - с реле - 2 контактных зажима

Cod./Code	Mod./Model	□/⊕	€
121803050	230V - 8Nm 18 sec.	1/9	95,97



## IVR 218 UNI DIV



**ERC**

IVR 218 MOTORHEAD UNI DIV - Servocomando bidirezionale per valvole deviatrici rotanti a sfera - 230 V - con relé - 2 punti

IVR 218 MOTORHEAD UNI DIV - Electrical actuators bidirectional for diverting rotary ball valve - 230 V - with relay - 2 point control

IVR 218 MOTORHEAD UNI DIV - bidirektionale Servosteuerung für Dreh - Steuerventile - 230V mit Relais - 2 Punkt-Steuerung

IVR 218 MOTORHEAD UNI DIV - actionneur électrique double-directionnel pour vannes de répartition à rotor - 230 V - avec relé - 2 points

IVR 218 MOTORHEAD UNI DIV - двунаправленный сервопривод для распределительных поворотных клапанов - 230 V - с реле - 2 контактных зажима

Cod./Code	Mod./Model	□/⊕	€
121803205	230V - 10Nm 16 sec.	1/9	107,78



## AUTOMAT MIX EASY + MOTORHEAD MIX EASY

## IVR 245 MIX EASY + IVR 215 MIX EASY



IVR 245 - Valvola miscelatrice rotante a tre vie in ottone - attacchi F/F/F + MOTORHEAD 215 MIX EASY - Servocomando bidirezionale rotazione non definita per valvole miscelatrici rotanti - 230 V - 3 punti

IVR 245 - 3-way rotary mixing valve in brass - F/F/F + MOTORHEAD 215 MIX EASY - bidirectional electrical actuator with undefined rotation for mixing rotary valves - 230 V - 3 point control

IVR 245 - drehbares 3-Wege-Mischventil - aus Messing - IG/IG/IG + MOTORHEAD 215 MIX EASY - bidirektionale Servosteuerung - unbestimmte Schwenkung für drehbares Mischventile - 230 V - 3 Punkt

IVR 245 - vanne mélangeuse trois voies tournante - F/F/F + MOTORHEAD 215 MIX EASY - actionneur électrique bidirectionnel avec rotation indéfinie pour vannes mélangeuses tournantes - 230 V - 3 contrôle du point

IVR 245 - трехходовой поворотный смесительный клапан из латуни. Соединение: резьба В/В/В + MOTORHEAD 215 MIX EASY - Двунаправленный сервопривод для смесительных поворотных клапанов - 230 V - 3 контактных зажима

Cod./Code	Mod./Model	Mis./Size	□/⊕	€
424507110	110 sec.	3/4"	1/9	142,71
424510110	110 sec.	1"	1/9	147,64



## AUTOMAT MIX EASY

## IVR 245 MIX EASY



Valvola miscelatrice rotante a tre vie in ottone - attacchi F/F/F

3-way rotary mixing valve in brass - F/F/F

Drehbares 3-Wege-Ableitventil aus Messing - IG/IG/IG

Vanne mélangeuse trois voies tournante - F/F/F

Трехходовой поворотный распределительный клапан из латуни. Соединение: резьба В/В/В

Cod./Code	Mis./Size	□/⊕	€
124507001	3/4"	1/28	53,64
124510001	1"	1/20	71,36



## MOTORHEAD MIX EASY

### IVR 215 MIX EASY



Servocomando bidirezionale rotazione non definita per valvole miscelatrici rotanti - 230 V - 3 punti  
 Bidirectional electrical actuator with undefined rotation for mixing rotary valve - 230 V - 3 point control  
 Bidirektionale Servosteuerung - nicht bestimmte Schwenkung für Dreh-Mischventile - 230V - 3 Punkt-Steuerung  
 Actionneur électrique double-directionnel avec rotation indéfinie pour vannes mélangeuses à rotor - 230 V - 3 contrôle du point  
 Двухнаправленный сервопривод для смешительных поворотных клапанов - 230 V - с реле - 3 контактных зажима

Cod./Code	Mod./Model	□/田	€
121503110	230V - 110 sec.	1/9	78,74



**ERC**

## AUTOMAT DIV EASY + MOTORHEAD DIV EASY

### IVR 249 DIV EASY + IVR 215 DIV EASY



IVR 249 - Valvola deviatrice rotante a tre vie in ottone - attacchi F/F/F + MOTORHEAD 215 DIV EASY  
 Servocomando bidirezionale rotazione non definita per valvole deviatrici rotanti - 230 V - con relé - 2 punti  
 IVR 249 - 3-way rotary diverter valve in brass - F/F/F + MOTORHEAD 215 DIV EASY Electrical actuators with undefined rotation bidirectional for rotary diverter valves - 230 V - with relay - 2 point control  
 IVR 249 - drehbares 3 Wege-Ableitventil aus Messing - IG/IG/IG + MOTORHEAD 215 DIV EASY bidirektionale Servosteuerung - unbestimmte Schwenkung für Ableitventile - 230V mit Relais - 2 Punkt  
 IVR 249 - vanne déviatrice trois voies tournante - F/F/F + MOTORHEAD 215 DIV EASY - actionneur électrique bidirectionnel avec rotation indéfinie pour vannes déviateurs tournantes- 230 V - 2 contrôle du point  
 IVR 249 - трехходовой поворотный распределительный клапан из латуни. Соединение: резьба В/В/В + MOTORHEAD 215 DIV EASY - Двухнаправленный сервопривод для распределительных поворотных клапанов - 230 V - с реле - 2 контактных зажима

Cod./Code	Mod./Model	Mis./Size	□/田	€
424907013	13 sec.	3/4"	1/9	144,26
424910013	13 sec.	1"	1/9	147,64



## AUTOMAT DIV EASY

### IVR 249 DIV EASY



Valvola deviatrice rotante a tre vie in ottone - attacchi F/F/F  
 3-way rotary diverter valve in brass - F/F/F  
 Drehbares 3-Wege-Ableitventil aus Messing - IG/IG/IG  
 Vanne déviatrice trois voies tournante en laiton - F/F/F  
 Трехходовой поворотный распределительный клапан из латуни. Соединение: резьба В/В/В

Cod./Code	Mis./Size	□/田	€
124907001	3/4"	1/28	68,41
124910001	1"	1/20	71,36



## MOTORHEAD DIV EASY

### IVR 215 DIV EASY

SU RICHIESTA  
 ?  
 ON DEMAND



Servocomando bidirezionale rotazione non definita per valvole deviatrici rotanti - 230 V - con relé - 2 punti  
 Electrical actuators with undefined rotation bidirectional for diverter rotary valves - 230 V - with relay - 2 point control  
 Bidirektionale Servosteuerung - unbestimmte Schwenkung für Ableitventile - 230V mit Relais - 2 Punkt  
 Actionneur électrique bidirectionnel avec rotation indéfinie pour vannes déviateurs tournantes- 230 V - 2 contrôle du point  
 Двухнаправленный сервопривод для смесительных поворотных клапанов - 230 V - с реле - 2 контактных зажима

Cod./Code	Mod./Model	□/田	€
121503013	230V - 13 sec.	1/9	78,74



ERC

## ACCESSORI PER LINEA VALVOLE MOTORIZZATE ACCESSORIES FOR MOTORIZED VALVES LINE

### IVR 215 D



Distanziale per isolamento termico per IVR 215  
 Thermal insulation box for IVR215  
 Thermische Isolierbox für IVR 215  
 Coque d'isolation thermique IVR 215  
 Теплоизоляционная коробка для IVR 215

Cod./Code	□/田	€
121501001	10/180	32,48

ERC

**Applicazioni es./Applications ex.:**

Sistema ACS con impianto solare  
 Domestic hot waters system with solar collector

Riscaldamento con caldaia e radiatori Radiator heating with gas boiler

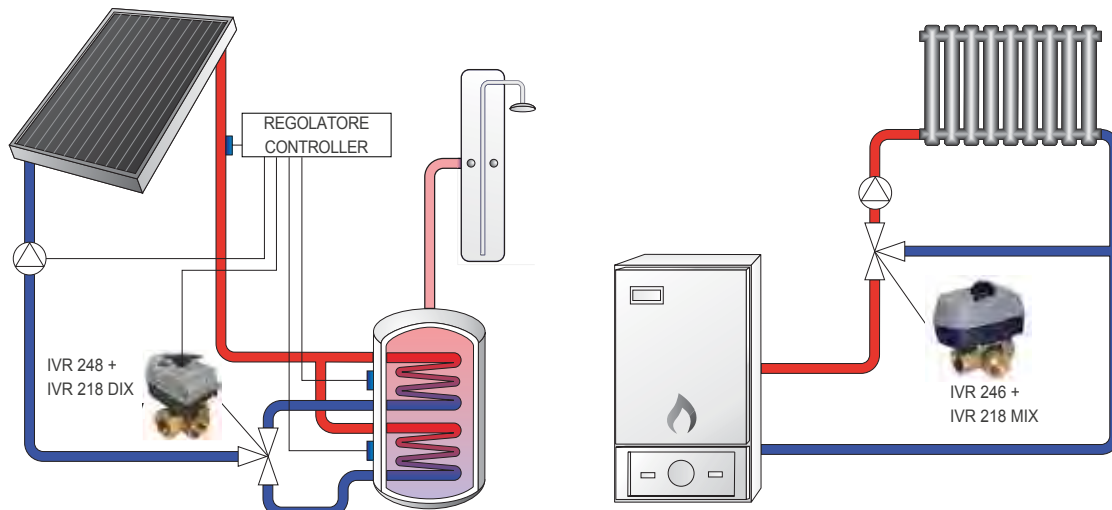





**VALVOLE ACQUA**  
WATER VALVES  
KUGELHÄHNE FÜR WASSER  
VANNES EAU  
ЗАПОРНАЯ АРМАТУРА ДЛЯ ВОДЫ



<b>IVR TOP</b>	p. 111	<b>IVR IDRETTO</b>	p. 154
<b>IVR EXPORT</b>	p. 112	<b>IVR MIGNON</b>	p. 155
<b>IVR EVERLAST</b>	p. 119	<b>IVR RUBINETTI</b>	
<b>IVR EVERMID</b>	p. 129	<i>IVR SANITARY TAPS</i>	p. 156
<b>VALVOLE BOCCHETTONE GLOBO</b>		<b>IVR INCASSO</b>	
<i>VALVES GLOBO WITH TAIL PIECE</i>	p. 135	<i>IVR BUILT-IN VALVES</i>	p. 157
<b>IVR ELITE GREEN WATER 4MS</b>	p. 137	<b>IVR RITEGNO E FILTRI</b>	
<b>IVR QUADRO</b>	p. 142	<i>IVR CHECK VALVES AND Y STRAINER</i>	p. 158
<b>IVR SOLAR LINE</b>	p. 143	<b>IVR SARACINESCHE</b>	
<b>IVR NPT</b>	p. 146	<i>IVR GATE VALVES</i>	p. 162
<b>IVR DZR</b>	p. 147	<b>IVR RIDUTTORE DI PRESSIONE</b>	
<b>IVR NORDIKA</b>	p. 149	<i>IVR PRESSURE REDUCING</i>	p. 164
<b>IVR DRAIN</b>	p. 150	<b>FILTRO AUTOPULENTE</b>	
<b>IVR VALVOLA CON FILTRO</b>		<i>SELF-CLEANING FILTER</i>	p. 166
<i>IVR VALVE WITH STRAINER</i>	p. 151	<b>RACCORDI A PRESSARE EVERFIT</b>	
<b>IVR RIDUTTORE DI MANOVRA</b>		<i>PRESS FITTINGS EVERFIT</i>	p. 167
<i>IVR VALVE WITH GEAR HANDLE</i>	p. 151	<b>IVR RACCORDERIA</b>	
<b>IVR TRE VIE</b>		<i>IVR FITTINGS</i>	p. 171
<i>IVR 3 WAYS</i>	p. 152	<b>ACCESSORI LINEA ACQUA</b>	
		<i>ACCESSORIES FOR WATER LINE</i>	p. 176
		<b>RICAMBI LINEA ACQUA</b>	
		<i>SPARE PARTS FOR WATER LINE</i>	p. 177

## IVR TOP

50 bar

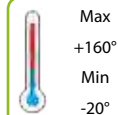

Max  
+160°  
Min  
-20°



UNI EN 10226-1  
(ISO 7-1 Rp)

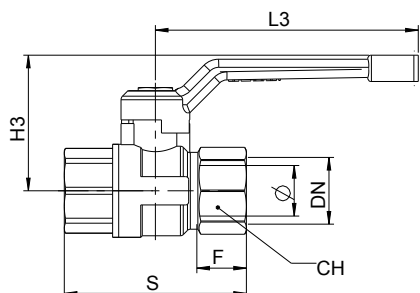

**IVR 48**

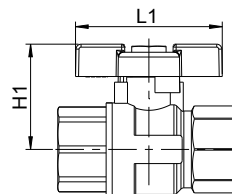

**IVR 48/A**

### DIMENSIONI / DIMENSIONS

DN	Ø	S	L1	L3	H1	H3	F	CH
3/8"	10	60	50	85	33	44	19	22
1/2"	15	75	61	110	39	52	23	26
3/4"	20	80	61	110	43	55	23,5	31
1"	25	90	72	130	52	67	24,5	40
1"1/4	32	110		130		72	31	49
1"1/2	40	120		160		90	32	55
2"	50	141		160		95	36	68

## IVR 48 TOP



Valvola a sfera a passaggio totale - attacchi F/F  
Full bore ball valve - threaded ends F/F - 7 Threads  
Kugelhahn mit vollem Durchgang - IG/IG  
Vanne à boisseau sphérique à passage intégral - Fixations F/F  
Полнопроходной шаровой кран - Соединения В/В

Cod./Code	Mis./Size	Ø	□/田	€
104803024	3/8"	10	10/120	7,39
104805024	1/2"	15	5/60	11,09
104807024	3/4"	20	15/60	14,46
104810024	1"	25	10/40	25,16
104812024	1"1/4	32	4/16	36,92
104815024	1"1/2	40	4/16	52,93
104820024	2"	50	2/8	83,57



## IVR 48/A TOP



Valvola a sfera a passaggio totale - attacchi F/F  
Full bore ball valve - threaded ends F/F - 7 Threads  
Kugelhahn mit vollem Durchgang - IG/IG  
Vanne à boisseau sphérique à passage intégral - fixations F/F  
Полнопроходной шаровой кран - Соединения В/В

Cod./Code	Mis./Size	Ø	□/田	€
104803021	3/8"	10	10/120	7,39
104805021	1/2"	15	5/60	11,09
104807021	3/4"	20	15/60	14,46
104810021	1"	25	10/40	25,16



### ACCESSORI / RICAMBI - ACCESSORIES / SPARE PARTS

3/8"	700702001	703002001	750106001	125603440	125603600	109702030
1/2"	700712001	703012001	750108001	125605440	125605600	109705030
3/4"	700712001	703012001	750108001	125605440	125605600	109705030
1"	700722001	703022001	750110001	125610440	125610600	109710030
1"1/4	700722001		750110001	125610440	125610600	109710030
1"1/2	700732001		750114001	125615440	125615600	109715030
2"	700732001		750114001	125615440	125615600	109715030

Prezzi indicati nella sezione Accessori/Ricambi a fine capitolo / Prices in section Accessories/Spare Parts at the end of this chapter

## IVR EXPORT

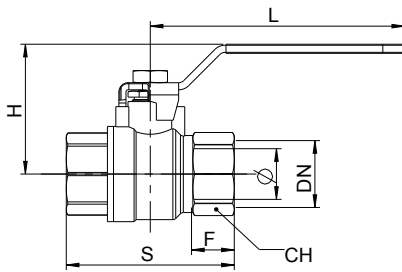
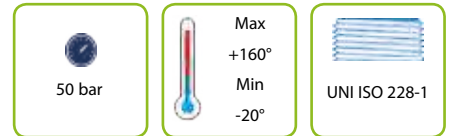

**IVR 45**

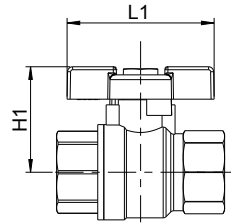

**IVR 45/A**

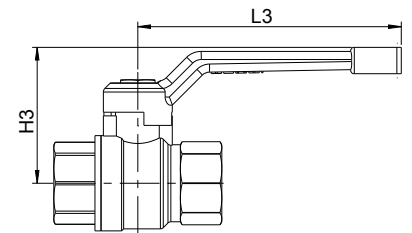

**IVR 45 PLUS**

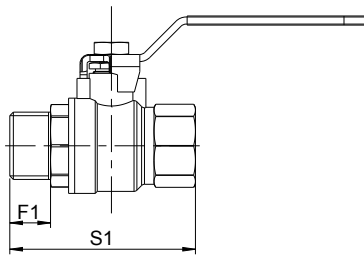

**IVR 46**

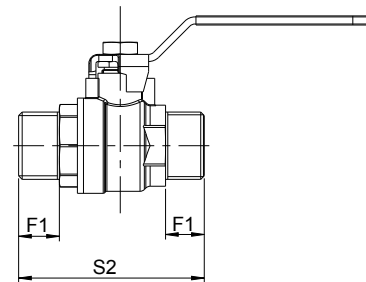

**IVR 47**

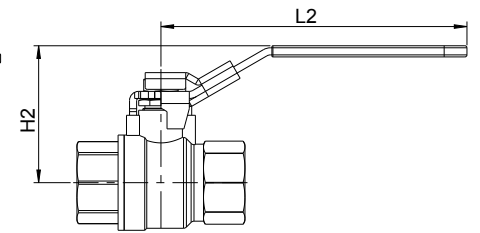

**IVR 45 LD**

### DIMENSIONI / DIMENSIONS

DN	Ø	S	S1	S2	L	L1	L2	L3	H	H1	H2	H3	F	F1	CH
1/4"	10	45	42	52	80	50	95	85	40	33	43	44	12	10	21
3/8"	10	45	54	54	80	50	95	85	40	33	44	44	12	12	21
1/2"	15	63	70	68	90	61	120	110	52	39	56	52	17	15	26
3/4"	20	71	80	77	90	61	120	110	55	43	60	55	19,5	16	31
1"	25	83	92	92	125	72	150	130	64	52	68	67	21	19	38
1 1/4"	32	92	102		125		150	130	69	57	73	72	22	20,5	48
1 1/2"	40	104	117		140		160	160	78		87	88	23,5	21,5	55
2"	50	124	137		140		160	160	85		94	95	28	24,5	68
2 1/2"	60	140			250				131				28		85
3"	74	159			250				140				30,5		99
4"	94	196			250				154				38		125

## IVR 45 PLUS



Valvola a sfera a passaggio totale - attacchi F/F  
Full bore ball valve - threaded ends F/F - 7 Threads  
Kugelhahn mit vollem Durchgang - IG/IG  
Vanne à boisseau sphérique à passage intégral - fixations F/F  
Полнопроходной шаровой кран - Соединения В/В

Cod./Code	Mis./Size	Ø	□/▣	€
104502851	1/4"	10	10/120	6,51
104503851	3/8"	10	10/120	5,85
104505851	1/2"	15	12/72	9,86
104507851	3/4"	20	15/60	13,32
104510851	1"	25	10/40	22,53
104512851	1 1/4"	32	6/24	32,42
104515851	1 1/2"	40	4/16	49,00
104520851	2"	50	2/8	74,73



## IVR 46 PLUS



Valvola a sfera a passaggio totale - attacchi M/F

Full bore ball valve - threaded ends M/F - 7 Threads

Kugelhahn mit vollem Durchgang - AG/IG

Vanne à boisseau sphérique à passage intégral - fixations M/F

Полнопроходной шаровой кран - Соединения Н/В

Cod./Code	Mis./Size	Ø	□/田	€
104602851	1/4"	10	10/120	5,98
104603851	3/8"	10	10/120	6,28
104605851	1/2"	15	12/72	10,26
104607851	3/4"	20	15/60	13,92
104610851	1"	25	10/40	23,57
104612851	1"1/4	32	6/24	35,64
104615851	1"1/2	40	4/16	53,19
104620851	2"	50	2/8	78,83



## IVR 45



Valvola a sfera a passaggio totale - attacchi F/F, con maniglia rossa

Full bore ball valve - threaded ends F/F, with red handle - 7 Threads

Kugelhahn mit vollem Durchgang - IG/IG, mit rotem Hebelgriff

Vanne à boisseau sphérique à passage intégral - fixations F/F, avec poignée rouge

Полнопроходной шаровой кран - Соединения В/В, с красной ручкой

Cod./Code	Mis./Size	Ø	□/田	€
104502107	1/4"	10	10/120	6,05
104503107	3/8"	10	10/120	5,43
104505107	1/2"	15	12/72	9,30
104507107	3/4"	20	15/60	12,87
104510107	1"	25	10/40	20,90
104512107	1"1/4	32	6/24	30,78
104515107	1"1/2	40	4/16	46,89
104520107	2"	50	2/8	72,64
104525107	2"1/2	61	1/6	157,80
104530107	3"	74	1/4	221,75
104540107	4"	95	1/2	365,75



## IVR 45 LB



Valvola a sfera a passaggio totale - attacchi F/F, con maniglia blu

Full bore ball valve - threaded ends F/F, with blue handle - 7 Threads

Kugelhahn mit vollem Durchgang - IG/IG, mit blauem Hebelgriff

Vanne à boisseau sphérique à passage intégral - fixations F/F, avec poignée bleu

Полнопроходной шаровой кран - Соединения В/В, с голубой ручкой

Cod./Code	Mis./Size	Ø	□/田	€
104502209	1/4"	10	10/120	6,05
104503209	3/8"	10	10/120	5,43
104505209	1/2"	15	12/72	9,30
104507209	3/4"	20	15/60	12,87
104510209	1"	25	10/40	20,90
104512209	1"1/4	32	6/24	30,78
104515209	1"1/2	40	4/16	46,89
104520209	2"	50	2/8	72,64
104525209	2"1/2	61	1/6	157,80
104530209	3"	74	1/4	221,75
104540209	4"	95	1/2	365,75



## IVR 45 LN



Valvola a sfera a passaggio totale - attacchi F/F, con maniglia nera  
Full bore ball valve - threaded ends F/F, with black handle - 7 Threads  
Kugelhahn mit vollem Durchgang - IG/IG, mit schwarzem Hebelgriff  
Vanne à boisseau sphérique à passage intégral - fixations F/F, avec poignée noire  
Полнопроходной шаровой кран - Соединения В/В, с чёрной ручкой

Cod./Code	Mis./Size	Ø	□/⊕	€
104502220	1/4"	10	10/120	6,05
104503220	3/8"	10	10/120	5,43
104505220	1/2"	15	12/72	9,30
104507220	3/4"	20	15/60	12,87
104510220	1"	25	10/40	20,90
104512220	1 1/4"	32	6/24	30,78
104515220	1 1/2"	40	4/16	46,89
104520220	2"	50	2/8	72,64
104525220	2 1/2"	61	1/6	157,80
104530220	3"	74	1/4	221,75
104540220	4"	95	1/2	365,75



## IVR 45/A



Valvola a sfera a passaggio totale - attacchi F/F, con farfalla rossa  
Full bore ball valve - threaded ends F/F, with red butterfly handle - 7 Threads  
Kugelhahn mit vollem Durchgang - IG/IG, mit rotem Flügelgriff  
Vanne à boisseau sphérique à passage intégral - fixations F/F, avec papillon rouge  
Полнопроходной шаровой кран - Соединения В/В, с красной ручкой "бабочка"

Cod./Code	Mis./Size	Ø	□/⊕	€
104502004	1/4"	10	10/120	6,05
104503004	3/8"	10	10/120	5,43
104505004	1/2"	15	12/72	9,30
104507004	3/4"	20	15/60	12,87
104510004	1"	25	10/40	20,90



## IVR 45/A FB



Valvola a sfera a passaggio totale - attacchi F/F, con farfalla blu  
Full bore ball valve - threaded ends F/F, with blue butterfly handle - 7 Threads  
Kugelhahn mit vollem Durchgang - IG/IG, mit blauem Flügelgriff  
Vanne à boisseau sphérique à passage intégral - fixations F/F, avec papillon bleu  
Полнопроходной шаровой кран - Соединения В/В, с голубой ручкой "бабочка"

Cod./Code	Mis./Size	Ø	□/⊕	€
104502211	1/4"	10	10/120	6,05
104503211	3/8"	10	10/120	5,43
104505211	1/2"	15	12/72	9,30
104507211	3/4"	20	15/60	12,87
104510211	1"	25	10/40	20,90





## IVR 45/A FN



Valvola a sfera a passaggio totale - attacchi F/F, con farfalla nera  
Full bore ball valve - threaded ends F/F, with black butterfly handle - 7 Threads  
Kugelhahn mit vollem Durchgang - IG/IG, mit schwarzem Flügelgriff  
Vanne à boisseau sphérique à passage intégral - fixations F/F, avec papillon noire  
Полнопроходной шаровой кран - Соединения В/В, с чёрной ручкой "бабочка"

Cod./Code	Mis./Size	Ø	□/田	€
104502221	1/4"	10	10/120	6,05
104503221	3/8"	10	10/120	5,43
104505221	1/2"	15	12/72	9,30
104507221	3/4"	20	15/60	12,87
104510221	1"	25	10/40	20,90



## IVR 46



Valvola a sfera a passaggio totale - attacchi M/F, con maniglia rossa  
Full bore ball valve - threaded ends M/F, with red handle - 7 Threads  
Kugelhahn mit vollem Durchgang - AG/IG, mit rotem Hebelgriff  
Vanne à boisseau sphérique à passage intégral - fixations M/F, avec poignée rouge  
Полнопроходной шаровой кран - Соединения Н/В, с красной ручкой

Cod./Code	Mis./Size	Ø	□/田	€
104602006	1/4"	10	10/120	5,56
104603006	3/8"	10	10/120	5,83
104605006	1/2"	15	12/72	9,73
104607006	3/4"	20	15/60	13,35
104610006	1"	25	10/40	21,99
104612006	1"1/4	32	6/24	33,96
104615006	1"1/2	40	4/16	51,09
104620006	2"	50	2/8	76,74



## IVR 46 LB



Valvola a sfera a passaggio totale - attacchi M/F, con maniglia blu  
Full bore ball valve - threaded ends M/F, with blue handle - 7 Threads  
Kugelhahn mit vollem Durchgang - AG/IG, mit blauem Hebelgriff  
Vanne à boisseau sphérique à passage intégral - fixations M/F, avec poignée bleu  
Полнопроходной шаровой кран - Соединения Н/В, с голубой ручкой

Cod./Code	Mis./Size	Ø	□/田	€
104602209	1/4"	10	10/120	5,56
104603209	3/8"	10	10/120	5,83
104605209	1/2"	15	12/72	9,73
104607209	3/4"	20	15/60	13,35
104610209	1"	25	10/40	21,99
104612209	1"1/4	32	6/24	33,96
104615209	1"1/2	40	4/16	51,09
104620209	2"	50	2/8	76,74



## IVR 46 LN



Valvola a sfera a passaggio totale - attacchi M/F, con maniglia nera  
Full bore ball valve - threaded ends M/F, with black handle- 7 Threads  
Kugelhahn mit vollem Durchgang - AG/IG, mit schwarzem Hebelgriff  
Vanne à boisseau sphérique à passage intégral - fixations M/F, avec poignée noire  
Полнопроходной шаровой кран - Соединения Н/В, с чёрной ручкой

Cod./Code	Mis./Size	Ø	□/⊕	€
104602220	1/4"	10	10/120	5,56
104603220	3/8"	10	10/120	5,83
104605220	1/2"	15	12/72	9,73
104607220	3/4"	20	15/60	13,35
104610220	1"	25	10/40	21,99
104612220	1"1/4	32	6/24	33,96
104615220	1"1/2	40	4/16	51,09
104620220	2"	50	2/8	76,74



## IVR 46/A



Valvola a sfera a passaggio totale - attacchi M/F, con farfalla rossa  
Full bore ball valve - threaded ends M/F, with red butterfly handle- 7 Threads  
Kugelhahn mit vollem Durchgang - AG/IG, mit rotem Flügelgriff  
Vanne à boisseau sphérique à passage intégral - fixations M/F, avec papillon rouge  
Полнопроходной шаровой кран - Соединения Н/В, с красной ручкой "бабочка"

Cod./Code	Mis./Size	Ø	□/⊕	€
104602002	1/4"	10	10/120	5,56
104603002	3/8"	10	10/120	5,83
104605002	1/2"	15	12/72	9,73
104607002	3/4"	20	15/60	13,35
104610002	1"	25	10/40	21,99



## IVR 46/A FB



Valvola a sfera a passaggio totale - attacchi M/F, con farfalla blu  
Full bore ball valve - threaded ends M/F, with blue butterfly handle- 7 Threads  
Kugelhahn mit vollem Durchgang - AG/IG, mit blauem Flügelgriff  
Vanne à boisseau sphérique à passage intégral - fixations M/F, avec papillon bleu  
Полнопроходной шаровой кран - Соединения Н/В, с голубой ручкой "бабочка"

Cod./Code	Mis./Size	Ø	□/⊕	€
104602211	1/4"	10	10/120	5,56
104603211	3/8"	10	10/120	5,83
104605211	1/2"	15	12/72	9,73
104607211	3/4"	20	15/60	13,35
104610211	1"	25	10/40	21,99



## IVR 46/A FN



Valvola a sfera a passaggio totale - attacchi M/F, con farfalla nera  
Full bore ball valve - threaded ends M/F, with black butterfly handle- 7 Threads  
Kugelhahn mit vollem Durchgang - AG/IG, mit schwarzem Flügelgriff  
Vanne à boisseau sphérique à passage intégral - fixations M/F, avec papillon noire  
Полнопроходной шаровой кран - Соединения Н/В, с чёрной ручкой "бабочка"

Cod./Code	Mis./Size	Ø	□/田	€
104602221	1/4"	10	10/120	5,56
104603221	3/8"	10	10/120	5,83
104605221	1/2"	15	12/72	9,73
104607221	3/4"	20	15/60	13,35
104610221	1"	25	10/40	21,99



## IVR 47



Valvola a sfera a passaggio totale - attacchi M/M, con maniglia rossa  
Full bore ball valve - threaded ends M/M, with red handle- 7 Threads  
Kugelhahn mit vollem Durchgang - AG/AG, mit rotem Hebelgriff  
Vanne à boisseau sphérique à passage intégral - fixations M/M, avec poignée rouge  
Полнопроходной шаровой кран - Соединения Н/Н, с красной ручкой

Cod./Code	Mis./Size	Ø	□/田	€
104705006	1/2"	15	12/72	10,51
104707006	3/4"	20	10/40	13,96
104710006	1"	25	10/40	23,71



## IVR 47/A



Valvola a sfera a passaggio totale - attacchi M/M, con farfalla rossa  
Full bore ball valve - threaded ends M/M, with red butterfly handle- 7 Threads  
Kugelhahn mit vollem Durchgang - AG/AG, mit rotem Flügelgriff  
Vanne à boisseau sphérique à passage intégral - fixations M/M, avec papillon rouge  
Полнопроходной шаровой кран - Соединения Н/Н, с красной ручкой "бабочка"

Cod./Code	Mis./Size	Ø	□/田	€
104705002	1/2"	15	12/72	10,51
104707002	3/4"	20	10/60	13,96
104710002	1"	25	10/40	23,71



## IVR 45 LD



Valvola a sfera a passaggio totale - attacchi F/F - con maniglia lucchettabile - Disponibile anche con maniglia blu  
Full bore ball valve - threaded ends F/F - with lockable handle - Available with blue handle- 7 Threads  
Kugelhahn mit vollem Durchgang - IG/IG- mit verriegelbarem Hebel - Erhältlich auch mit blauem Griff  
Vanne à boisseau sphérique à passage intégral - fixations F/F - avec poignée cadenassable - Disponible avec poignée bleu

Полнопроходной шаровой кран - Соединения В/В - с запираемой ручкой - доступен также с голубой ручкой

Cod./Code	Mis./Size	Ø	□/田	€
104502750	1/4"	10	10/120	8,12
104503750	3/8"	10	10/120	7,47
104505750	1/2"	15	12/72	11,60
104507750	3/4"	20	15/60	15,06
104510750	1"	25	10/40	23,55
104512750	1"1/4	32	6/24	33,44
104515750	1"1/2	40	4/16	51,56
104520750	2"	50	2/8	77,30



## IVR 46 LD



Valvola a sfera a passaggio totale - attacchi M/F - con maniglia lucchettabile - Disponibile anche con maniglia blu  
Full bore ball valve - threaded ends M/F - with lockable handle - Available, with blue handle- 7 Threads  
Kugelhahn mit vollem Durchgang - AG/IG - mit verriegelbarem Hebel - Erhältlich auch mit blauem Griff  
Vanne à boisseau sphérique à passage intégral - fixations M/F - avec poignée cadenassable - Disponible avec poignée bleu

Полнопроходной шаровой кран - Соединения Н/В - с запираемой ручкой - Доступен также с голубой ручкой

Cod./Code	Mis./Size	Ø	□/田	€
104602750	1/4"	10	10/120	8,26
104603750	3/8"	10	10/120	7,90
104605750	1/2"	15	10/60	12,01
104607750	3/4"	20	15/60	15,67
104610750	1"	25	8/32	24,61
104612750	1"1/4	32	6/24	36,73
104615750	1"1/2	40	4/16	55,74
104620750	2"	50	2/8	81,15



### ACCESSORI / RICAMBI - ACCESSORIES / SPARE PARTS

											
1/4"	700702001	700101001	700105001	700102001	703001501	703005001	703002001	750106001	125603440	125603600	109702030
3/8"	700702001	700101001	700105001	700102001	703001501	703005001	703002001	750106001	125603440	125603600	109702030
1/2"	700712001	700111001	700115001	700112001	703011501	703015001	703012001	750108001	125605440	125605600	109705030
3/4"	700712001	700111001	700115001	700112001	703011501	703015001	703012001	750108001	125605440	125605600	109705030
1"	700722001	700121001	700125001	700122001	703021501	703025001	703022001	750110001	125610440	125610600	109710030
1"1/4	700722001	700121001	700125001	700122001				750110001	125610440	125610600	109710030
1"1/2	700732001	700131001	700135001	700132001				750114001	125615440	125615600	109715030
2"	700732001	700131001	700135001	700132001				750114001	125615440	125615600	109715030
2"1/2		700151001	700155001	700152001				750118001			109725010
3"		700151001	700155001	700152001				750118001			109725010
4"		700151001	700155001	700152001				750118001			109725010

Prezzi indicati nella sezione Accessori/Ricambi a fine capitolo / Prices in section Accessories/Spare Parts at the end of this chapter

**IVR EVERLAST**

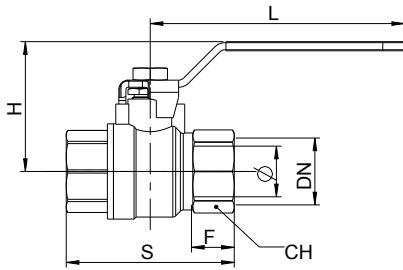
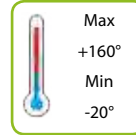
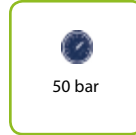

**IVR 954**

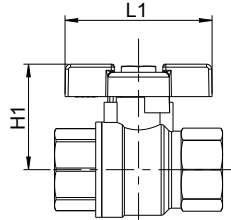

**IVR 954/A**

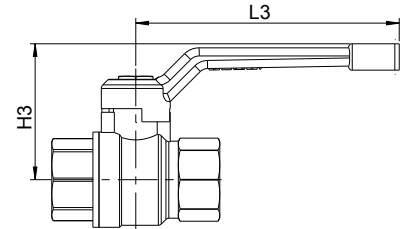

**IVR 954 PLUS**

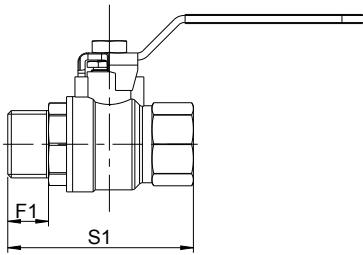

**IVR 956**

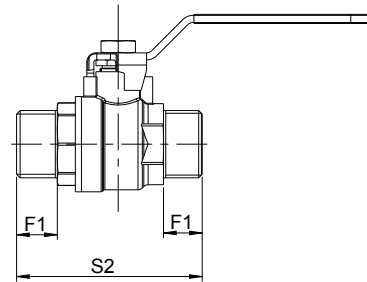

**IVR 957**

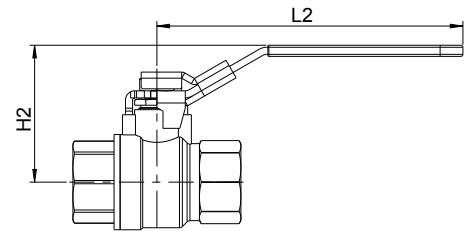

**IVR 954 LD**

DIMENSIONI / DIMENSIONS

DN	Ø	S	S1	S2	L	L1	L2	L3	H	H1	H2	H3	F	F1	CH
1/4"	10	42	43,5	52	80	50	95	85	40	33	43	44	9,5	10	17
3/8"	10	44	45	52	80	50	95	85	40	33	43	44	10,5	10	20
1/2"	15	50	50	58	92	50	95	85	43	37	46	47	11	10,5	25
3/4"	20	57	58	66	92	50	95	85	47	40	46	51	13	13	31
1"	25	70	70	78	115	61	120	110	59	47	64	60	15	15	38
1"1/4	32	80	81	91	115		120	110	64		68	64	17	17	47
1"1/2	40	90	91	102	150		150	130	75		78	78	18	18	54
2"	50	107	107	118	150		150	130	82		86	85	20	20	66
2"1/2	60	132			200				108				22		84
3"	74	151			250				117				26		96
4"	94	179			250				154				30		123



## IVR 954 PLUS



Valvola a sfera a passaggio totale - attacchi F/F  
Full bore ball valve - threaded ends F/F - 5 Threads  
Kugelhahn mit vollem Durchgang - IG/IG  
Vanne à boisseau sphérique à passage intégral - fixations F/F  
Полнопроходной шаровой кран - Соединения В/В

Cod./Code	Mis./Size	Ø	□/⊕	€
195402024	1/4"	10	10/120	6,08
195403024	3/8"	10	10/120	5,88
195405024	1/2"	15	20/120	7,59
195407024	3/4"	20	20/80	10,73
195410024	1"	25	12/48	17,40
195412024	1"1/4	32	8/32	26,68
195415024	1"1/2	40	6/24	40,66
195420024	2"	50	4/16	61,40



## IVR 956 PLUS



Valvola a sfera a passaggio totale - attacchi M/F  
Full bore ball valve - threaded ends M/F - 5 Threads  
Kugelhahn mit vollem Durchgang - AG/IG  
Vanne à boisseau sphérique à passage intégral - fixations M/F  
Полнопроходной шаровой кран - Соединения Н/В

Cod./Code	Mis./Size	Ø	□/⊕	€
195602334	1/4"	10	10/120	5,97
195603334	3/8"	10	10/120	5,65
195605334	1/2"	15	20/120	7,58
195607334	3/4"	20	20/80	10,61
195610334	1"	25	12/48	17,54
195612334	1"1/4	32	8/32	26,60
195615334	1"1/2	40	6/24	39,62
195620334	2"	50	4/16	57,17



## IVR 957 PLUS



Valvola a sfera a passaggio totale - attacchi M/M  
Full bore ball valve - threaded ends M/M - 5 Threads  
Kugelhahn mit vollem Durchgang - AG/AG  
Vanne à boisseau sphérique à passage intégral - fixations M/M  
Полнопроходной шаровой кран - Соединения Н/Н

Cod./Code	Mis./Size	Ø	□/⊕	€
195702334	1/4"	10	10/120	6,29
195703334	3/8"	10	10/120	6,38
195705334	1/2"	15	10/120	8,20
195707334	3/4"	20	20/80	11,07
195710334	1"	25	10/40	18,33
195712334	1"1/4	32	8/32	29,19
195715334	1"1/2	40	6/24	41,87
195720334	2"	50	4/16	59,59





## IVR 954



Valvola a sfera a passaggio totale - attacchi F/F, con maniglia rossa  
Full bore ball valve - threaded ends F/F, with red handle- 5 Threads  
Kugelhahn mit vollem Durchgang - IG/IG, mit rotem Hebelgriff  
Vanne à boisseau sphérique à passage intégral - fixations F/F, avec poignée rouge  
Полнопроходной шаровой кран - Соединения В/В, с красной ручкой

Cod./Code	Mis./Size	Ø	□/田	€
195402007	1/4"	10	10/120	5,32
195403007	3/8"	10	10/120	5,23
195405007	1/2"	15	20/120	6,86
195407007	3/4"	20	20/80	10,01
195410007	1"	25	12/48	16,74
195412007	1"1/4	32	8/32	26,32
195415007	1"1/2	40	6/24	38,23
195420007	2"	50	4/16	58,98
195425007	2"1/2	61	1/8	130,84
195430007	3"	74	1/6	183,19
195440007	4"	95	1/2	293,89



## IVR 954 LB



Valvola a sfera a passaggio totale - attacchi F/F, con maniglia blu  
Full bore ball valve - threaded ends F/F, with blue handle- 5 Threads  
Kugelhahn mit vollem Durchgang - IG/IG, mit blauem Hebelgriff  
Vanne à boisseau sphérique à passage intégral - fixations F/F, avec poignée bleu  
Полнопроходной шаровой кран - Соединения В/В, с голубой ручкой

Cod./Code	Mis./Size	Ø	□/田	€
195402209	1/4"	10	10/120	5,32
195403209	3/8"	10	10/120	5,23
195405209	1/2"	15	20/120	6,86
195407209	3/4"	20	20/80	10,01
195410209	1"	25	12/48	16,74
195412209	1"1/4	32	8/32	26,32
195415209	1"1/2	40	6/24	38,23
195420209	2"	50	4/16	58,98
195425209	2"1/2	61	1/8	130,84
195430209	3"	74	1/6	183,19
195440209	4"	95	1/2	293,89



## IVR 954 LN



Valvola a sfera a passaggio totale - attacchi F/F, con maniglia nera  
Full bore ball valve - threaded ends F/F, with black handle- 5 Threads  
Kugelhahn mit vollem Durchgang - IG/IG, mit schwarzem Hebelgriff  
Vanne à boisseau sphérique à passage intégral - fixations F/F, avec poignée noire  
Полнопроходной шаровой кран - Соединения В/В, с чёрной ручкой

Cod./Code	Mis./Size	Ø	□/田	€
195402219	1/4"	10	10/120	5,32
195403219	3/8"	10	10/120	5,23
195405219	1/2"	15	20/120	6,86
195407219	3/4"	20	20/80	10,01
195410219	1"	25	12/48	16,74
195412219	1"1/4	32	8/32	26,32
195415219	1"1/2	40	6/24	38,23
195420219	2"	50	4/16	58,98
195425219	2"1/2	61	1/8	130,84
195430219	3"	74	1/6	183,19
195440219	4"	95	1/2	293,89



## IVR 954/A



Valvola a sfera a passaggio totale - attacchi F/F, con farfalla rossa  
Full bore ball valve - threaded ends F/F, with red butterfly handle- 5 Threads  
Kugelhahn mit vollem Durchgang - IG/IG, mit rotem Flügelgriff  
Vanne à boisseau sphérique à passage intégral - fixations F/F, avec papillon rouge  
Полнопроходной шаровой кран - Соединения В/В, с красной ручкой "бабочка"

Cod./Code	Mis./Size	Ø	□/⊕	€
195402008	1/4"	10	10/120	5,32
195403008	3/8"	10	10/120	5,23
195405008	1/2"	15	20/120	6,86
195407008	3/4"	20	20/80	10,01
195410008	1"	25	12/48	16,74
195412008	1"1/4	32	8/32	26,32



## IVR 954/A FB



Valvola a sfera a passaggio totale - attacchi F/F, con farfalla blu  
Full bore ball valve - threaded ends F/F, with blue butterfly handle- 5 Threads  
Kugelhahn mit vollem Durchgang - IG/IG, mit blauem Flügelgriff  
Vanne à boisseau sphérique à passage intégral - fixations F/F, avec papillon bleu  
Полнопроходной шаровой кран - Соединения В/В, с голубой ручкой "бабочка"

Cod./Code	Mis./Size	Ø	□/⊕	€
195402211	1/4"	10	10/120	5,32
195403211	3/8"	10	10/120	5,23
195405211	1/2"	15	20/120	6,86
195407211	3/4"	20	20/80	10,01
195410211	1"	25	12/48	16,74
195412211	1"1/4	32	8/32	26,32



## IVR 954/A FN



Valvola a sfera a passaggio totale - attacchi F/F, con farfalla nera  
Full bore ball valve - threaded ends F/F, with black butterfly handle- 5 Threads  
Kugelhahn mit vollem Durchgang - IG/IG, mit schwarzem Flügelgriff  
Vanne à boisseau sphérique à passage intégral - fixations F/F, avec papillon noire  
Полнопроходной шаровой кран - Соединения В/В, с чёрной ручкой "бабочка"

Cod./Code	Mis./Size	Ø	□/⊕	€
195402335	1/4"	10	10/120	5,32
195403335	3/8"	10	10/120	5,23
195405335	1/2"	15	20/120	6,86
195407335	3/4"	20	20/80	10,01
195410335	1"	25	12/48	16,74
195412335	1"1/4	32	8/32	26,32



## IVR 956



Valvola a sfera a passaggio totale - attacchi M/F, con maniglia rossa  
Full bore ball valve - threaded ends M/F, with red handle- 5 Threads  
Kugelhahn mit vollem Durchgang - AG/IG, mit rotem Hebelgriff  
Vanne à boisseau sphérique à passage intégral - fixations M/F, avec poignée rouge  
Полнопроходной шаровой кран - Соединения Н/В, с красной ручкой

Cod./Code	Mis./Size	Ø	□/田	€
195602007	1/4"	10	10/120	5,32
195603007	3/8"	10	10/120	4,98
195605007	1/2"	15	20/120	6,86
195607007	3/4"	20	20/80	9,90
195610007	1"	25	12/48	16,88
195612007	1"1/4	32	8/32	26,26
195615007	1"1/2	40	6/24	37,19
195620007	2"	50	4/16	57,17



## IVR 956 LB



Valvola a sfera a passaggio totale - attacchi M/F, con maniglia blu  
Full bore ball valve - threaded ends M/F, with blue handle- 5 Threads  
Kugelhahn mit vollem Durchgang - AG/IG, mit blauem Hebelgriff  
Vanne à boisseau sphérique à passage intégral - fixations M/F, avec poignée bleu  
Полнопроходной шаровой кран - Соединения Н/В, с голубой ручкой

Cod./Code	Mis./Size	Ø	□/田	€
195602209	1/4"	10	10/120	5,32
195603209	3/8"	10	10/120	4,98
195605209	1/2"	15	20/120	6,86
195607209	3/4"	20	20/80	9,90
195610209	1"	25	12/48	16,88
195612209	1"1/4	32	8/32	26,26
195615209	1"1/2	40	6/24	37,19
195620209	2"	50	4/16	57,17



## IVR 956 LN



Valvola a sfera a passaggio totale - attacchi M/F, con maniglia nera  
Full bore ball valve - threaded ends M/F, with black handle- 5 Threads  
Kugelhahn mit vollem Durchgang - AG/IG, mit schwarzem Hebelgriff  
Vanne à boisseau sphérique à passage intégral - fixations M/F, avec poignée noire  
Полнопроходной шаровой кран - Соединения Н/В, с чёрной ручкой

Cod./Code	Mis./Size	Ø	□/田	€
195602219	1/4"	10	10/120	5,32
195603219	3/8"	10	10/120	4,98
195605219	1/2"	15	20/120	6,86
195607219	3/4"	20	20/80	9,90
195610219	1"	25	12/48	16,88
195612219	1"1/4	32	8/32	26,26
195615219	1"1/2	40	6/24	37,19
195620219	2"	50	4/16	57,17



## IVR 956/A



Valvola a sfera a passaggio totale - attacchi M/F, con farfalla rossa  
Full bore ball valve - threaded ends M/F, with red butterfly handle- 5 Threads  
Kugelhahn mit vollem Durchgang - AG/IG, mit rotem Flügelgriff  
Vanne à boisseau sphérique à passage intégral - fixations M/F, avec papillon rouge  
Полнопроходной шаровой кран - Соединения Н/В, с красной ручкой "бабочка"

Cod./Code	Mis./Size	Ø	□/⊕	€
195602008	1/4"	10	10/120	5,32
195603008	3/8"	10	10/120	4,98
195605008	1/2"	20	20/120	6,86
195607008	3/4"	32	20/80	9,90
195610008	1"	25	12/48	16,88
195612008	1"1/4	32	8/32	26,26



## IVR 956/A FB



Valvola a sfera a passaggio totale - attacchi M/F, con farfalla blu  
Full bore ball valve - threaded ends M/F, with blue butterfly handle- 5 Threads  
Kugelhahn mit vollem Durchgang - AG/IG, mit blauem Flügelgriff  
Vanne à boisseau sphérique à passage intégral - fixations M/F, avec papillon bleu  
Полнопроходной шаровой кран - Соединения Н/В с голубой ручкой "бабочка"

Cod./Code	Mis./Size	Ø	□/⊕	€
195602211	1/4"	10	10/120	5,32
195603211	3/8"	10	10/120	4,98
195605211	1/2"	15	20/120	6,86
195607211	3/4"	20	20/80	9,90
195610211	1"	25	12/48	16,88
195612211	1"1/4	32	8/32	26,26



## IVR 956/A FN



Valvola a sfera a passaggio totale - attacchi M/F, con farfalla nera  
Full bore ball valve - threaded ends M/F, with black butterfly handle- 5 Threads  
Kugelhahn mit vollem Durchgang - AG/IG, mit schwarzem Flügelgriff  
Vanne à boisseau sphérique à passage intégral - fixations M/F, avec papillon noire  
Полнопроходной шаровой кран - Соединения Н/В, с чёрной ручкой "бабочка"

Cod./Code	Mis./Size	Ø	□/⊕	€
195602335	1/4"	10	10/120	5,32
195603335	3/8"	10	10/120	4,98
195605335	1/2"	15	20/120	6,86
195607335	3/4"	20	20/80	9,90
195610335	1"	25	12/48	16,88
195612335	1"1/4	32	8/32	26,26



## IVR 957



Valvola a sfera a passaggio totale - attacchi M/M, con maniglia rossa  
Full bore ball valve - threaded ends M/M, with red handle- 5 Threads  
Kugelhahn mit vollem Durchgang - AG/AG, mit rotem Hebelgriff  
Vanne à boisseau sphérique à passage intégral - fixations M/M, avec poignée rouge  
Полнопроходной шаровой кран - Соединения Н/Н, с красной ручкой

Cod./Code	Mis./Size	Ø	□/田	€
195702007	1/4"	10	10/120	5,50
195703007	3/8"	10	10/120	5,62
195705007	1/2"	15	10/120	7,64
195707007	3/4"	20	20/80	10,50
195710007	1"	25	10/40	17,68
195712007	1"1/4	32	8/32	28,85
195715007	1"1/2	40	6/24	39,44
195720007	2"	50	4/16	61,16



## IVR 957 LB



Valvola a sfera a passaggio totale - attacchi M/M, con maniglia blu  
Full bore ball valve - threaded ends M/M, with blue handle- 5 Threads  
Kugelhahn mit vollem Durchgang - AG/AG, mit blauem Hebelgriff  
Vanne à boisseau sphérique à passage intégral - fixations M/M, avec poignée bleu  
Полнопроходной шаровой кран - Соединения Н/Н, синяя ручка "бабочка"

Cod./Code	Mis./Size	Ø	□/田	€
195702209	1/4"	10	10/120	5,50
195703209	3/8"	10	10/120	5,62
195705209	1/2"	15	10/120	7,64
195707209	3/4"	20	20/80	10,50
195710209	1"	25	10/40	17,68
195712209	1"1/4	32	8/32	28,85
195715209	1"1/2	40	6/24	39,44
195720209	2"	50	4/16	61,16



## IVR 957 LN



Valvola a sfera a passaggio totale - attacchi M/M, con maniglia nera  
Full bore ball valve - threaded ends M/M, with black handle- 5 Threads  
Kugelhahn mit vollem Durchgang - AG/AG, mit schwarzem Hebelgriff  
Vanne à boisseau sphérique à passage intégral - fixations M/M, avec poignée noire  
Полнопроходной шаровой кран - Соединения Н/Н, с чёрной ручкой

Cod./Code	Mis./Size	Ø	□/田	€
195702219	1/4"	10	10/120	5,50
195703219	3/8"	10	10/120	5,62
195705219	1/2"	15	10/120	7,64
195707219	3/4"	20	20/80	10,50
195710219	1"	25	10/40	17,68
195712219	1"1/4	32	8/32	28,85
195715219	1"1/2	40	6/24	39,44
195720219	2"	50	4/16	61,16



## IVR 957/A



Valvola a sfera a passaggio totale - attacchi M/M, con farfalla rossa  
Full bore ball valve - threaded ends M/M, with red butterfly handle- 5 Threads  
Kugelhahn mit vollem Durchgang - AG/AG, mit rotem Flügelgriff  
Vanne à boisseau sphérique à passage intégral - fixations M/M, avec papillon rouge  
Полнопроходной шаровой кран - Соединения Н/Н, с красной ручкой "бабочка"

Cod./Code	Mis./Size	Ø	□/⊕	€
195702008	1/4"	10	10/120	5,50
195703008	3/8"	10	10/120	5,62
195705008	1/2"	15	10/120	7,64
195707008	3/4"	20	20/80	10,50
195710008	1"	25	10/40	17,68



## IVR 957/A FB



Valvola a sfera a passaggio totale - attacchi M/M, con farfalla blu  
Full bore ball valve - threaded ends M/M, with blue butterfly handle - 5 Threads  
Kugelhahn mit vollem Durchgang - AG/AG, mit blauem Flügelgriff  
Vanne à boisseau sphérique à passage intégral - fixations M/M, avec papillon bleu  
Полнопроходной шаровой кран - Соединения Н/Н, синяя ручка "бабочка"

Cod./Code	Mis./Size	Ø	□/⊕	€
195702211	1/4"	10	10/120	5,50
195703211	3/8"	10	10/120	5,62
195705211	1/2"	15	10/120	7,64
195707211	3/4"	20	20/80	10,50
195710211	1"	25	10/40	17,68



## IVR 957/A FN



Valvola a sfera a passaggio totale - attacchi M/M, con farfalla nera  
Full bore ball valve - threaded ends M/M, with black butterfly handle -5 Threads  
Kugelhahn mit vollem Durchgang - AG/AG, mit schwarzem Flügelgriff  
Vanne à boisseau sphérique à passage intégral - fixations M/M, avec papillon noire  
Полнопроходной шаровой кран - Соединения Н/Н, с чёрной ручкой "бабочка"

Cod./Code	Mis./Size	Ø	□/⊕	€
195702335	1/4"	10	10/120	5,50
195703335	3/8"	10	10/120	5,62
195705335	1/2"	15	10/120	7,64
195707335	3/4"	20	20/80	10,50
195710335	1"	25	10/40	17,68





## IVR 954 LD



Valvola a sfera a passaggio totale - attacchi F/F con maniglia lucchettabile - Nota: Disponibile anche con maniglia blu

Full bore ball valve - threaded ends F/F - with lockable handle - Note: Available with blue handle - -5 Threads

Kugelhahn mit vollem Durchgang - IG/IG- mit verriegelbarem Hebel - ANMERKUNG: Erhältlich auch mit blauem Griff

Vanne à boisseau sphérique à passage intégral - fixations F/F - avec poignée cadenassable - Note: Disponible avec poignée bleu

Полнопроходной шаровой кран - Соединения В/В - с запираемой ручкой - Примечание: доступен также с голубой ручкой



Cod./Code	Mis./Size	Ø	□/田	€
195402750	1/4"	10	10/120	7,34
195403750	3/8"	10	10/120	6,93
195405750	1/2"	15	20/80	8,89
195407750	3/4"	20	20/80	12,01
195410750	1"	25	12/48	19,40
195412750	1"1/4	32	6/24	28,58
195415750	1"1/2	40	4/16	40,91
195420750	2"	50	2/8	61,84



## IVR 956 LD



Valvola a sfera a passaggio totale - attacchi F/F con maniglia lucchettabile - Nota: Disponibile anche con maniglia blu

Full bore ball valve - threaded ends F/F - with lockable handle - Note: Available with blue handle - -5 Threads

Kugelhahn mit vollem Durchgang - IG/IG- mit verriegelbarem Hebel - ANMERKUNG: Erhältlich auch mit blauem Griff

Vanne à boisseau sphérique à passage intégral - fixations F/F - avec poignée cadenassable - Note: Disponible avec poignée bleu

Полнопроходной шаровой кран - Соединения В/В - с запираемой ручкой - Примечание: доступен также с голубой ручкой



Cod./Code	Mis./Size	□/田	€
195605750	1/2"	20/120	9,00
195607750	3/4"	20/80	11,75
195610750	1"	12/48	19,10
195612750	1"1/4	6/24	28,63
195615750	1"1/2	4/16	39,24
195620750	2"	4/16	59,79



## IVR 954/P



Valvola a sfera a passaggio totale - attacchi F/F, con maniglia rossa e prolunga per coibentazione

Full bore ball valve - threaded ends F/F, with red handle - with insulation extension - -5 Threads

Kugelhahn mit vollem Durchgang - IG/IG, mit rotem Hebelgriff - mit Isolierungsverlängerung

Vanne à boisseau sphérique à passage intégral - fixations F/F, avec poignée rouge - avec rallonge pour l'isolation

Полнопроходной шаровой кран - Соединения В/В, с красной ручкой - с удлинителем для изоляции



Cod./Code	Mis./Size	Ø	H (mm)	□/田	€
195405807	1/2"	15	87	15/60	16,71
195407807	3/4"	20	91	12/48	19,60
195410807	1"	25	104	12/48	27,97
195412807	1"1/4	32	109	6/24	37,10
195415807	1"1/2	40	127	4/16	53,08
195420807	2"	50	135	2/8	72,96



## IVR 58



Valvola a sfera a passaggio totale - attacchi tubo rame a compressione  
Full bore ball valve with compression ends for copper pipe  
Kugelhahn mit vollem Durchgang - mit Kompression-Anschlüssen für Kupferrohr  
Vanne à boisseau sphérique à passage intégral avec fixation tube en cuivre à compression  
Полнопроходной шаровой кран - компрессионные соединения для медной трубы

Cod./Code	DN	Ø	□/田	€
105815307	15	15	20/80	9,89
105822307	22	20	20/80	15,01
105828307	28	25	10/40	23,02
105835357	35	32	4/16	44,54
105842357	42	40	4/16	71,37
105854357	54	50	2/8	111,32



## IVR 58/A



Valvola a sfera a passaggio totale - attacchi tubo rame a compressione  
Full bore ball valve with compression ends for copper pipe with butterfly handle  
Kugelhahn mit vollem Durchgang - mit Kompression-Anschlüssen für Kupferrohr  
Vanne à boisseau sphérique à passage intégral avec fixation tube en cuivre à compression  
Полнопроходной шаровой кран - компрессионные соединения для медной трубы

Cod./Code	DN	Ø	□/田	€
105815302	15	15	20/80	9,89
105822302	22	20	20/80	15,01
105828302	28	25	10/40	23,02



### ACCESSORI / RICAMBI - ACCESSORIES / SPARE PARTS

											
1/4"	700702001	700101001	700105001	700102001	703001501	703005001	703002001	750106001	125603440	125603600	109702030
3/8"	700702001	700101001	700105001	700102001	703001501	703005001	703002001	750106001	125603440	125603600	109702030
1/2"	700702001	700411001	700415001	700412001	703001501	703005001	703002001	750106001	125603440	125603600	109702030
3/4"	700702001	700411001	700415001	700412001	703001501	703005001	703002001	750106001	125603440	125603600	109702030
1"	700712001	700421001	700425001	700422001	703011501	703015001	703012001	750108001	125605440	125605600	109705030
1"1/4	700712001	700421001	700425001	700422001				750108001	125605440	125605600	109705030
1"1/2	700722001	700431001	700435001	700432001				750110001	125610440	125610600	109710030
2"	700722001	700431001	700435001	700432001				750110001	125610440	125610600	109710030
2"1/2		700441001	700445001	700442001				750116001			109720010
3"		700441001	700445001	700442001				750116001			109720010
4"		700151001	700155001	700152001				750118001			109725010

Prezzi indicati nella sezione Accessori/Ricambi a fine capitolo / Prices in section Accessories/Spare Parts at the end of this chapter

## IVR EVERMID

40 bar



Max  
+150°  
Min  
-10°



UNI ISO 228-1

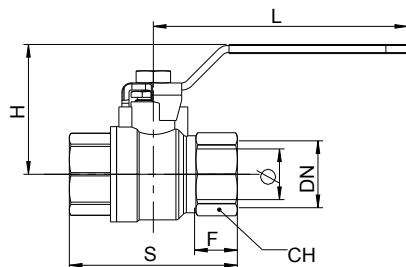

**IVR 918**

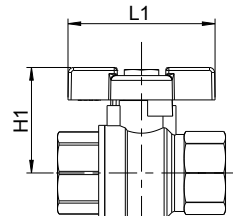

**IVR 918/A**

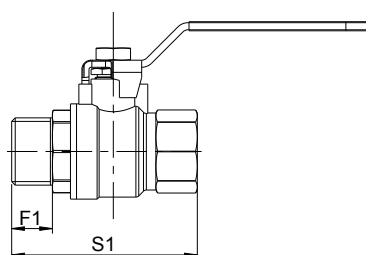

**IVR 919**

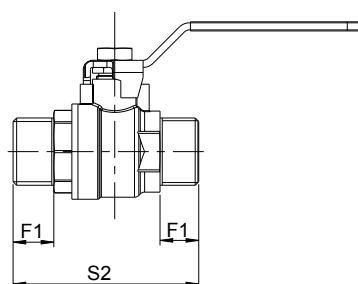

**IVR 920**

DIMENSIONI / DIMENSIONS

DN	Ø	S	S1	S2	L	L1	H	H1	F	F1	CH
1/2"	14	46	53	53	80	50	43	36	11	10	24
3/4"	18	52	58	58	80	50	45	39	11,5	11	30
1"	23	62	68		115	61	58	45	13,5	13	36
1"1/4	29	74	82		115		62		16	15	46
1"1/2	37	87	96		150		74		16,5	16	52
2"	47	98	107		150		81		17	17	65
2"1/2	50	109			140		85		20		83
3"	61	129			220		116		24		96
4"	74	148			220		116		27		121

## IVR 918



Valvola a sfera a passaggio standard - attacchi F/F, con maniglia rossa  
Standard bore ball valve - threaded ends F/F, with red handle -5 Threads  
Kugelhahn mit Standarddurchgang - IG/IG, mit rotem Hebelgriff  
Vanne à boisseau sphérique à passage normal - fixations F/F, avec poignée rouge  
Шаровой кран со стандартным проходом - соединения В/В, с красной ручкой

Cod./Code	Mis./Size	Ø	□/田	€
191805007	1/2"	14	20/120	6,31
191807007	3/4"	18	20/80	8,56
191810007	1"	23	12/48	13,64
191812007	1"1/4	30	8/32	22,48
191815007	1"1/2	37	6/24	34,11
191820007	2"	47	4/16	52,93
191825007	2"1/2	50	1/12	87,16
191830007	3"	61	1/6	137,77
191840007	4"	74	1/6	204,80



## IVR 918 LB



Valvola a sfera a passaggio standard - attacchi F/F, con maniglia blu  
Standard bore ball valve - threaded ends F/F, with blue handle -5 Threads  
Kugelhahn mit Standarddurchgang - IG/IG, mit blauem Hebelgriff  
Vanne à boisseau sphérique à passage normal - fixations F/F, avec poignée bleu  
Шаровой кран со стандартным проходом - соединения В/В, с голубой ручкой

Cod./Code	Mis./Size	Ø	□/田	€
191805209	1/2"	14	20/120	6,31
191807209	3/4"	18	20/80	8,56
191810209	1"	23	12/48	13,64
191812209	1"1/4	30	8/32	22,48
191815209	1"1/2	37	6/24	34,11
191820209	2"	47	4/16	52,93
191825209	2"1/2	50	1/12	87,16
191830209	3"	61	1/6	137,77
191840209	4"	74	1/6	204,80



## IVR 918 LN



Valvola a sfera a passaggio standard - attacchi F/F, con maniglia nera  
Standard bore ball valve - threaded ends F/F, with black handle -5 Threads  
Kugelhahn mit Standarddurchgang - IG/IG, mit schwarzem Hebelgriff  
Vanne à boisseau sphérique à passage normal - fixations F/F avec poignée noire  
Шаровой кран со стандартным проходом - соединения В/В, с чёрной ручкой

Cod./Code	Mis./Size	Ø	□/田	€
191805219	1/2"	14	20/120	6,31
191807219	3/4"	18	20/80	8,56
191810219	1"	23	12/48	13,64
191812219	1"1/4	30	8/32	22,48
191815219	1"1/2	37	6/24	34,11
191820219	2"	47	4/16	52,93
191825219	2"1/2	50	1/12	87,16
191830219	3"	61	1/6	137,77
191840219	4"	74	1/6	204,80



## IVR 918/A



Valvola a sfera a passaggio standard - attacchi F/F, con farfalla rossa  
Standard bore ball valve - threaded ends F/F, with red butterfly handle -5 Threads  
Kugelhahn mit Standarddurchgang - IG/IG, mit rotem Flügelgriff  
Vanne à boisseau sphérique à passage normal - fixations F/F, avec papillon rouge  
Шаровой кран со стандартным проходом - соединения В/В, с красной ручкой "бабочка"

Cod./Code	Mis./Size	Ø	□/田	€
191805008	1/2"	14	20/120	6,31
191807008	3/4"	18	20/80	8,56
191810008	1"	23	12/48	13,64



## IVR 918/A FB



Valvola a sfera a passaggio standard - attacchi F/F, con farfalla blu  
Standard bore ball valve - threaded ends F/F, with blue butterfly handle -5 Threads  
Kugelhahn mit Standarddurchgang - IG/IG, mit blauem Flügelgriff  
Vanne à boisseau sphérique à passage normal - fixations F/F, avec papillon bleu  
Шаровой кран со стандартным проходом - соединения В/В, с голубой ручкой "бабочка"

Cod./Code	Mis./Size	Ø	□/田	€
191805211	1/2"	14	20/120	6,31
191807211	3/4"	18	20/80	8,56
191810211	1"	23	12/48	13,64



## IVR 918/A FN



Valvola a sfera a passaggio standard - attacchi F/F, con farfalla nera  
Standard bore ball valve - threaded ends F/F, with black butterfly handle -5 Threads  
Kugelhahn mit Standarddurchgang - IG/IG, mit schwarzem Flügelgriff  
Vanne à boisseau sphérique à passage normal - fixations F/F, avec papillon noire  
Шаровой кран со стандартным проходом - соединения В/В, с чёрной ручкой "бабочка"

Cod./Code	Mis./Size	Ø	□/田	€
191805335	1/2"	14	20/120	6,31
191807335	3/4"	18	20/80	8,56
191810335	1"	23	12/48	13,64



## IVR 919



Valvola a sfera a passaggio standard - attacchi M/F, con maniglia rossa  
Standard bore ball valve - threaded ends M/F, with red handle -5 Threads  
Kugelhahn mit Standarddurchgang - AG/IG, mit rotem Hebelgriff  
Vanne à boisseau sphérique à passage normal - fixations M/F, avec poignée rouge  
Шаровой кран со стандартным проходом - соединения Н/В, с красной ручкой

Cod./Code	Mis./Size	Ø	□/⊕	€
191905007	1/2"	14	20/120	6,74
191907007	3/4"	18	20/80	9,00
191910007	1"	23	12/48	14,55
191912007	1"1/4	30	8/32	24,72
191915007	1"1/2	37	6/24	35,61
191920007	2"	47	4/16	55,96



## IVR 919 LB



Valvola a sfera a passaggio standard - attacchi M/F, con maniglia blu  
Standard bore ball valve - threaded ends M/F, with blue handle -5 Threads  
Kugelhahn mit Standarddurchgang - AG/IG, mit blauem Hebelgriff  
Vanne à boisseau sphérique à passage normal - fixations M/F, avec poignée bleu  
Шаровой кран со стандартным проходом - соединения Н/В, с голубой ручкой

Cod./Code	Mis./Size	Ø	□/⊕	€
191905209	1/2"	14	20/120	6,74
191907209	3/4"	18	20/80	9,00
191910209	1"	23	12/48	14,55
191912209	1"1/4	30	8/32	24,72
191915209	1"1/2	37	6/24	35,61
191920209	2"	47	4/16	55,96



## IVR 919 LN



Valvola a sfera a passaggio standard - attacchi M/F con maniglia nera  
Standard bore ball valve - threaded ends M/F, with black handle -5 Threads  
Kugelhahn mit Standarddurchgang - AG/IG, mit schwarzem Hebelgriff  
Vanne à boisseau sphérique à passage normal - fixations M/F avec poignée noire  
Шаровой кран со стандартным проходом, соединения Н/В, с черной ручкой.

Cod./Code	Mis./Size	Ø	□/⊕	€
191905219	1/2"	14	20/120	6,74
191907219	3/4"	18	20/80	9,00
191910219	1"	23	12/48	14,55
191912219	1"1/4	30	8/32	24,72
191915219	1"1/2	37	6/24	35,61
191920219	2"	47	4/16	55,96





## IVR 919/A



Valvola a sfera a passaggio standard - attacchi M/F, con farfalla rossa  
Standard bore ball valve - threaded ends M/F, with red butterfly handle -5 Threads  
Kugelhahn mit Standarddurchgang - AG/IG, mit rotem Flügelgriff  
Vanne à boisseau sphérique à passage normal - fixations M/F, avec papillon rouge  
Шаровой кран со стандартным проходом - соединения Н/В, с красной ручкой "бабочка"

Cod./Code	Mis./Size	Ø	□/田	€
191905008	1/2"	14	20/120	6,74
191907008	3/4"	18	20/80	9,00
191910008	1"	23	12/48	14,55



## IVR 919/A FB



Valvola a sfera a passaggio standard - attacchi M/F, con farfalla blu  
Standard bore ball valve - threaded ends M/F, with blue butterfly handle -5 Threads  
Kugelhahn mit Standarddurchgang - AG/IG, mit blauem Flügelgriff  
Vanne à boisseau sphérique à passage normal - fixations M/F, avec papillon bleu  
Шаровой кран со стандартным проходом - соединения Н/В, с голубой ручкой "бабочка"

Cod./Code	Mis./Size	Ø	□/田	€
191905211	1/2"	14	20/120	6,74
191907211	3/4"	18	20/80	9,00
191910211	1"	23	12/48	14,55



## IVR 919/A FN



Valvola a sfera a passaggio standard - attacchi M/F, con farfalla nera  
Standard bore ball valve - threaded ends M/F, with black butterfly handle -5 Threads  
Kugelhahn mit Standarddurchgang - AG/IG, mit schwarzem Flügelgriff  
Vanne à boisseau sphérique à passage normal - fixations M/F, avec papillon noire  
Шаровой кран со стандартным проходом - соединения Н/В, с чёрной ручкой "бабочка"

Cod./Code	Mis./Size	Ø	□/田	€
191905335	1/2"	14	20/120	6,74
191907335	3/4"	18	20/80	9,00
191910335	1"	23	12/48	14,55



## IVR 920



Valvola a sfera a passaggio standard - attacchi M/M con maniglia rossa  
Standard bore ball valve - threaded ends M/M with red handle -5 Threads  
Kugelhahn mit Standarddurchgang - AG/AG, mit rotem Hebelgriff  
Vanne à boisseau sphérique à passage normal - fixations M/M avec poignée rouge  
Шаровой кран со стандартным проходом , соединения Н/Н, с красной ручкой.

Cod./Code	Mis./Size	Ø	□/田	€
192005007	1/2"	14	20/120	6,64
192007007	3/4"	18	20/80	9,07



## IVR 920/A



Valvola a sfera a passaggio standard - attacchi M/M con farfalla rossa  
Standard bore ball valve - threaded ends M/M with red butterfly handle -5 Threads  
Kugelhahn mit Standarddurchgang - AG/AG, mit rotem Flügelgriff  
Vanne à boisseau sphérique à passage normal - fixations M/M avec poignée papillon rouge  
Шаровой кран со стандартным проходом , соединения Н/Н, с красной ручкой "бабочка"

Cod./Code	Mis./Size	Ø	□/田	€
192005008	1/2"	14	20/120	6,64
192007008	3/4"	18	20/80	9,07



### ACCESSORI / RICAMBI - ACCESSORIES / SPARE PARTS

										
1/2"	700101001	700105001	700102001	703001501	703005001	703002001	750106001	125603440	125603600	109702030
3/4"	700101001	700105001	700102001	703001501	703005001	703002001	750106001	125603440	125603600	109702030
1"	700421001	700425001	700422001	703011501	703015001	703012001	750108001	125605440	125605600	109705030
1"1/4	700421001	700425001	700422001				750108001	125605440	125605600	109705030
1"1/2	700431001	700435001	700432001				750110001	125610440	125610600	109710030
2"	700431001	700435001	700432001				750110001	125610440	125610600	109710030
2"1/2	700131001	700135001	700132001				750114001			109715030
3"	700441001	700445001	700442001				750116001			109720010
4"	700441001	700445001	700442001				750116001			109720010

Prezzi indicati nella sezione Accessori/Ricambi a fine capitolo / Prices in section Accessories/Spare Parts at the end of this chapter

## VALVOLE BOCCHETTONE GLOBO VALVES GLOBO WITH TAIL PIECE

### IVR 60/A



Valvola a sfera a passaggio totale con bocchettone - M/F, sede conica, farfalla rossa - 3/4" disponibile anche con farfalla nera

Full bore ball valve with tail piece - M/F, conical seat, red butterfly handle - 3/4" available also with black blue butterfly handle

Kugelhahn mit vollem Durchgang und Rohrverschraubung - AG/IG, Kegelsitz und rotem Flügelgriff - 3/4" verfügbar auch mit schwarzem Flügelgriff

Vanne à boisseau sphérique à passage intégral avec raccord - M/F, siège conique, poignée papillon rouge - 3/4" disponible aussi avec poignée papillon noire

Полнопроходной шаровой кран со сгоном, соединение Н/В, с коническим седлом, красная ручка "бабочка" - 3/4" доступен также с чёрной ручкой "бабочка"

Cod./Code	Mis./Size	□/田	€
106005010	1/2"	10/120	9,72
106007010	3/4"	10/60	13,98
106010010	1"	10/40	23,69
106012010	1"1/4	6/24	35,77



### IVR 60/B



Valvola a sfera a passaggio totale con bocchettone - M/F, sede conica, farfalla blu

Full bore ball valve with tail piece - M/F, conical seat, blue butterfly handle

Kugelhahn mit vollem Durchgang und Rohrverschraubung - AG/IG, Kegelsitz und blauem Flügelgriff

Vanne à boisseau sphérique à passage intégral avec raccord - M/F, siège conique, poignée papillon bleue

Полнопроходной шаровой кран со сгоном, соединение Н/В, с коническим седлом, синяя ручка "бабочка"

Cod./Code	Mis./Size	□/田	€
106005311	1/2"	10/120	9,72
106007311	3/4"	10/60	13,98
106010311	1"	10/40	23,69
106012311	1"1/4	6/24	35,77



### IVR 60



Valvola a sfera a passaggio totale con bocchettone - M/F, sede conica, leva rossa

Full bore ball valve with tail piece - M/F, conical seat, red handle

Kugelhahn mit vollem Durchgang und Rohrverschraubung - AG/IG, Kegelsitz und roter Griff

Vanne à boisseau sphérique à passage intégral avec raccord - M/F, siège conique, poignée rouge

Полнопроходной шаровой кран со сгоном, соединение Н/В, с коническим седлом, красный рычаг

Cod./Code	Mis./Size	□/田	€
106005012	1/2"	12/72	9,72
106007012	3/4"	12/48	13,98
106010012	1"	10/40	23,69
106012012	1"1/4	6/24	35,77



### IVR 60 LB



Valvola a sfera a passaggio totale con bocchettone - M/F, sede conica, leva blu

Full bore ball valve with tail piece - M/F, conical seat, blue handle

Kugelhahn mit vollem Durchgang und Rohrverschraubung - AG/IG, Kegelsitz und blauem Griff

Vanne à boisseau sphérique à passage intégral avec raccord - M/F, siège conique, poignée bleue

Полнопроходной шаровой кран со сгоном, соединение Н/В, с коническим седлом, синий рычаг

Cod./Code	Mis./Size	□/田	€
106005312	1/2"	12/72	9,72
106007312	3/4"	12/48	13,98
106010312	1"	10/40	23,69
106012312	1"1/4	6/24	35,77



## IVR 961/A



Valvola a sfera a passaggio standard a squadra con bocchettone - M/F, sede conica, farfalla rossa - 3/4" disponibile anche con farfalla nera (Codice 196107235)

Angle standard bore ball valve with tail piece - M/F, conical seat, red butterfly handle - 3/4" available also with black butterfly handle (Item No. 196107235)

Kugelhahn mit Standarddurchgang, eckförmig, mit Rohrverschraubung - AG/IG, Kegelsitz und rotem Flügelgriff - 3/4" verfügbar auch mit schwarzem Flügelgriff (Artikel 196107235)

Vanne à boisseau sphérique équerre à passage standard avec raccord - M/F, siège conique, poignée papillon rouge - 3/4" Disponible aussi avec poignée papillon noire (article 196107235)

Угловой шаровой кран со стандартным проходом и сгоном, соединение Н/В, с коническим седлом, красная ручка "бабочка" - 3/4" доступен также с чёрной ручкой "бабочка" (Код. 196107235)

Cod./Code	Mis./Size	□/田	€
196105002	1/2"	20/80	12,73
196107002	3/4"	12/48	18,62
196110002	1"	6/24	30,75



## IVR 961/B



Valvola a sfera a passaggio standard a squadra con bocchettone - M/F, sede conica, farfalla blu

Angle standard bore ball valve with tail piece - M/F, conical seat, blue butterfly handle

Kugelhahn mit Standarddurchgang, eckförmig, mit Rohrverschraubung - AG/IG, Kegelsitz und blauem Flügelgriff

Vanne à boisseau sphérique équerre à passage standard avec raccord - M/F, siège conique, poignée papillon bleue

Угловой шаровой кран со стандартным проходом и сгоном, соединение Н/В, с коническим седлом, синяя ручка "бабочка"

Cod./Code	Mis./Size	□/田	€
196105311	1/2"	20/80	12,73
196107311	3/4"	12/48	18,62
196110311	1"	6/24	30,75



### ACCESSORI / RICAMBI - ACCESSORIES / SPARE PARTS

					
1/2"	703001501	703005001	700101001	700105001	750106001
3/4"	703001501	703005001	700101001	700105001	750106001
1"	703011501	703015001	700111001	700115001	750108001
1"1/4	703021501	703025001	700121001	700125001	750110001

Prezzi indicati nella sezione Accessori/Ricambi a fine capitolo / Prices in section Accessories/Spare Parts at the end of this chapter

## IVR ELITE GREEN WATER 4MS

50 bar

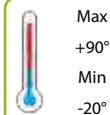

Max  
+90°  
Min  
-20°



UNI EN 10226-1  
(ISO 7-1 Rp)

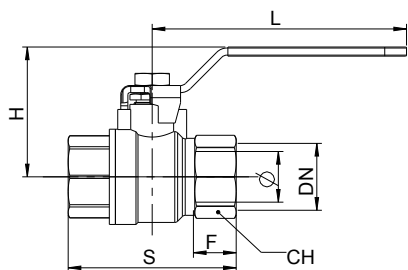

**IVR 100**

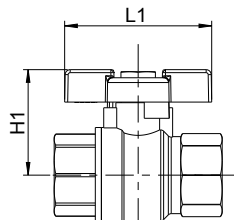

**IVR 100/A**

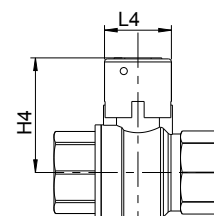

**IVR 120**

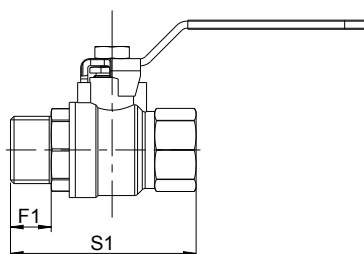

**IVR 101**

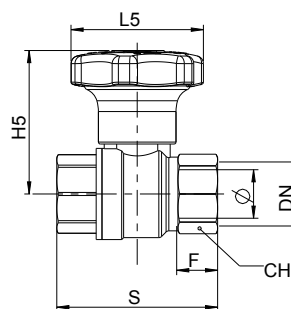

**IVR 137**

DIMENSIONI / DIMENSIONS

DN	Ø	S	S1	L	L1	L4	L5	H	H1	H4	H5	F	F1	CH
3/8"	10	45	54	80	50		70	41	33		59	12	12	21
1/2"	15	63	70	90	61	29	70	52	39	45	65	17	15	26
3/4"	20	71	80	90	61	29	70	55	43	49	68	19,5	15,6	31
1"	25	83	92	125	72	33	70	65		56	76	21	19	38
1"1/4	32	92	102	125		33	70	69		61	81	22	20,5	48
1"1/2	40	104	117	140		44	112	78		75	105	23,5	21,5	55
2"	50	124	137	140		44	112	85		82	112	28	24,5	68

## IVR 100 GW 4MS KIWA



Valvola a sfera a passaggio totale per acqua potabile - omologata KIWA - attacchi F/F  
Full bore ball valve for drinking water - KIWA certified - F/F - 7 Threads  
Kugelhahn mit vollem Durchgang für Trinkwasser - Zulassung KIWA - IG/IG  
Vanne à boisseau sphérique à passage intégral - certification KIWA - F/F  
Полнопроходной шаровой кран для питьевой воды- сертификат KIWA - соединения В/В

Cod./Code	Mis./Size	Ø	□/田	€
110003224	3/8"	10	10/120	7,01
110005224	1/2"	15	12/72	11,06
110007224	3/4"	20	15/60	14,09
110010224	1"	25	10/40	23,15



## IVR 101 GW 4MS KIWA



Valvola a sfera a passaggio totale per acqua potabile - omologata KIWA - attacchi M/F  
Full bore ball valve for drinking water - KIWA certified - M/F - 7 Threads  
Kugelhahn mit vollem Durchgang für Trinkwasser - Zulassung KIWA - AG/IG  
Vanne à boisseau sphérique à passage intégral - certification KIWA - M/F  
Полнопроходной шаровой кран для питьевой воды - сертификат KIWA - соединения Н/В

Cod./Code	Mis./Size	Ø	□/田	€
110103224	3/8"	10	10/120	6,89
110105224	1/2"	15	12/72	11,56
110107224	3/4"	20	15/60	15,01
110110224	1"	25	10/40	24,20



## IVR 208 GW 4MS KIWA



Valvola a sfera a passaggio totale per acqua potabile con spurgo - omologata KIWA - attacchi F/F  
Full bore ball valve for drinking water with drain - KIWA certified - F/F - 7 Threads  
Kugelhahn mit vollem Durchgang für Trinkwasser mit Ablasshahn - Zulassung KIWA - IG/IG  
Vanne à boisseau sphérique à passage intégral pour eau potable avec robinet d'évacuation- certification KIWA - F/F  
Полнопроходной шаровой кран для питьевой воды со спускным краном - сертификат KIWA - соединения В/В

Cod./Code	Mis./Size	Ø	□/田	€
120805224	1/2"	15	10/60	14,65
120807224	3/4"	20	15/60	17,73
120810224	1"	25	10/40	27,48
120812227	1"1/4	32	6/24	41,67
120815227	1"1/2	40	2/8	65,80
120820227	2"	50	2/8	102,07





## IVR 100 GW 4MS



Valvola a sfera a passaggio totale per acqua potabile - Antilegionella, antigelo - attacchi F/F  
Full bore ball valve for drinking water - anti-legionella and anti-freeze - threaded ends F/F - 7 Threads  
Kugelhahn mit vollem Durchgang - Antilegionellenfunktion - für Trinkwasser - IG/IG  
Vanne à boisseau sphérique à passage intégral pour eau potable - anti-légionelle, antigel - fixations F/F  
Полнопроходной шаровой кран для питьевой воды - конструкция "антилегионелла", с защитой от замерзания, соединения В/В

Cod./Code	Mis./Size	Ø	□/田	€
110003200	3/8"	10	10/120	5,50
110005200	1/2"	15	12/72	9,03
110007200	3/4"	20	15/60	12,11
110010200	1"	25	10/40	20,36
110012200	1"1/4	32	6/24	30,33
110015200	1"1/2	40	4/16	47,77
110020200	2"	50	2/8	71,79



## IVR 100/A GW 4MS



Valvola a sfera a passaggio totale per acqua potabile - Antilegionella, antigelo - attacchi F/F  
Full bore ball valve for drinking water - anti-legionella and anti-freeze - threaded ends F/F - 7 Threads  
Kugelhahn mit vollem Durchgang - Antilegionellenfunktion - für Trinkwasser - IG/IG  
Vanne à boisseau sphérique à passage intégral pour eau potable - anti-légionelle, antigel - fixations F/F  
Полнопроходной шаровой кран для питьевой воды - конструкция "антилегионелла", с защитой от замерзания, соединения В/В

Cod./Code	Mis./Size	Ø	□/田	€
110003201	3/8"	10	10/120	5,50
110005201	1/2"	15	12/72	9,03
110007201	3/4"	20	15/60	12,11
110010201	1"	25	10/40	20,36



## IVR 101 GW 4MS



Valvola a sfera a passaggio totale per acqua potabile - Antilegionella, antigelo - attacchi M/F  
Full bore ball valve for drinking water - anti-legionella and anti-freeze - threaded ends M/F - 7 Threads  
Kugelhahn mit vollem Durchgang-Antilegionellenfunktion - für Trinkwasser - AG/IG  
Vanne à boisseau sphérique à passage intégral pour eau potable - anti-légionelle, antigel - fixations M/F  
Полнопроходной шаровой кран для питьевой воды - конструкция "антилегионелла", с защитой от замерзания, соединения Н/В

Cod./Code	Mis./Size	Ø	□/田	€
110103200	3/8"	10	10/120	5,66
110105200	1/2"	15	12/72	9,53
110107200	3/4"	20	15/60	13,05
110110200	1"	25	10/40	21,40
110112200	1"1/4	32	6/24	33,14
110115200	1"1/2	40	4/16	52,35
110120200	2"	50	2/8	75,48



## IVR 101/A GW 4MS



Valvola a sfera a passaggio totale per acqua potabile - Antilegionella, antigelo - attacchi M/F  
Full bore ball valve for drinking water - anti-legionella and anti-freeze - threaded ends M/F - 7 Threads  
Kugelhahn mit vollem Durchgang-Antilegionellenfunktion - für Trinkwasser - AG/IG  
Vanne à boisseau sphérique à passage intégral pour eau potable - anti-légionelle, antigel - fixations M/F  
Полнопроходной шаровой кран для питьевой воды - конструкция "антилегионелла", с защитой от замерзания, соединения Н/В

Cod./Code	Mis./Size	Ø	□/田	€
110103201	3/8"	10	10/120	5,66
110105201	1/2"	15	12/72	9,53
110107201	3/4"	20	15/60	13,05
110110201	1"	25	10/40	21,40



## IVR 208 GW 4MS



Valvola a sfera a passaggio totale per acqua potabile - antilegionella, antigelo - con rubinetto di scarico - attacchi F/F

Full bore ball valve for drinking water - anti-legionella and anti-freeze - with drain valve threaded ends F/F - 7 Threads

Kugelhahn mit vollem Durchgang und Ablasshahn - Antilegionellenfunktion - Für Trinkwasser - IG/IG

Vanne à boisseau sphérique à passage intégral pour eau potable - anti-légionelle, antigel - avec robinet de vidange - fixations F/F

Полнопроходной шаровой кран для питьевой воды - конструкция "антилегионелла" с защитой от замерзания - со спускным краном - соединения В/В.

Cod./Code	Mis./Size	Ø	□/⊞	€
120805215	1/2"	15	10/40	16,13
120807215	3/4"	20	15/60	19,27
120810215	1"	25	10/40	27,38
120812215	1"1/4	32	6/24	36,63
120815215	1"1/2	40	4/16	58,71
120820215	2"	50	2/8	93,98



## IVR 208/A GW 4MS



Valvola a sfera a passaggio totale per acqua potabile - antilegionella, antigelo - con rubinetto di scarico - attacchi F/F

Full bore ball valve for drinking water - anti-legionella and anti-freeze - with drain valve threaded ends F/F - 7 Threads

Kugelhahn mit vollem Durchgang und Ablasshahn - Antilegionellenfunktion - Für Trinkwasser - IG/IG

Vanne à boisseau sphérique à passage intégral pour eau potable - anti-légionelle, antigel - avec robinet de vidange - fixations F/F

Полнопроходной шаровой кран для питьевой воды - конструкция "антилегионелла" с защитой от замерзания - со спускным краном - соединения В/В.

Cod./Code	Mis./Size	Ø	□/⊞	€
120805216	1/2"	15	10/40	16,13
120807216	3/4"	20	20/80	19,27
120810216	1"	25	10/40	27,38
120812216	1"1/4	32	6/24	36,63



## IVR 137 GW 4MS



Valvola a sfera a passaggio totale per acqua potabile - antilegionella, antigelo - con riduttore di manovra - attacchi F/F

Full bore ball valve for drinking water - anti-legionella and anti-freeze - with 360° handle threaded ends F/F - 7 Threads

Kugelhahn mit vollem Durchgang und Getriebe - Antilegionellenfunktion - für Trinkwasser - IG/IG

Vanne à boisseau sphérique à passage intégral pour eau potable - anti-légionelle, antigel - avec réducteur de manoeuvre - fixations F/F

Полнопроходной шаровой кран для питьевой воды - конструкция "антилегионелла" с защитой от замерзания - с редуктором управления - соединения В/В.

Cod./Code	Mis./Size	Ø	□/⊞	€
113703200	3/8"	10	12/48	14,74
113705200	1/2"	15	9/36	17,03
113707200	3/4"	20	8/32	20,20
113710200	1"	25	8/32	28,62
113712200	1"1/4	32	6/24	38,79
113715200	1"1/2	40	2/8	60,03
113720200	2"	50	2/8	84,52



## IVR 157 GW 4MS



Valvola a sfera a passaggio totale per acqua potabile - antilegionella, antigelo - con riduttore di manovra - attacchi M/F

Full bore ball valve for drinking water - anti-legionella and anti-freeze - with 360° handle threaded ends M/F - 7 Threads

Kugelhahn mit vollem Durchgang und Getriebe - Antilegionellenfunktion - für Trinkwasser - AG/IG

Vanne à boisseau sphérique à passage intégral pour eau potable - anti-légionelle, antigel - avec réducteur de manoeuvre - fixations M/F

Полнопроходной шаровой кран для питьевой воды - конструкция "антилегионелла" с защитой от замерзания - с редуктором управления - соединения Н/В



Cod./Code	Mis./Size	Ø	□/田	€
115703200	3/8"	10	15/60	13,84
115705200	1/2"	15	9/36	17,32
115707200	3/4"	20	8/32	20,94
115710200	1"	25	8/32	29,08
115712200	1"1/4	32	6/24	41,42
115715200	1"1/2	40	2/8	64,31
115720200	2"	50	2/8	88,40



## IVR 120 GW 4MS



Valvola a sfera a passaggio totale per acqua potabile - Antilegionella, antigelo con cappuccio sigillabile - attacchi F/F

Full bore ball valve for drinking water - anti-legionella and anti-freeze - with sealing cap ends F/F - 7 Threads

Kugelhahn mit vollem Durchgang - Antilegionellenfunktion - für Trinkwasser mit abdichtbarer Kappe - IG/IG

Vanne à boisseau sphérique à passage intégral pour eau potable - anti-légionelle, antigel - avec capuchon scellable - fixations F/F

Полнопроходной шаровой кран для питьевой воды - конструкция "антилегионелла" с защитой от замерзания - с колпачком под пломбировку - соединения В/В



Cod./Code	Mis./Size	Ø	□/田	€
112005200	1/2"	15	10/60	12,20
112007200	3/4"	20	15/60	15,01
112010200	1"	25	10/40	21,76
112012200	1"1/4	32	6/24	31,53
112015200	1"1/2	40	5/20	48,07
112020200	2"	50	2/8	74,61



## IVR 121 GW 4MS



Valvola a sfera a passaggio totale per acqua potabile - Antilegionella, antigelo con cappuccio sigillabile - attacchi M/F

Full bore ball valve for drinking water - anti-legionella and anti-freeze - with sealing cap ends M/F - 7 Threads

Kugelhahn mit vollem Durchgang - Antilegionellenfunktion-für Trinkwasser mit abdichtbarer Kappe - AG/IG

Vanne à boisseau sphérique à passage intégral pour eau potable - anti-légionelle, antigel - avec capuchon scellable - fixations M/F

Полнопроходной шаровой кран для питьевой воды - конструкция "антилегионелла" с защитой от замерзания - с колпачком под пломбировку - соединения Н/В



Cod./Code	Mis./Size	Ø	□/田	€
112105200	1/2"	15	10/60	12,38
112107200	3/4"	20	15/60	16,14
112110200	1"	25	10/40	22,60
112112200	1"1/4	32	6/24	35,23
112115200	1"1/2	40	5/20	52,12
112120200	2"	50	2/8	78,11



### ACCESSORI / RICAMBI - ACCESSORIES / SPARE PARTS

3/8"	700107001	703007001	750106001	707007001		109702030
1/2"	700117001	703017001	750108001	707017001	706017000	109705030
3/4"	700117001	703017001	750108001	707017001	706017000	109705030
1"	700127001	703027001	750110001	707027001	706027000	109710030
1"1/4	700127001	703027001	750110001	707027001	706027000	109710030
1"1/2	700137001		750114001	707037001	706037000	109715030
2"	700137001		750114001	707037001	706037000	109715030

Prezzi indicati nella sezione Accessori/Ricambi a fine capitolo / Prices in section Accessories/Spare Parts at the end of this chapter

## IVR QUADRO

### IVR 42



Valvola a sfera a passaggio totale - Antilegionella - quadro di manovra 28mm - attacchi F/F  
 Full bore ball valve - anti-legionella - square cap 28mm - threaded ends F/F - 7 Threads  
 Kugelhahn mit vollem Durchgang - Antilegionellenfunktion - Schalttafel 28 mm - IG/IG  
 Vanne à boisseau sphérique à passage intégral - anti-légionelle - tableau de manoeuvre 28mm - fixations F/F  
 Полнопроходной шаровой кран - антилегионелла - с квадратной головкой для управления 28 мм - соединения В/В

Cod./Code	Mis./Size	Ø	□/⊕	€
104205285	1/2"	15	10/60	15,45
104207285	3/4"	20	10/40	18,91
104210285	1"	25	10/40	26,40
104212285	1"1/4	32	6/24	36,04
104215285	1"1/2	40	5/20	53,77
104220285	2"	50	2/8	79,69



### IVR 43



Valvola a sfera a passaggio totale - Antilegionella - quadro di manovra 28mm - attacchi M/F  
 Full bore ball valve - anti-legionella - square cap 28mm - threaded ends M/F - 7 Threads  
 Kugelhahn mit vollem Durchgang - Antilegionellenfunktion - Schalttafel 28 mm - AG/IG  
 Vanne à boisseau sphérique à passage intégral - anti-légionelle - tableau de manoeuvre 28mm - fixations M/F  
 Полнопроходной шаровой кран - антилегионелла - с квадратной головкой для управления 28 мм - соединения Н/В

Cod./Code	Mis./Size	Ø	□/⊕	€
104305285	1/2"	15	10/60	15,75
104307285	3/4"	20	10/40	19,53
104310285	1"	25	10/40	27,36
104312285	1"1/4	32	6/24	38,48
104315285	1"1/2	40	5/20	58,12
104320285	2"	50	2/8	83,64



## IVR SOLAR LINE

50 bar

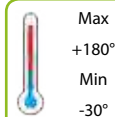

Max  
+180°  
Min  
-30°

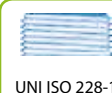

UNI ISO 228-1

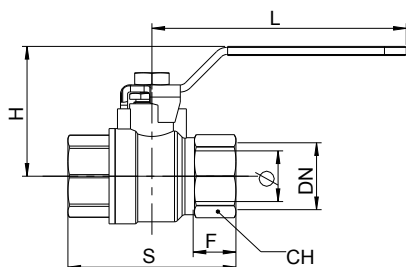

**IVR 440**

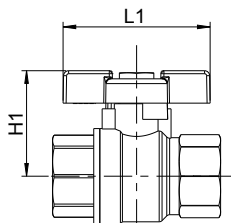

**IVR 440/A**

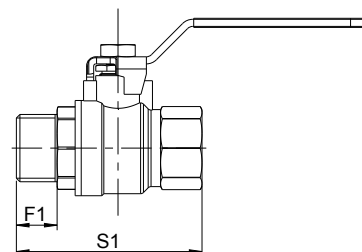

**IVR 441**

### DIMENSIONI / DIMENSIONS

DN	Ø	S	S1	L	L1	H	H1	F	F1	CH
3/8"	10	45	54	80	50	40	33	12	12	21
1/2"	15	63	70	90	61	52	39	17	15	26
3/4"	20	71	80	90	61	55	43	19,5	16	31
1"	25	83	92	125	72	64	52	21	19	38
1"1/4	32	92	102	125		69	57	22	20,5	48
1"1/2	40	104	117	140		78		23,5	21,5	55
2"	50	124	137	140		85		28	24,5	68

## IVR 440



Valvola a sfera a passaggio totale - SOLAR LINE - attacchi F/F  
Full bore ball valve SOLAR LINE - threaded ends F/F - 7 Threads  
Kugelhahn mit vollem Durchgang - SOLAR LINE - IG/IG  
Vanne à boisseau sphérique à passage intégral SOLAR LINE - fixations F/F  
Полнопроходной шаровой кран - SOLAR LINE - соединения В/В

Cod./Code	Mis./Size	Ø	□/田	€
144003007	3/8"	10	10/60	7,78
144005007	1/2"	15	12/48	10,71
144007007	3/4"	20	12/48	14,01
144010007	1"	25	8/32	22,54
144012007	1"1/4	32	6/24	33,27
144015007	1"1/2	40	4/16	50,54
144020007	2"	50	2/8	76,38



## IVR 440/A



Valvola a sfera a passaggio totale - SOLAR LINE - attacchi F/F  
Full bore ball valve SOLAR LINE - threaded ends F/F - 7 Threads  
Kugelhahn mit vollem Durchgang - SOLAR LINE - IG/IG  
Vanne à boisseau sphérique à passage intégral SOLAR LINE - fixations F/F  
Полнопроходной шаровой кран - SOLAR LINE - соединения В/В

Cod./Code	Mis./Size	Ø	□/田	€
144003008	3/8"	10	10/60	7,78
144005008	1/2"	15	12/48	10,71
144007008	3/4"	20	12/48	14,01
144010008	1"	25	8/32	22,54



## IVR 441



Valvola a sfera a passaggio totale - SOLAR LINE - attacchi M/F  
Full bore ball valve SOLAR LINE - threaded ends M/F - 7 Threads  
Kugelhahn mit vollem Durchgang - SOLAR LINE - AG/IG  
Vanne à boisseau sphérique à passage intégral SOLAR LINE - fixations M/F  
Полнопроходной шаровой кран - SOLAR LINE - соединения H/B

Cod./Code	Mis./Size	Ø	□/田	€
144103007	3/8"	10	10/60	8,04
144105007	1/2"	15	12/48	11,11
144107007	3/4"	20	12/48	14,60
144110007	1"	25	8/32	23,59
144112007	1"1/4	32	4/16	38,52
144115007	1"1/2	40	4/16	54,41
144120007	2"	50	2/8	80,16



## IVR 441/A





Valvola a sfera a passaggio totale - SOLAR LINE - attacchi M/F  
Full bore ball valve SOLAR LINE - threaded ends M/F - 7 Threads  
Kugelhahn mit vollem Durchgang - SOLAR LINE - AG/IG  
Vanne à boisseau sphérique à passage intégral SOLAR LINE - fixations M/F  
Полнопроходной шаровой кран - SOLAR LINE - соединения H/B

Cod./Code	Mis./Size	Ø	□/田	€
144103008	3/8"	10	10/60	8,04
144105008	1/2"	15	12/48	11,11
144107008	3/4"	20	12/48	14,60
144110008	1"	25	8/32	23,59



### ACCESSORI / RICAMBI - ACCESSORIES / SPARE PARTS

	3/8"	1/2"	3/4"	1"	1"1/4	1"1/2	2"
	701604001	701614001	701614001	701624001	701624001	701634001	701634001
	703004001	703014001	703014001	703024001			
	750306001	750308001	750308001	750310001	750310001	750314001	750314001

Prezzi indicati nella sezione Accessori/Ricambi a fine capitolo / Prices in section Accessories/Spare Parts at the end of this chapter

## IVR 442



Valvola automatica sfiato aria  
Automatic air-vent valve for solar system  
Automatisches Entlüftungsventil  
Vanne automatique de purge d'air  
Автоматический воздухоотводчик

Cod./Code	Mis./Size	Ø	□/田	€
144203001	3/8"	10	8/48	14,80
144205001	1/2"	15	8/48	14,81



## IVR 443



Valvola sicurezza F/F  
Safety valve F/F for solar system  
Sicherheitsventil, IG/IG  
Groupe de sécurité F/F  
Предохранительный клапан В/В

Cod./Code	Mod./Model	Mis./Size	Ø	□/田	€
144305301	3,0 bar	1/2" x 3/4"	10	10/60	23,36
144305401	4,0 bar	1/2" x 3/4"	15	10/60	23,36
144305601	6,0 bar	1/2" x 3/4"	20	10/60	23,36





## IVR 759



Valvola miscelatrice termostatica a 3 vie per impianti solari - attacchi F/F/F  
3-way thermostatic mixing valve for solar systems - F/F/F  
3-Wege thermostatisches Mischventil für Solaranlagen - IG/IG/IG  
Soupape de mélange à 3 voies thermostatique pour systèmes solaires - F/F/F  
3-ходовой термостатический смесительный клапан для солнечных систем - соединения В/В/В

Cod./Code	Mis./Size	□/田	€
175905001	1/2"	1/15	97,10
175907001	3/4"	1/15	97,10
175910001	1"	1/15	101,18



## IVR 760



Valvola miscelatrice termostatica a 3 vie per impianti solari - attacchi M/M/M  
3-way thermostatic mixing valve for solar systems - M/M/M  
3-Wege thermostatisches Mischventil für Solaranlagen - AG/AG/AG  
Soupape de mélange à 3 voies thermostatique pour systèmes solaires - M/M/M  
3-ходовой термостатический смесительный клапан для солнечных систем - соединения Н/Н/Н

Cod./Code	Mis./Size	□/田	€
176007001	3/4"	1/15	116,31
176010001	1"	1/15	123,79



## IVR 760 K1



KIT Termostatico di collegamento Solare-Caldaia - 3/4" - Kvs 1,2  
Thermostatic KIT for Solar-Boiler connection - 3/4" - Kvs 1,2  
Thermostat-KIT für Solar-Kessel-Anschluss - 3/4" - Kvs 1,2  
KIT thermostatique pour raccordement solaire-chaudière - 3/4" - Kvs 1,2  
Термостатический КОМПЛЕКТ для подключения солнечного котла - 3/4" - Kvs 1,2

Cod./Code	Mis./Size	□/田	€
176007011	3/4"	1/3	354,98



## IVR 760 K2



KIT Termostatico di collegamento Solare-Caldaia con temperatura di deviazione regolabile - 3/4" - Kvs 1,7  
Solar-Boiler connection thermostatic KIT with adjustable deviation temperature - 3/4" - Kvs 1.7  
Thermostat-KIT mit Solar-Kessel-Anschluss und einstellbarer Abweichungstemperatur - 3/4" - Kvs 1.7  
KIT thermostatique de raccordement solaire-chaudière avec déviation de température réglable - 3/4" - Kvs 1,7  
Термостатический КОМПЛЕКТ для подключения солнечного котла с регулируемой температурой отклонения - 3/4" - Kvs 1,7

Cod./Code	Mis./Size	□/田	€
176007022	3/4"	1/3	497,98



## IVR NPT



50 bar

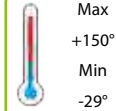

Max  
+150°  
Min  
-29°



NPT ANSI  
B.1.20-1



## IVR 45/A NPT



Valvola a sfera a passaggio totale - attacchi F/F NPT  
Full bore ball valve - threaded ends F/F NPT - 7 Threads  
Kugelhahn mit vollem Durchgang - IG/IG NPT  
Vanne à boisseau sphérique à passage intégral - fixations F/F avec filetage NPT  
Полнопроходной шаровой кран - соединения В/В NPT

Cod./Code	Mis./Size	Ø	□/田	€
104502089	1/4"	10	10/120	6,05
104503089	3/8"	10	10/120	5,43
104505089	1/2"	15	12/72	9,30
104507089	3/4"	20	15/60	12,87
104510089	1"	25	10/40	20,90



## IVR 45 NPT



Valvola a sfera a passaggio totale - attacchi F/F NPT  
Full bore ball valve - threaded ends F/F NPT - 7 Threads  
Kugelhahn mit vollem Durchgang - IG/IG NPT  
Vanne à boisseau sphérique à passage intégral - fixations F/F avec filetage NPT  
Полнопроходной шаровой кран - соединения В/В NPT

Cod./Code	Mis./Size	Ø	□/田	€
104502090	1/4"	10	10/120	6,05
104503090	3/8"	10	10/120	5,43
104505090	1/2"	15	20/80	9,30
104507090	3/4"	20	12/48	12,87
104510090	1"	25	10/40	20,90
104512090	1"1/4	32	5/20	30,78
104515090	1"1/2	40	4/16	46,89
104520090	2"	50	2/8	72,64
104525090	2"1/2	61	1/6	157,80
104530090	3"	74	1/4	221,75
104540090	4"	95	1/2	365,75



## IVR DZR

50 bar

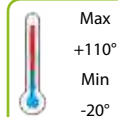

UNI ISO 228-1

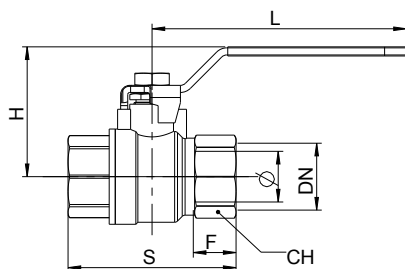

**IVR 20**

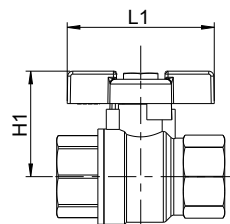

**IVR 20/A**

### DIMENSIONI / DIMENSIONS

DN	Ø	S	L	L1	H	H1	F	CH
3/8"	10	45	80	50	40	33	12	21
1/2"	15	55	90	61	52	39	13,5	25
3/4"	20	61	90	61	55	43	14,5	31
1"	25	72	125	72	64	52	16	38
1"1/4	32	81	125		69	57	17	47
1"1/2	40	94	140		78		18	54
2"	50	112	140		85		22	66

## IVR 20



Valvola a sfera a passaggio totale in DZR - attacchi F/F  
DZR brass full bore ball valve - threaded ends F/F  
Kugelhahn mit vollem Durchgang in DZR - IG/IG  
Vanne à boisseau sphérique à passage intégral in DZR - fixations F/F  
Полнопроходной шаровой кран из латуни DZR - соединения В/В

Cod./Code	Mis./Size	Ø	□/田	€
102003010	3/8"	10	10/120	11,36
102005010	1/2"	15	20/80	10,08
102007010	3/4"	20	15/60	13,72
102010010	1"	25	10/40	23,36
102012010	1"1/4	32	6/24	34,43
102015010	1"1/2	40	4/16	50,72
102020010	2"	50	4/16	77,42



## IVR 20/A



Valvola a sfera a passaggio totale in DZR - attacchi F/F  
DZR brass full bore ball valve - threaded ends F/F  
Kugelhahn mit vollem Durchgang in DZR - IG/IG  
Vanne à boisseau sphérique à passage intégral in DZR - fixations F/F  
Полнопроходной шаровой кран из латуни DZR - соединения В/В

Cod./Code	Mis./Size	Ø	□/田	€
102003011	3/8"	10	10/120	11,36
102005011	1/2"	15	20/80	9,96
102007011	3/4"	20	15/60	13,61
102010011	1"	25	10/40	23,08



## IVR 25



Valvola a sfera a passaggio totale in DZR - attacchi tubo rame compressione  
DZR brass full bore ball valve with compression ends for copper pipe  
Kugelhahn mit vollem Durchgang in DZR - Kompression-Anschlüsse für Kupferrohr  
Vanne à boisseau sphérique à passage intégral in DZR - fixations tube cuivre compression  
Полнопроходной шаровой кран из латуни DZR - компрессионные соединения для медной трубы

Cod./Code	DN	Ø	□/田	€
<b>102505010</b>	15	15	20/80	12,91
<b>102507010</b>	22	20	12/48	17,79
<b>102510010</b>	28	25	8/32	28,71
<b>102535357</b>	35	32	4/16	51,04
<b>102542357</b>	42	40	4/16	75,59
<b>102554357</b>	54	50	2/8	121,93



## IVR 25/A





Valvola a sfera a passaggio totale in DZR - attacchi tubo rame compressione  
DZR brass full bore ball valve with compression ends for copper pipe  
Kugelhahn mit vollem Durchgang in DZR - Kompression-Anschlüsse für Kupferrohr  
Vanne à boisseau sphérique à passage intégral in DZR - fixations tube cuivre compression  
Полнопроходной шаровой кран из латуни DZR - компрессионные соединения для медной трубы

Cod./Code	DN	Ø	□/田	€
<b>102505011</b>	15	15	20/80	12,80
<b>102507011</b>	22	20	20/80	17,65
<b>102510011</b>	28	25	10/40	28,39



### ACCESSORI / RICAMBI - ACCESSORIES / SPARE PARTS

				
3/8"	700101001	703001501	750106001	109702030
1/2"	700111001	703011501	750108001	109705030
3/4"	700111001	703011501	750108001	109705030
1"	700121001	703021501	750110001	109710030
1"1/4	700121001		750110001	109710030
1"1/2	700131001		750114001	109715030
2"	700131001		750114001	109715030

Prezzi indicati nella sezione Accessori/Ricambi a fine capitolo / Prices in section Accessories/Spare Parts at the end of this chapter

## IVR NORDIKA

50 bar

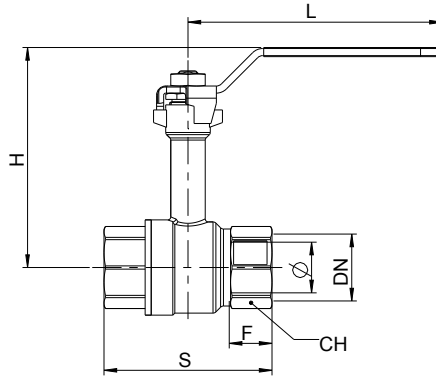
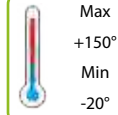

### DIMENSIONI / DIMENSIONS

DN	Ø	S	L	H	F	CH
1/2"	15	63	90	96	17	26
3/4"	20	71	90	100	19,5	31
1"	25	83	125	109	21	38
1"1/4	32	92	125	114	22	48
1"1/2	40	104	140	131	23,5	55
2"	50	124	140	139	28	68

## IVR 200



Valvola a sfera a passaggio totale con asta prolungata - attacchi F/F

Brass full bore ball valve with extension stem - threaded ends F/F

Kugelhahn mit vollem Durchgang und verlängerter Spindel - IG/IG



Vanne à boisseau sphérique à passage intégral avec tige rallonge - fixations F/F

Полнопроходной шаровой кран с удлиненным штоком - соединения В/В

Cod./Code	Mis./Size	Ø	□/田	€
120005007	1/2"	15	10/40	17,95
120007007	3/4"	20	10/40	20,96
120010007	1"	25	6/24	30,16
120012007	1"1/4	32	4/16	42,13
120015007	1"1/2	40	2/8	64,04
120020007	2"	50	2/8	88,95
120025007	2"1/2	60	1/5	238,22



### ACCESSORI / RICAMBI - ACCESSORIES / SPARE PARTS

		
1/2"	700111001	750108001
3/4"	700111001	750108001
1"	700121001	750110001
1"1/4	700121001	750110001
1"1/2	700131001	750114001
2"	700131001	750114001

Prezzi indicati nella sezione Accessori/Ricambi a fine capitolo / Prices in section Accessories/Spare Parts at the end of this chapter

## IVR DRAIN

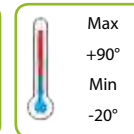
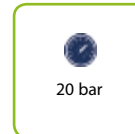

### IVR 68



Valvola a sfera a passaggio totale con tappo e rubinetto di scarico - attacchi F/F - Disponibile anche con maniglia blu o nera  
Full bore ball valve with cap and drain tap - threaded ends F/F - Available with blue or black handle  
Kugelhahn mit vollem Durchgang, Deckel und Ablasshahn - IG/IG - Erhältlich auch mit blauem oder schwarzem Griff  
Vanne à boisseau sphérique à passage intégral avec bouchon et robinet d'évacuation - fixations F/F - Disponible, avec poignée bleu ou noire  
Полнопроходной шаровой клапан с заглушкой и спускным краником - соединения В/В - Доступен также с голубой или чёрной ручкой

Cod./Code	Mis./Size	Ø	□/⊞	€
106805007	1/2"	15	10/60	11,53
106807007	3/4"	20	10/60	14,63
106810007	1"	25	8/32	22,18
106812007	1"1/4	32	8/32	31,78
106815007	1"1/2	40	4/16	42,42
106820007	2"	50	4/16	65,40



### IVR 68/A



Valvola a sfera a passaggio totale con tappo e rubinetto di scarico - attacchi F/F - Disponibile anche con farfalla blu o nera  
Full bore ball valve with cap and drain tap - threaded ends F/F - Available with blue or black butterfly handle  
Kugelhahn mit vollem Durchgang, Deckel und Ablasshahn - IG/IG - Erhältlich auch mit hellblauem oder schwarzem Flügelgriff  
Vanne à boisseau sphérique à passage intégral avec bouchon et robinet d'évacuation - fixations F/F - Disponible aussi avec papillon bleu ou noir  
Полнопроходной шаровой клапан с заглушкой и спускным краником - соединения В/В - Доступен также с голубой или чёрной ручкой-бабочкой

Cod./Code	Mis./Size	Ø	□/⊞	€
106805002	1/2"	15	10/60	11,53
106807002	3/4"	20	10/60	14,63
106810002	1"	25	10/40	22,18



### IVR 69



Valvola a sfera a passaggio totale con tappo e rubinetto scarico - attacchi M/F - Disponibile anche, con maniglia blu o nera  
Full bore ball valve with cap and drain tap - threaded ends M/F - Available with blue or black handle  
Kugelhahn mit vollem Durchgang, Deckel und Ablasshahn - AG/IG - Erhältlich auch mit blauem oder schwarzem Griff  
Vanne à boisseau sphérique à passage intégral avec bouchon et robinet d'évacuation - fixations M/F - Disponible, avec poignée bleu ou noire  
Полнопроходной шаровой кран с заглушкой и спускным краником - соединения Н/В - Доступен также с голубой или чёрной ручкой

Cod./Code	Mis./Size	Ø	□/⊞	€
106905007	1/2"	15	10/60	12,11
106907007	3/4"	20	10/40	15,06
106910007	1"	25	8/32	22,94



### IVR 69/A



Valvola a sfera a passaggio totale con tappo e rubinetto scarico - attacchi M/F - Disponibile anche con farfalla blu o nera  
Full bore ball valve with cap and drain tap - threaded ends M/F - Available with blue or black butterfly handle  
Kugelhahn mit vollem Durchgang, Deckel und Ablasshahn - AG/IG - Erhältlich auch mit blauem oder schwarzem Flügelgriff  
Vanne à boisseau sphérique à passage intégral avec bouchon et robinet d'évacuation - fixations M/F - Disponible aussi, avec papillon bleu ou noir  
Полнопроходной шаровой кран с заглушкой и спускным краником - соединения Н/В - Доступен также с голубой или чёрной ручкой-бабочкой

Cod./Code	Mis./Size	Ø	□/⊞	€
106905008	1/2"	15	10/60	12,11
106907008	3/4"	20	10/60	15,06
106910008	1"	25	8/32	22,94





## IVR VALVOLA CON FILTRO IVR VALVE WITH STRAINER

### IVR 992



Valvola a sfera filettata FF con filtro ad Y incorporato. Leva a farfalla rossa

Ball valve FF with built-in Y strainer. Red butterfly handle

Kugelhahn I/I integriert mit Schmutzfänger. Roter Flügelgriff

Vanne à boisseau sphérique avec filtre Y intégré. Poignée papillon rouge

Кран шаровой со встроенным Y-образным фильтром, резьбовые соединения В/В. Красная ручка-бабочка.

Cod./Code	Mis./Size	□/田	€
199205001	1/2"	15/60	16,09
199207001	3/4"	15/60	23,36
199210001	1"	10/40	36,59



## IVR RIDUTTORE DI MANOVRA IVR VALVE WITH GEAR HANDLE

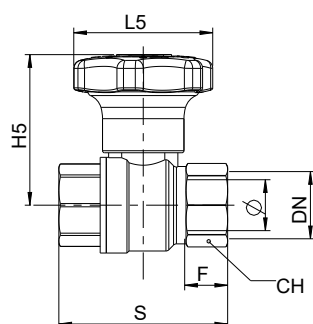

DIMENSIONI / DIMENSIONS

DN	Ø	S	L5	H5	F	CH
3/8"	10	45	70	59	12	21
1/2"	15	63	70	65	17	26
3/4"	20	71	70	68	19,5	31
1"	25	83	70	76	21	38
1"1/4	32	92	70	81	22	48
1"1/2	40	104	112	105	23,5	55
2"	50	124	112	112	28	68
2"1/2	60	140	112	162	28	85

### IVR 137



Valvola a sfera a passaggio totale con riduttore di manovra - attacchi F/F

Full bore ball valve with 360° handle - threaded ends F/F - 7 Threads

Kugelhahn mit vollem Durchgang und Softgriff - IG/IG

Vanne à boisseau sphérique à passage intégral avec réducteur de manoeuvre - fixations F/F

Полнопроходной шаровой кран с ручкой-редуктором - соединения В/В

Cod./Code	Mis./Size	Ø	□/田	€
113702001	1/4"	10	12/48	13,74
113703001	3/8"	10	12/48	14,63
113705001	1/2"	15	9/36	16,71
113707001	3/4"	20	8/32	20,28
113710001	1"	25	8/32	28,70
113712001	1"1/4	32	6/24	38,87
113715001	1"1/2	40	2/8	60,16
113720001	2"	50	2/8	87,33
113725001	2"1/2	61	1/5	190,53



**IVR TRE VIE**  
**IVR 3 WAYS**

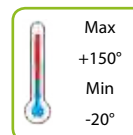
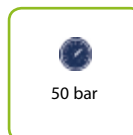

**IVR 70**



Valvola a sfera a tre vie a passaggio ridotto sfera forata a "L" - attacchi F/F/F - Disponibile anche con maniglia nera

3-way valve with reduced bore and perforated ball type L - threaded ends F/F/F - Available with black handle  
 3-Wege-Kugelhahn mit reduziertem Durchgang, Kugel mit L-Bohrung - IG/IG/IG - Erhältlich auch mit schwarzem Griff

Vanne à boisseau sphérique à trois voies à passage réduit sphère percée en "L" - fixations F/F/F - Disponible avec poignée noire

Трехходовой шаровой кран с редуцированным проходом, шар с L-образным проходом - соединения В/В/В - Доступен также с чёрной ручкой

Cod./Code	Mis./Size	Ø	□/田	€
107002003	1/4"	10	5/30	31,05
107003003	3/8"	10	5/30	30,11
107005003	1/2"	12	3/18	38,81
107007003	3/4"	15	2/12	47,67
107010003	1"	20	2/12	74,32
107012003	1"1/4	25	2/8	94,66
107015003	1"1/2	32	1/5	157,81
107020003	2"	40	1/5	237,08



**IVR 71**



Valvola a sfera a tre vie a passaggio ridotto sfera forata a T - attacchi F/F/F - Disponibile anche con maniglia nera

3-way valve with reduced bore and perforated ball type T - threaded ends F/F/F - Available with black handle  
 3-Wege-Kugelhahn mit reduziertem Durchgang, Kugel mit T-Bohrung - IG/IG/IG - Erhältlich auch mit schwarzem Griff

Vanne à boisseau sphérique à trois voies à passage réduit sphère percée en T - fixations F/F/F - Disponible avec poignée noire

Трехходовой шаровой кран с редуцированным проходом, шар с T-образным проходом - соединения В/В/В - Доступен также с чёрной ручкой

Cod./Code	Mis./Size	Ø	□/田	€
107102003	1/4"	10	5/30	31,05
107103003	3/8"	10	5/30	30,11
107105003	1/2"	12	3/18	38,81
107107003	3/4"	15	2/12	47,67
107110003	1"	20	2/12	74,32
107112003	1"1/4	25	2/8	94,66
107115003	1"1/2	32	1/5	157,81
107120003	2"	40	1/5	230,27



## IVR 72



Valvola a sfera a tre vie deviatrice a passaggio ridotto sfera forata a T - attacchi F/F/F

3-way diverter ball valve with reduced bore - type T - F/F/F

3-Wege Ableitventil mit reduziertem Durchgang mit T-Bohrung - IG/IG/IG

Vanne déviatrice à boisseau sphérique à 3 voies avec passage réduit, percée en T - F/F/F

Трехходовой распределительный кран с редуцированным проходом, шар с T-образным проходом, соединение В/В/В

Cod./Code	Mis./Size	Ø	□/田	€
107202001	1/4"	10	10/60	33,22
107203001	3/8"	10	10/60	33,22
107205001	1/2"	12	8/48	33,22
107207001	3/4"	15	6/36	38,46
107210001	1"	20	4/16	52,40
107212001	1"1/4	25	4/16	88,85
107215001	1"1/2	32	4/16	135,03
107220001	2"	40	2/8	192,06



## IVR 73



Valvola a sfera a tre vie deviatrice a passaggio ridotto sfera forata a L - attacchi F/F/F

3-way diverter ball valve with reduced bore - type L - F/F/F

3-Wege Ableitventil mit reduziertem Durchgang mit L-Bohrung - IG/IG/IG

Vanne déviatrice à boisseau sphérique à 3 voies avec passage réduit, percée en L - F/F/F

Трехходовой распределительный кран с редуцированным проходом, сфера с "L" образным отверстием, соединение В/В/В.

Cod./Code	Mis./Size	Ø	□/田	€
107302001	1/4"	10	10/60	33,22
107303001	3/8"	10	10/60	33,22
107305001	1/2"	12	8/48	33,22
107307001	3/4"	15	6/36	38,46
107310001	1"	20	4/16	52,40
107312001	1"1/4	25	4/16	88,85
107315001	1"1/2	32	4/16	135,03
107320001	2"	40	2/8	192,06



## IVR IDRETTO

### IVR 962



Rubinetto a sfera attacco idrante con portagomma, farfalla rossa  
Ball valve with hydrant and pipe connection, red butterfly handle  
Wasserkugelhahn mit Schlauch- und Hydrantenanschluss, roter Flügelgriff  
Vanne à boisseau sphérique avec fixation pour bouche d'incendie  
Кран шаровой садовый со штуцером, красная ручка-бабочка

Cod./Code	Mis./Size	Ø	□/田	€
196205001	1/2"	15	20/80	14,86
196207001	3/4"	20	14/70	19,41



### IVR 966



Rubinetto a sfera con portagomma, leva in acciaio rossa  
Bibcock with hose connection and red steel lever handle  
"Garten-Wasserhahn" mit Schlauchanschluss und rotem Hebelgriff aus Stahl  
Robinet de puisage simple avec poignée plate rouge en acier  
Поливочный кран с насадкой для шланга, красная ручка из нержавеющей стали

Cod./Code	Mis./Size	Ø	□/田	€
196603001	3/8"	10	25/100	7,84
196605001	1/2"	15	25/100	8,27
196607001	3/4"	20	16/64	11,26
196610001	1"	25	8/48	20,00



### IVR 966/A



Rubinetto a sfera con portagomma, farfalla rossa  
Bibcock with hose connection and red butterfly handle  
"Garten-Wasserhahn" mit Schlauchanschluss und rotem Flügelgriff  
Robinet de puisage simple avec poignée papillon rouge  
Поливочный кран с насадкой для шланга, красная ручка " бабочка"

Cod./Code	Mis./Size	Ø	□/田	€
196603002	3/8"	10	25/100	7,84
196605002	1/2"	15	25/100	8,27
196607002	3/4"	20	16/64	11,26
196610002	1"	25	8/48	20,00



## IVR MIGNON

### IVR 925



Mini valvola mignon - attacchi F/F  
Mini-valve mignon - threaded ends F/F  
Kugelhahn Mignon - IG/IG  
Mini vanne mignon - fixations F/F  
Мини шаровой кран "миньон" - соединения В/В

Cod./Code	Mis./Size	Ø	□/田	€
192502001	1/4"	8	60/300	5,43
192503001	3/8"	8	60/300	4,95
192505001	1/2"	10	50/250	5,47



### IVR 926



Mini valvola mignon - attacchi M/F  
Mini-valve mignon - threaded ends M/F  
Kugelhahn Mignon - AG/IG  
Mini vanne mignon - fixations M/F  
Мини шаровой кран "миньон" - соединения Н/В

Cod./Code	Mis./Size	Ø	□/田	€
192602001	1/4"	8	60/300	4,44
192603001	3/8"	8	60/300	4,23
192605001	1/2"	10	50/250	5,26



### IVR 927



Mini valvola mignon - attacchi F/F  
Mini-valve mignon - threaded ends F/F  
Kugelhahn Mignon - IG/IG  
Mini vanne mignon - fixations F/F  
Мини шаровой кран "миньон" - соединения В/В

Cod./Code	Mis./Size	Ø	□/田	€
192701001	1/8"	6	60/300	5,10
192702001	1/4"	8	60/300	4,83
192703001	3/8"	8	60/300	4,44
192705001	1/2"	10	50/250	5,78
112707001	3/4"	14	15/180	11,09



### IVR 928



Mini valvola mignon - attacchi M/F  
Mini-valve mignon - threaded ends M/F  
Kugelhahn Mignon - AG/IG  
Mini vanne mignon - fixations M/F  
Мини шаровой кран "миньон" - соединения Н/В

Cod./Code	Mis./Size	Ø	□/田	€
192801001	1/8"	6	60/300	4,61
192802001	1/4"	8	60/300	4,21
192803001	3/8"	8	60/300	4,04
192805001	1/2"	10	50/250	6,00
112807001	3/4"	14	15/120	11,09



### IVR 129



Mini valvola mignon - attacchi M/M  
Mini-valve mignon - threaded ends M/M  
Kugelhahn Mignon - AG/AG  
Mini vanne mignon - fixations M/M  
Мини шаровой кран "миньон" - соединения Н/Н

Cod./Code	Mis./Size	Ø	□/田	€
112901001	1/8"	6	30/240	9,24
112902001	1/4"	8	30/240	6,85
112903001	3/8"	8	30/240	6,75
112905001	1/2"	10	25/200	7,52



## IVR RUBINETTI IVR SANITARY TAPS

### IVR 136/A



Rubinetto per lavatrice con rosone - attacchi M/M  
Washing machine valve with wallplate - threaded ends M/M  
Wasserhahn für Waschmaschine mit Rosette - AG/AG  
Robinet machine à laver avec rosace - fixations M/M  
Кран для стиральной машины с круглой насадкой - соединения Н/Н

Cod./Code	Mis./Size	Ø	□/田	€
113605002	1/2" x 1/2"	9	25/100	6,25
113607002	1/2" x 3/4"	9	25/100	6,56



### IVR 297



Rubinetto sottolavabo con rosone, tipo corto - attacchi M/M  
Angle ball valve with wallplate, compact type - threaded ends M/M  
Eckregulierventil mit Rosette, kurze Ausführung - AG/AG  
Robinet sous lavabo avec rosace, type court - fixations M/M  
Кран укороченного типа с круглой насадкой под умывальник - соединения Н/Н

Cod./Code	Mis./Size	L (mm)	□/田	€
129703052	3/8" x 1/2"	83	10/120	4,55
129705052	1/2" x 1/2"	83	10/120	4,61



### IVR 298



Rubinetto a sfera sottolavabo con filtro e snodo, provvisto di filtro inox e rosone - finitura cromata lucida  
Under-sink ball valve with filter and ball joint, equipped with filter in stainless steel and wallplate - chrome-plated  
Unterspülekugelhahn mit Schmutzfänger und Verbindung, ausgestattet mit Schmutzfänger aus rostfreiem Stahl und Rosette  
Robinet à boisseau sphérique sous lavabo avec filtre et joint, pourvu de filtre en acier inox et rosette - chromé  
Шаровой кран под умывальник с фильтром и шарниром, оснащен фильтром из нержавеющей стали и круглой насадкой - полированная хромированная отделка

Cod./Code	Mis./Size	□/田	€
129801001	1/2"	20/80	9,07





## IVR INCASSO IVR BUILT-IN VALVES

### IVR 130



Valvola a sfera per incasso a passaggio totale con leva - attacchi F/F  
Full bore ball valve with handle and wallplate for in-wall installations. Threaded ends F/F  
Unterputzkugelhahn mit vollem Durchgang - Handhebel - IG/IG  
Vanne à boisseau sphérique avec poignée et rosette pour installation dans le mur. Fixations F/F  
Полнопроходной шаровой кран с ручкой-флажком, встраиваемый в стену - соединения В/В

Cod./Code	Mis./Size	Ø	□/田	€
113005001	1/2"	15	8/32	22,03
113007001	3/4"	20	6/24	30,87
113010001	1"	25	5/20	43,02



### IVR 134



Valvola a sfera per incasso a passaggio totale con manopola - attacchi F/F  
Full bore ball valve with handle and wallplate for in-wall installations. Threaded ends F/F  
Unterputzkugelhahn mit vollem Durchgang - Drehknopf - IG/IG  
Vanne à boisseau sphérique avec poignée et rosette pour installation dans le mur. Fixations F/F  
Полнопроходной шаровой кран с поворотной ручкой, встраиваемый в стену - соединения В/В

Cod./Code	Mis./Size	Ø	□/田	€
113405001	1/2"	15	6/24	25,75
113407001	3/4"	20	5/20	34,59
113410001	1"	25	4/16	46,68



### IVR 135



Valvola a sfera per incasso a passaggio totale con cappuccio - attacchi F/F  
Full bore ball valve with cap for in-wall installations - Threaded ends F/F  
Unterputzkugelhahn mit vollem Durchgang - Kappe - IG/IG  
Vanne a boisseau sphérique avec capuchon pour installation dans le mur - Fixations F/F  
Полнопроходной шаровой кран с конусным колпачком, встраиваемый в стену - соединения В/В

Cod./Code	Mis./Size	Ø	□/田	€
113505001	1/2"	15	10/40	23,01
113507001	3/4"	20	5/20	31,83
113510001	1"	25	5/20	43,99



## IVR RITEGNO E FILTRI IVR CHECK VALVES AND Y STRAINER

### IVR 993 TG



Valvola di ritegno a clapet con tenuta gomma  
Swing check valve with rubber seat  
Rückschlagventil mit Klappe mit Gummidichtung  
Vanne à clapet avec tenue en gomme  
Обратный клапан clapet с резиновым уплотнением

Cod./Code	Mis./Size	□/⊞	€
199305100	1/2"	18/144	7,40
199307100	3/4"	10/120	10,43
199310100	1"	8/72	14,98
199312100	1"1/4	6/36	24,05
199315100	1"1/2	4/24	36,33
199320100	2"	3/18	53,37
199325100	2"1/2	1/12	79,89
199330100	3"	1/8	127,26
199340100	4"	1/4	222,87



### IVR 993 TM



Valvola di ritegno a clapet con tenuta metallica  
Swing check valve with metal seat  
Rückschlagventil mit Klappe mit Metaldichtung  
Vanne à clapet avec tenue en métal  
Обратный клапан clapet с металлическим уплотнением

Cod./Code	Mis./Size	□/⊞	€
199305001	1/2"	18/144	6,77
199307001	3/4"	10/120	10,43
199310001	1"	8/72	14,98
199312001	1"1/4	6/36	24,05
199315001	1"1/2	4/24	36,33
199320001	2"	3/18	53,37
199325001	2"1/2	1/12	79,89
199330001	3"	1/8	127,26
199340001	4"	1/4	222,87



### IVR 994



Valvola di fondo  
Foot valve  
Fussventil  
Crépine vertical  
Донный клапан

Cod./Code	Mis./Size	□/⊞	€
199405001	1/2"	15/180	6,77
199407001	3/4"	18/108	8,82
199410001	1"	18/108	10,76
199412001	1"1/4	8/48	17,85
199415001	1"1/2	4/24	24,05
199420001	2"	3/18	37,07
199425001	2"1/2	1/16	51,38
199430001	3"	1/12	85,49
199440001	4"	1/5	154,68



## IVR 90



Valvola di fondo tubolare  
Cylindrical foot valve  
Zylinderfussventil  
Crépine vertical cylindrique  
Трубчатый донный клапан

Cod./Code	Mis./Size	□/田	€
109007001	3/4"	40	14,83
109010001	1"	20	18,69
109012001	1"1/4	20	27,50
109015001	1"1/2	10	33,07
109020001	2"	8	47,07
109025001	2"1/2	1/4	89,50
109030001	3"	1	135,86
109040001	4"	1	182,77

## IVR 98



Filtro inox con raccordo in ottone  
Stainless steel mesh filter with brass connection  
Nirostahlfiter mit Messing-Gewinde  
Filtre inox avec raccord en laiton  
Фильтр из нержавеющей стали с латунным соединением

Cod./Code	Mis./Size	□/田	€
109803001	3/8"	50/300	4,32
109805001	1/2"	35/210	4,47
109807001	3/4"	20/120	5,19
109810001	1"	25/100	6,06
109812001	1"1/4	20/120	12,47
109815001	1"1/2	10/60	14,14
109820001	2"	6/36	21,60
109825001	2"1/2	1/20	35,98
109830001	3"	1/10	41,51
109840001	4"	1/6	71,09



## IVR 995 L



Filtro inox con raccordo in nylon  
Stainless steel mesh filter with nylon connection  
Nirostahlfiter mit Nylon-Gewinde  
Crépine seule  
Фильтр из нержавеющей стали с соединением из нейлона

Cod./Code	Mis./Size	□/田	€
199505001	1/2"	18/324	0,94
199507001	3/4"	20/240	1,19
199510001	1"	12/144	1,44
199512001	1"1/4	15/90	1,87
199515001	1"1/2	8/48	2,19
199520001	2"	3/18	2,81
199525001	2"1/2	1/24	5,00
199530001	3"	1/18	5,94
199540001	4"	1/4	8,44



## IVR 999 H



Valvola di ritegno tipo pesante con otturatore in acciaio inox  
Check valve heavy type with inox shutter  
Rückschlagventil, schwere Ausführung, mit Edelstahlklappe  
Clapet de non retour avec obturateur inox  
Обратный клапан с затвором из нержавеющей стали - усиленная версия

Cod./Code	Mis./Size	□/田	€
199903100	3/8"	20/120	7,43
199905100	1/2"	20/120	8,11
199907100	3/4"	12/96	11,61
199910100	1"	15/60	17,85
199912100	1"1/4	8/40	27,35
199915100	1"1/2	6/30	37,41
199920100	2"	3/18	55,66
199925100	2"1/2	1/6	120,12
199930100	3"	1/4	183,60
199940100	4"	1/3	275,36



## IVR 999 L



Valvola di ritegno con otturatore in nylon  
Check valve with nylon shutter  
Rückschlagventil, schwere Ausführung, mit Edelstahlklappe  
Clapet de non retour avec obturateur en nylon  
Обратный клапан с затвором из нейлона

Cod./Code	Mis./Size	□/田	€
199903001	3/8"	20/240	4,44
199905001	1/2"	20/120	5,02
199907001	3/4"	15/150	7,00
199910001	1"	12/96	10,43
199912001	1"1/4	6/72	15,28
199915001	1"1/2	8/48	21,56
199920001	2"	3/18	30,45
199925001	2"1/2	1/16	61,09
199930001	3"	1/12	81,78
199940001	4"	1/4	143,08



## IVR 923



Valvola di ritegno con filtro inox incorporato  
Check valve with built-in mesh  
Rückschlagventil mit eingebautem Edelstahlfilter  
Vanne de retenue avec filtre inox intégré  
Обратный клапан с сетчатым фильтром из нержавеющей стали

Cod./Code	Mis./Size	□/田	€
192305001	1/2"	20/120	3,72
192307001	3/4"	18/108	5,25
192310001	1"	15/90	6,88
192312001	1"1/4	3/36	9,48
192315001	1"1/2	3/36	14,32
192320001	2"	3/12	21,55
192325001	2"1/2	1/12	42,78
192330001	3"	1/8	55,70
192340001	4"	1/5	81,44



## IVR 924



Raccoglitore di impurità a Y, filtro in acciaio inox AISI 304 - attacchi F/F

Y strainer with mesh in inox AISI 304 - threaded ends F/F

Y-förmigem Schmutzfänger aus Messing mit Filter aus rostfreiem Edelstahl AISI 304 - IG/IG

Raccord filtre à tamis incliné en Y avec filtre en inox AISI 304 - fixations F/F

Латунный фильтр "Y" образный из нержавеющей стали AISI 304 - соединения B/B

Cod./Code	Mis./Size	□/田	€
192402001	1/4"	5/200	4,04
192403001	3/8"	40/240	3,47
192405001	1/2"	20/180	5,94
192407001	3/4"	20/120	9,04
192410001	1"	15/90	12,97
192412001	1"1/4	6/36	25,57
192415001	1"1/2	2/24	31,07
192420001	2"	2/12	54,31
192425001	2"1/2	1/10	117,84
192430001	3"	1/8	140,98
192440001	4"	1/4	275,20



## IVR 924 S

**NEW**



Raccoglitore di impurità a Y con rubinetto di scarico, filtro in acciaio inox AISI 304 - attacchi F/F

Y Pattern strainer with drainage valve, filter in stainless steel AISI 304 - F/F

Y-förmiger Verunreinigungssammler mit Ablasshahn, Edelstahlfilter AISI 304 - Stecker/Stecker-Anschlüsse

Collecteur d'impuretés en Y avec robinet de décharge, filtre en acier inox AISI 304 - raccords F/F

Y-образный фильтр со сливным краником - фильтр из нержавеющей стали AISI 304 - соединения F/F

Cod./Code	Mis./Size	□/田	€
192405020	1/2"	20/120	11,78
192407020	3/4"	15/90	15,01
192410020	1"	9/54	20,10
192412020	1"1/4	2/24	32,81
192415020	1"1/2	2/24	39,99
192420020	2"	1/6	57,01



## IVR SARACINESCHE IVR GATE VALVES

### IVR 140



Saracinesca PN 20 - attacchi F/F  
Gate valve PN 20 - threaded ends F/F  
Muffen-Absperrschieber PN 20 - IG/IG  
Vanne à passage direct PN 20 - fixations F/F  
Клиновья задвижка PN 20 - Соединения В/В

Cod./Code	Mis./Size	□/田	€
114003001	3/8"	20/120	10,37
114005001	1/2"	20/120	12,43
114007001	3/4"	10/60	17,25
114010001	1"	10/60	23,96
114012001	1"1/4	10/60	34,62
114015001	1"1/2	5/30	45,76
114020001	2"	5/25	66,83
114025001	2"1/2	1/10	101,20
114030001	3"	1/5	130,63
114040001	4"	1/4	212,91



### IVR 605



Saracinesca PN 16 - attacchi F/F  
Gate valve PN 16 - threaded ends F/F  
Muffen-Absperrschieber PN 16 - IG/IG  
Vanne à passage direct PN 16 - fixations F/F  
Клиновья задвижка PN 16 - Соединения В/В

Cod./Code	Mis./Size	□/田	€
160505010	1/2"	20/80	8,96
160507010	3/4"	20/80	11,30
160510010	1"	12/48	17,01
160512010	1"1/4	12/48	21,14
160515010	1"1/2	8/32	31,48
160520010	2"	2/8	44,85
160525001	2"1/2	1/8	66,29
160530001	3"	1/10	86,89
160540001	4"	1/4	163,42
160550010	5"	1/2	374,06
160560010	6"	1/2	491,73





## IVR 600



Saracinesca PN 10 - attacchi F/F  
Gate valve PN 10 - threaded ends F/F  
Muffen-Absperrschieber PN 10 - IG/IG  
Vanne à passage direct PN 10 - fixations F/F  
Клиновaя задвижка PN 10 - Соединения В/В

Cod./Code	Mis./Size	□/田	€
160005333	1/2"	20/80	8,58
160007333	3/4"	20/80	10,80
160010333	1"	15/60	11,97
160012333	1"1/4	10/40	19,71
160015333	1"1/2	12/48	22,91
160020333	2"	3/12	38,72



## IVR 620



Saracinesca BS 5154 - Attacchi tubo rame compressione - (a richiesta: attacchi per tubo rame irlandese)  
Gate valve BS 5154 with compression ends for copper pipe - (Irish pipe connections available on request)  
Muffen-Absperrschieber BS 5154 - Kompressionsanschluss für Kupferrohr - (auf Anfrage: Anschlüsse für irländisches Kupferrohr)  
Vanne à passage direct BS 5154 - Fixations tube cuivre compression - (sur demande: fixations pour tube en cuivre irlandais)  
Клиновaя задвижка BS 5154 - с компрессионными соединениями для медной трубы - (под заказ: соединения для ирландской медной трубы)

Cod./Code	DN	□/田	€
162015001	15	100	10,33
162022001	22	50	13,42
162028001	28	40	21,79



## IVR RIDUTTORE DI PRESSIONE IVR PRESSURE REDUCING

### IVR 302



Riduttore di pressione in ottone nichelato - attacchi F/F  
Pressure reducing valve nickel-plated. F/F threaded ends  
Druckminderer aus vernickeltem Messing - IG/IG  
Réducteur de pression F/F en laiton nickelé - Taraudage F/F  
Редуктор давления из никелированной латуни. Соединения В/В

Cod./Code	Mis./Size	□/田	€
130205100	1/2"	1/50	21,96



### IVR 304



Riduttore di pressione in ottone nichelato - attacchi F/F - con attacco manometro 1/4"  
Pressure reducing valve nickel-plated - threaded ends F/F - with pressure gauge connection 1/4"  
Druckminderer aus vernickeltem Messing - IG/IG - mit Manometeranschluss 1/4"  
Réducteur de pression en laiton nickelé - fixations F/F - avec fixation manomètre 1/4"  
Редуктор давления из никелированной латуни - соединения В/В - с соединением для манометра 1/4"

Cod./Code	Mis./Size	□/田	€
130403001	3/8"	1/50	22,53
130405001	1/2"	1/50	23,42
130407001	3/4"	1/50	23,96



### IVR 305



Riduttore di pressione in ottone nichelato - attacchi F/F - con attacco manometro 1/4"  
Pressure reducing valve nickel-plated - threaded ends F/F - with pressure gauge connection 1/4"  
Druckminderer aus vernickeltem Messing - IG/IG - mit Manometeranschluss 1/4"  
Réducteur de pression en laiton nickelé - fixations F/F - avec fixation manomètre 1/4"  
Редуктор давления из никелированной латуни - соединения В/В - с соединением для манометра 1/4"

Cod./Code	Mis./Size	□/田	€
130505001	1/2"	1/15	42,30
130507001	3/4"	1/15	45,35
130510001	1"	1/10	72,38
130512001	1"1/4	1/6	122,06
130515001	1"1/2	1/6	127,86
130520001	2"	1/4	202,63
130525001	2"1/2	1/3	328,07
130530001	3"	1/3	393,20



## IVR 303



Riduttore di pressione con sede in acciaio inox - bocchettoni F/F - con attacco manometro 1/4"  
Pressure reducing valve with stainless steel seat - tail piece F/F - with pressure gauge connection 1/4"  
Druckminderer mit Sitz aus Edelstahl - IG/IG - mit Manometeranschluss 1/4"  
Réducteur de pression avec siège en acier inox - fixations F/F - avec fixation manomètre 1/4"  
Редуктор давления с седлом из нержавеющей стали, соединения с накидной гайкой В/В - с соединением для манометра 1/4"

Cod./Code	Mis./Size	□/田	€
130305001	1/2"	1/15	56,20
130307001	3/4"	1/10	86,60
130310001	1"	1/10	97,70
130312001	1"1/4	1/6	183,81
130315001	1"1/2	1/6	185,27
130320001	2"	1/4	282,71



## IVR 300



Riduttore di pressione con sede in acciaio inox - bocchettoni M/M - con attacco manometro 1/4"  
Pressure reducing valve with stainless steel seat - tail piece M/M - with pressure gauge connection 1/4"  
Druckminderer mit Sitz aus Edelstahl - AG/AG - mit Manometeranschluss 1/4"  
Réducteur de pression avec siège en acier inox - fixations M/M - avec fixation manomètre 1/4"  
Редуктор давления с седлом из нержавеющей стали - соединения с накидной гайкой Н/Н - с соединением для манометра 1/4"

Cod./Code	Mis./Size	□/田	€
130005001	1/2"	1/18	50,41
130007001	3/4"	1/15	57,21
130010001	1"	1/10	91,95
130012001	1"1/4	1/6	154,39
130015001	1"1/2	1/6	168,38
130020001	2"	1/4	273,07



## IVR 306



Ammortizzatore del colpo d'ariete  
Water hammer absorber  
Wasserrückschlagdämpfer  
Amortisseur du coup de bélier  
Амортизатор гидравлического удара

Cod./Code	Mod./Model	Mis./Size	□/田	€
130605001	nichelata - nickel	1/2"	1/40	34,60
130605002	Gialla - Yellow	1/2"	1/40	33,05



## FILTRO AUTOPULENTE SELF-CLEANING FILTER

### IVR 398



Filtro autopulente F/F  
Self-cleaning filter F/F  
Selbstreinigender Filter IG/IG  
Filtre autonettoyant F/F  
Самоочищающийся фильтр В/В

Cod./Code	Mis./Size	□/田	€
139805001	1/2"	1/8	93,50
139807001	3/4"	1/8	93,50
139810001	1"	1/6	122,54
139812001	1"1/4	1/6	122,54
139815001	1"1/2	1/3	192,91
139820001	2"	1/3	192,91



### IVR 399



Filtro autopulente F/F con manometri  
Self-cleaning filter F/F with pressure gauges  
Selbstreinigender Filter IG/IG mit Manometern  
Filtre autonettoyant F/F avec manomètres  
Самоочищающийся фильтр В/В с манометрами

Cod./Code	Mis./Size	□/田	€
139905001	1/2"	1/8	115,16
139907001	3/4"	1/8	115,16
139910001	1"	1/6	144,19
139912001	1"1/4	1/6	144,19
139915001	1"1/2	1/3	214,57
139920001	2"	1/3	214,57



## RACCORDI A PRESSARE EVERFIT PRESS FITTINGS EVERFIT

### IVR 394

NEW



Raccordo diritto per tubo multistrato  
Straight fitting for multilayer pipe  
Anschlussstück mit gerader Verschraubung für mehrschichtiges Rohr  
Raccord droit pour tube multicouche  
Прямой фитинг для многослойной трубы

Cod./Code	Mis./Size	L (mm)	□/田	€
139400161	16 x 2	57	30/240	4,27
139400201	20 x 2	57	25/200	5,49
139400261	26 x 3	69	15/120	8,27
139400321	32 x 3	69	5/80	10,61



### IVR 397

NEW



Raccordo ridotto diritto maschio per tubo multistrato  
Straight male size reduction fitting for multilayer pipe  
Anschlussstück mit gerader Verschraubung - AG für mehrschichtiges Rohr  
Raccord réduit droit, mâle, pour tube multicouche  
Прямой фитинг редуцированный с наружной резьбой для многослойной трубы

Cod./Code	Mis./Size	L (mm)	□/田	€
139720161	20x2 - 16x2	57	25/200	4,80
139726201	26x2 - 20x2	63	15/120	7,40
139732261	32x2 - 26x2	69	10/80	9,64



### IVR 445

NEW



Raccordo diritto maschio per tubo multistrato  
Straight male fitting for multilayer pipe  
Anschlussstück mit gerader Verschraubung - AG für mehrschichtiges Rohr  
Raccord droit mâle pour tube multicouche  
Прямой фитинг с наружной резьбой для многослойной трубы

Cod./Code	Mis./Size	L (mm)	Att./Conn.	□/田	€
144505161	16 x 2	48	R 1/2"	35/280	3,91
144505201	20 x 2	48	R 1/2"	35/280	4,29
144507201	20 x 2	49	R 3/4"	25/200	5,12
144507261	26 x 3	55	R 3/4"	15/120	6,17
144510261	26 x 3	57	R 1"	5/120	8,62
144510321	32 x 3	56	R 1"	12/96	8,63



## IVR 446

NEW



Raccordo diritto femmina per tubo multistrato  
Straight female fitting for multilayer pipe  
Anschlussstück mit gerader Verschraubung - IG für mehrschichtiges Rohr  
Raccord droit femelle pour tube multicouche  
Прямой фитинг с внутренней резьбой для многослойной трубы

Cod./Code	Mis./Size	L (mm)	Att./Conn.	□/田	€
144605161	16 x 2	45	G 1/2"	35/280	3,94
144605201	20 x 2	45	G 1/2"	30/240	4,39
144607201	20 x 2	46	G 3/4"	20/160	5,77
144607261	26 x 3	52	G 3/4"	15/120	6,77
144610321	32 x 3	53	G 1"	10/80	9,23



## IVR 447

NEW



Raccordo a gomito per tubo multistrato  
Elbow fitting for multilayer pipe  
Ellbogen Anschluss für mehrschichtiges Rohr  
Raccord coudé pour tube multicouche  
Угловой фитинг для многослойной трубы

Cod./Code	Mis./Size	L (mm)	H (mm)	□/田	€
144700161	16 x 2	39	39	25/200	5,01
144700201	20 x 2	42	42	18/144	6,42
144700261	26 x 3	51	51	10/80	11,29
144700321	32 x 3	54	54	5/40	16,29



## IVR 448

NEW



Raccordo a gomito maschio per tubo multistrato  
Male elbow fitting for multilayer pipe  
Ellbogen Anschluss - AG für mehrschichtiges Rohr  
Raccord coudé mâle pour tube multicouche  
Угловой фитинг с наружной резьбой для многослойной трубы

Cod./Code	Mis./Size	L (mm)	H (mm)	Att./Conn.	□/田	€
144805161	16 x 2	42	34	R 1/2"	25/200	4,64
144805201	20 x 2	42	36	R 1/2"	20/160	5,49
144807201	20 x 2	45	38	R 3/4"	15/120	6,18
144807261	26 x 3	51	40	R 3/4"	10/80	8,12
144810321	32 x 3	56	46	R 1"	5/60	13,73



## IVR 449

NEW



Raccordo a gomito femmina per tubo multistrato  
Female elbow fitting for multilayer pipe  
Ellbogen Anschluss - IG für mehrschichtiges Rohr  
Raccord coudé femelle pour tube multicouche  
Угловой фитинг с внутренней резьбой для многослойной трубы

Cod./Code	Mis./Size	L (mm)	H (mm)	Att./Conn.	□/田	€
144905161	16 x 2	43	25	G 1/2"	25/200	4,51
144905201	20 x 2	43	25	G 1/2"	20/160	5,11
144907201	20 x 2	46	28	G 3/4"	15/120	6,40
144907261	26 x 3	52	28	G 3/4"	10/80	8,08
144910321	32 x 3	56	32	G 1"	8/56	12,05





## IVR 464

NEW



Raccordo a gomito per tubo multistrato con staffa  
Elbow fitting for multilayer pipe with flange  
Ellbogen Anschluss für mehrschichtiges Rohr mit Bügel  
Raccord coudé pour tube multicouche avec support  
Угловой фитинг для многослойной трубы с кронштейном

Cod./Code	Mis./Size	L (mm)	H (mm)	Att./Conn.	□/⊞	€
146405161	16 x 2	38	42	G 1/2"	14/112	6,17
146405201	20 x 2	42	42	G 1/2"	12/96	6,99



## IVR 466

NEW



Raccordo a gomito per tubo multistrato con staffa tipo lungo  
Elbow fitting for multilayer pipe with flange - long pattern  
Ellbogen Anschluss für mehrschichtiges Rohr mit Bügel - lange Ausführung  
Raccord coudé pour tube multicouche avec support, type long  
Угловой фитинг для многослойной трубы с удлиненным кронштейном

Cod./Code	Mis./Size	L (mm)	H (mm)	Att./Conn.	□/⊞	€
146605161	16 x 2	50	46	G 1/2"	7/112	7,59
146605201	20 x 2	50	46	G 1/2"	6/96	8,15



## IVR 467

NEW



Raccordo a Tee per tubo multistrato  
Tee fitting for multilayer pipe  
T-Anschluss für mehrschichtiges Rohr  
Raccord Té pour tube multicouche  
Тройник для многослойной трубы

Cod./Code	Mis./Size	L (mm)	H (mm)	□/⊞	€
146700161	16 x 2	78	39	15/120	6,67
146700201	20 x 2	84	42	5/100	8,66
146700261	26 x 3	102	51	4/48	15,77
146700321	32 x 3	108	54	4/32	22,36



## IVR 468

NEW



Raccordo a Tee ridotto per tubo multistrato  
Size Reduction Tee fitting for multilayer pipe  
Reduziertes T-Stück für mehrschichtiges Rohr  
Raccord Té réduit pour tube multicouche  
Тройник редуцированный для многослойной трубы

Cod./Code	Mis./Size	L (mm)	H (mm)	□/⊞	€
1468162016	16x2 - 20x2 - 16x2	54	40	15/120	8,16
1468201616	20x2 - 16x2 - 16x2	80	42	15/120	8,44
1468201620	20x2 - 16x2 - 20x2	80	42	5/100	8,64
1468202016	20x2 - 20x2 - 16x2	84	42	10/80	9,28
1468261616	26x2 - 16x2 - 16x2	86	44	5/75	10,74
1468261626	26x2 - 16x2 - 26x2	86	44	4/64	12,84
1468262020	26x2 - 20x2 - 20x2	90	45	4/64	12,09
1468262026	26x2 - 20x2 - 26x2	96	45	4/64	13,38
1468262620	26x2 - 26x2 - 20x2	96	51	4/48	14,35
1468322032	32x2 - 20x2 - 32x2	96	48	5/40	18,98
1468322626	32x2 - 26x2 - 26x2	102	54	5/40	18,91
1468322632	32x2 - 26x2 - 32x2	102	54	5/40	21,34



## IVR 469

NEW



Raccordo a Tee per tubo multistrato  
 Tee fitting for multilayer pipe - Female Connection  
 T-Anschluss für mehrschichtiges Rohr  
 Raccord Té femelle pour tube multicouche  
 Тройник для многослойной трубы

Cod./Code	Mis./Size	L (mm)	H (mm)	Att./Conn.	□/田	€
146905161	16 x 2	86	25	G 1/2"	15/120	6,83
146905201	20 x 2	86	25	G 1/2"	10/80	8,03
146907261	26 x 3	103	28	G 3/4"	4/64	13,19
146910321	32 x 3	111	32	G 1"	4/32	19,29
335814050					1	3.350,00



## IVR 470

NEW



Adattatore sede conica per tubo multistrato  
 Adapter with conical seat for multilayer pipe  
 Adapter mit konischem Sitz für mehrschichtiges Rohr  
 Adaptateur à siège conique pour tube multicouche  
 Переходник конический для многослойной трубы

Cod./Code	Mis./Size	L (mm)	Att./Conn.	□/田	€
147005161	16 x 2	48	G 1/2"	42/336	4,97
147005201	20 x 2	48	G 1/2"	30/240	5,55
147007161	16 x 2	50	G 3/4" EK	24/192	6,43
147007201	20 x 2	54	G 3/4" EK	18/144	7,22



## IVR RACCORDERIA IVR FITTINGS

### IVR 312 P



Raccordo diritto in due pezzi a sede piana con guarnizione  
2-piece union end with gasket  
Anschlussstück mit gerader Verschraubung, zweiteilig, mit Flachsitz und Dichtung  
Raccord droit en deux pièces à siège plat avec joint  
Двухсоставной прямой соединительный фитинг с плоским седлом и уплотнением

Cod./Code	Mis./Size	□/田	€
131205002	1/2" x 3/4"	50/200	2,98
131207002	3/4" x 1"	50/200	3,96
131210002	1" x 1"1/4	20/80	6,41
131212002	1"1/4 x 1"1/2	15/60	8,31
131215002	1"1/2 x 2"	10/40	20,52
131220002	2" x 2"1/2	1/24	41,49



### IVR 312 PN



Raccordo diritto in due pezzi a sede piana con guarnizione, nichelato  
Nickel-plated 2-piece straight union end with flat seat with gasket  
Vernickeltes zweiteiliges Anschlussstück mit gerader Verschraubung und flachem Sitz mit Dichtung  
Raccord droit nickelé en deux pièces à siège plate avec joint  
Никелированный двухсоставной прямой соединительный фитинг с плоским седлом и уплотнением.

Cod./Code	Mis./Size	□/田	€
131205001	1/2" x 3/4"	50/200	3,06
131207001	3/4" x 1"	50/200	4,24
131210001	1" x 1"1/4	20/80	6,59
131212001	1"1/4 x 1"1/2	15/60	8,56
131215001	1"1/2 x 2"	10/40	21,37
131220001	2" x 2"1/2	1/24	43,41



### IVR 310 P



Raccordo diritto in tre pezzi a sede piana con guarnizione  
3 pieces union end with gasket  
Anschlussstück mit gerader Verschraubung, dreiteilig, mit Flachsitz und Dichtung  
Raccord droit en trois pièces à siège plat avec joint  
Трёхсоставной прямой соединительный фитинг с плоским седлом и уплотнением

Cod./Code	Mis./Size	□/田	€
131003001	3/8"	20/120	4,01
131005001	1/2"	20/120	4,52
131007001	3/4"	20/80	6,31
131010001	1"	20/80	10,40
131012001	1"1/4	10/40	13,70
131015001	1"1/2	5/30	31,32
131020001	2"	3/12	56,28



### IVR 310 PN



Raccordo diritto in tre pezzi a sede piana con guarnizione, nichelato  
Nickel-plated 3-piece straight union end with flat seat with gasket  
Vernickeltes dreiteiliges Anschlussstück mit gerader Verschraubung und flachem Sitz mit Dichtung  
Raccord droit nickelé en trois pièces à siège plate avec joint  
Никелированный трёхсоставной прямой соединительный фитинг с плоским седлом и уплотнением

Cod./Code	Mis./Size	□/田	€
131003002	3/8"	20/120	4,24
131005002	1/2"	20/120	4,65
131007002	3/4"	20/80	6,50
131010002	1"	20/80	10,69
131012002	1"1/4	10/40	14,32
131015002	1"1/2	5/30	32,80
131020002	2"	3/12	58,83



## IVR 315 P



Raccordo curvo in tre pezzi a sede piana con guarnizione

Elbor 3 pieces union end with gasket

Anschlussstück mit gebogener Verschraubung, dreiteilig, mit Flachsitz und Dichtung

Raccord courbe en trois pièces à siège plat avec joint

Трёхсоставной угловой соединительный фитинг с плоским седлом и уплотнением

Cod./Code	Mis./Size	□/田	€
131503001	3/8"	25/150	4,87
131505001	1/2"	20/120	6,77
131507001	3/4"	20/80	10,79
131510001	1"	12/48	19,25
131512001	1"1/4	10/40	26,25
131515001	1"1/2	5/20	42,96
131520001	2"	2/8	78,72



## IVR 315 PN



Raccordo curvo in tre pezzi a sede piana con guarnizione, nichelato

Nickel-plated 3-piece straight union end with flat seat with gasket

Vernickeltes dreiteiliges Anschlussstück mit Eckverschraubung und flachem Sitz mit Dichtung

Raccord équerre nickelé en trois pièces à siège plate avec joint

Никелированный трёхсоставной угловой соединительный фитинг с плоским седлом и уплотнением.

Cod./Code	Mis./Size	□/田	€
131503002	3/8"	25/150	5,08
131505002	1/2"	20/120	6,99
131507002	3/4"	20/80	11,23
131510002	1"	12/48	20,31
131512002	1"1/4	10/40	63,49
131515002	1"1/2	5/20	44,65
131520002	2"	2/8	83,37



## IVR 310 C



Raccordo diritto in tre pezzi a sede conica con o-ring

3 pieces union end conical seat with o-ring

Anschlussstück mit gerader Verschraubung, dreiteilig, mit Kegelsitz und O-Ring

Raccord droit en trois pièces à siège conique avec o-ring

Трёхсоставной прямой соединительный фитинг с коническим седлом и уплотняющим O-кольцом

Cod./Code	Mis./Size	□/田	€
131003010	3/8"	20/120	4,01
131005010	1/2"	50/200	4,61
131007010	3/4"	25/100	6,56
131010010	1"	20/80	10,77
131012010	1"1/4	10/40	14,26
131015010	1"1/2	5/30	31,32
131020010	2"	3/12	56,28



## IVR 310 CN



Raccordo diritto in tre pezzi a sede conica con o-ring, nichelato

Nickel-plated 3-piece straight union end with conical seat and O-ring

Vernickeltes dreiteiliges Anschlussstück mit gerader Verschraubung und Kegelsitz mit O-Ring

Raccord droit nickelé en trois pièces à siège conique avec O-Ring

Никелированный трёхсоставной прямой соединительный фитинг с коническим седлом и уплотняющим O-кольцом.

Cod./Code	Mis./Size	□/田	€
131003012	3/8"	20/120	4,24
131005012	1/2"	50/200	4,79
131007012	3/4"	25/100	6,79
131010012	1"	20/80	11,06
131012012	1"1/4	10/40	14,89
131015012	1"1/2	5/30	76,29
131020012	2"	3/12	58,83



## IVR 315 C



Raccordo curvo in tre pezzi a sede conica con o-ring  
Elbow 3 pieces union end conical seat with o-ring  
Anschlussstück mit gebogener Verschraubung, dreiteilig, mit Kegelsitz und O-Ring  
Raccord courbe en trois pièces à siège conique avec o-ring  
Трёхсоставной угловой соединительный фитинг с коническим седлом и уплотняющим O-кольцом

Cod./Code	Mis./Size	□/田	€
131503010	3/8"	25/150	4,87
131505010	1/2"	20/120	6,77
131507010	3/4"	20/80	10,79
131510010	1"	12/48	19,25
131512010	1"1/4	10/40	26,25
131515010	1"1/2	5/20	42,96
131520010	2"	2/8	78,72



## IVR 315 CN



Raccordo curvo in tre pezzi a sede conica con o-ring, nichelato  
Nickel-plated 90-degree 3-piece straight union end with conical seat and O-ring  
Vernickeltes dreiteiliges Anschlussstück mit Eckverschraubung und Kegelsitz mit O-Ring  
Raccord équerre nickelé en trois pièces à siège conique avec o-ring  
Никелированный трёхсоставной угловой соединительный фитинг с коническим седлом и уплотняющим O-кольцом.

Cod./Code	Mis./Size	□/田	€
131503012	3/8"	25/150	5,08
131505012	1/2"	20/120	6,99
131507012	3/4"	20/80	11,23
131510012	1"	12/48	20,31
131512012	1"1/4	10/40	27,29
131515012	1"1/2	5/20	44,65
131520012	2"	2/8	83,37



## IVR 320



Raccordo a cinque vie tipo corto  
Five ways short connection  
5-Wege-Anschlussstück, kurze Ausführung  
Raccord à cinq voies type court  
Укороченный соединительный фитинг на пять выходов

Cod./Code	Mis./Size	□/田	€
132010001	1"	20/80	11,85



## IVR 321



Raccordo a cinque vie tipo lungo  
Five ways long pattern connection  
5-Wege-Anschlussstück, lange Ausführung  
Raccord à cinq voies type long  
Удлиненный соединительный фитинг на пять выходов

Cod./Code	Mis./Size	□/田	€
132110001	1"	20/80	15,14



## IVR 307



Raccordo gomito femmina con flangia nichelato  
Elbow connection F with flange, nickel-plated  
Anschlusskniestück IG mit Flansche, vernickelt  
Raccord coudé F avec bride, nickelé

Угольник, внутреннее соединение с фланцевым креплением, никелированный

Cod./Code	Mis./Size	Att./Conn.	□/⊞	€
130705071	1/2"	3/4" EK	10/120	7,50
130705242	1/2"	24-19	10/120	7,02
130707071	3/4"	3/4"EK	10/60	9,27

## IVR 308



Raccordo a T maschio nichelato  
T-Union, M, nickel-plated  
T-Anschluss, AG, vernickelt  
Raccord en T, M, nickelé

Тройник Т-образный, H соединение, никелированный

Cod./Code	Mis./Size	Att./Conn.	□/⊞	€
130805241	1/2"	24-19	25/100	5,79
130807071	3/4"	3/4"	25/100	6,37
130807242	3/4"	24-19	25/100	5,94

## IVR 357



Raccordo a T femmina nichelato  
T-Union, F, nickel-plated  
T-Anschluss, IG, vernickelt  
Raccord en T, F, nickelé

Тройник Т-образный, В соединение, никелированный

Cod./Code	Mis./Size	Att./Conn.	□/⊞	€
135705071	1/2"	3/4"	20/100	6,19
135705242	1/2"	24-19	20/100	5,09
135707071	3/4"	3/4"	20/100	8,61
135707242	3/4"	24-19	20/100	7,96

## IVR 403



Raccordo diritto maschio nichelato  
Straight connector, M, nickel-plated  
Gerader Anschluss, AG, vernickelt  
Raccord droit, M, nickelé

Ниппель - Наружный - Никелированный

Cod./Code	Mis./Size	Att./Conn.	□/⊞	€
140305071	1/2"	3/4"EK	25/150	3,76
140305241	1/2"	24-19	25/150	4,50
140307071	3/4"	3/4"EK	25/150	4,50
140307241	3/4"	24-19	25/150	3,63

## IVR 420



Raccordo diritto intermedio maschio nichelato  
Straight connector, M, nickel-plated  
Gerader Anschluss, AG, vernickelt  
Raccord droit, M, nickelé

Ниппель прямой, промежуточный, с наружной резьбой, никелированный

Cod./Code	Mis./Size	Att./Conn.	□/⊞	€
142007071	3/4"	3/4"EK	25/150	4,50
142024241	24 - 19	24-19	25/150	3,48



## IVR 426



Raccordo diritto femmina nichelato  
 Straight connection, F, nickel-plated  
 Gerader Anschluss, IG, vernickelt  
 Raccord droit F, nickelé  
 Прямой фитинг, В, никелированный

Cod./Code	Mis./Size	Att./Conn.	□/⊕	€
142605071	1/2"	3/4"EK	20/240	3,70
142605241	1/2"	24-19	20/240	3,30
142607071	3/4"	3/4"EK	20/240	5,01
142607241	3/4"	24-19	20/240	5,48
142624071	24 - 19	3/4"EK	20/240	3,90

## IVR 427



Raccordo gomito maschio nichelato  
 Elbow connection, M, nickel-plated  
 Anschlusskniestück AG, vernickelt  
 Raccord coudé, M, nickelé  
 Угольник, наружное соединение, никелированный

Cod./Code	Mis./Size	Att./Conn.	□/⊕	€
142705071	1/2"	3/4"EK	25/150	4,72
142705241	1/2"	24-19	25/150	4,53
142707071	3/4"	3/4"EK	25/150	5,59
142707241	3/4"	24-19	25/150	5,09



## ACCESSORI LINEA ACQUA ACCESSORIES FOR WATER LINE

### IVR 97



Kit prolunga per isolamento termico con guaina anti rotazione - Per valvole ottone  
Stem extension kit for thermal insulation with no-rotating plastic cover - For brass ball valves  
Verlängerungsgarnitur für Wärmeisolierung mit drehungsbegrenzender Hülle - für Messingskugelhähne  
Kit de rallongement pour isolation thermique avec gaine anti-rotation - Pour vannes en laiton  
Комплект удлиняющий с противовращательной защитой для установки теплоизоляции - для латунных клапанов

Cod./Code	Mod./Model	□/⊞	€
109702030	Mignon M8	40/160	7,62
109705030	1a MIS	20/80	10,01
109710030	2a MIS	15/60	12,04
109715030	3a MIS	10/40	15,79
109720010	4a MIS	6/24	46,10
109725010	5a MIS	4/24	32,63



### IVR 130 P



Prolunga per valvole incasso  
Set of stem for ball valves for in-wall installations  
Verlängerung für verchromte Unterputzventilteile  
Rallonge pour vannes à encastrer  
Набор удлинительных штоков для встраиваемых клапанов

Cod./Code	Mod./Model	Mis./Size	□/⊞	€
109799001	Prolunga / Stem - 130-134-135	1/2" - 3/4" - 1"	50/200	5,41

### IVR 359



Manometro Ø 50 - 63 mm - attacco posteriore per IVR 300 - 303 - 305  
Axial pressure gauge Ø 50 - 63 mm - back connection for IVR 300 - 303 - 305  
Manometer Ø 50 - 63 mm - Anschluss hinten, für IVR 300 - 303 - 305  
Manomètre Ø 50 - 63 mm - fixation arrière pour IVR 300 - 303 - 305  
Манометр с осевым подключением Ø 50 - 63 мм - для IVR 300 - 303 - 305

Cod./Code	Mod./Model	Mis./Size	Ø	□/⊞	€
135902116	scale 0-16 bar	1/4"	50	1/100	11,87
135902206	scale 0-6 bar	1/4"	63	1/80	11,87
135902210	scale 0-10 bar	1/4"	63	1/80	11,87
135902216	scale 0-16 bar	1/4"	63	1/80	11,87



## RICAMBI LINEA ACQUA SPARE PARTS FOR WATER LINE

### IVR 256 BL



Maniglia lucchettabile. Anti-manomissione  
Lockable handle. Tamper proof  
Verriegelbarer Hebelgriff - Betätigungsschutz  
Poignée cadenassable. Anti-violation  
Запираемая ручка с защитой от взлома

Cod./Code	Mod./Model	□/田	€
125603600	MIGNON	10/120	2,55
125605600	1a MIS	10/120	3,12
125610600	2 MIS	10/60	3,95
125615600	3 MIS	10/40	6,80



### IVR 256 RO



Maniglia lucchettabile. Anti-manomissione  
Lockable handle. Tamper proof  
Verriegelbarer Hebelgriff - Betätigungsschutz  
Poignée cadenassable. Anti-violation  
Запираемая ручка с защитой от взлома

Cod./Code	Mod./Model	□/田	€
125603440	MIGNON	10/120	2,55
125605440	1a MIS	10/120	3,12
125610440	2 MIS	10/60	3,95
125615440	3 MIS	10/40	6,80



### IVR FARFALLA ALL. AZZURRA



Maniglia a farfalla blu in alluminio  
Blue butterfly handle in aluminium  
Blauer Flügelgriff aus Aluminium  
Poignée papillon bleue en aluminium  
Голубая ручка "бабочка" из алюминия

Cod./Code	Mod./Model	□/田	€
703005001	Mignon	10/120	0,74
703015001	1a MIS	10/120	0,93
703025001	2a MIS	10/120	1,09

### IVR FARFALLA ALL. NERA



Maniglia a farfalla nera in alluminio  
Black butterfly handle in aluminium  
Schwarzer Flügelgriff aus Aluminium  
Poignée papillon noire en aluminium  
Черная ручка "бабочка" из алюминия

Cod./Code	Mod./Model	□/田	€
703002001	Mignon	10/120	0,74
703012001	1a MIS	10/120	0,93
703022001	2a MIS	10/120	1,09

## IVR FARFALLA ALL. ROSSA



Maniglia a farfalla rossa in alluminio  
Red butterfly handle in aluminium  
Roter Flügelgriff aus Aluminium  
Poignée papillon rouge en aluminium  
Красная ручка "бабочка" из алюминия

Cod./Code	Mod./Model	□/田	€
703001501	Mignon	50/750	0,68
703011501	1a MIS	10/120	0,93
703021501	2a MIS	10/120	1,09

## IVR LEVA ACC. AZZURRA



Leva blu in acciaio  
Blue handle in steel  
Blauer Hebelgriff aus Stahl  
Poignée bleue en acier  
Стальная ручка голубого цвета

Cod./Code	Mod./Model	□/田	€
700105001	3a MIS A	10/120	0,80
700115001	3a MIS B	10/120	1,02
700125001	3a MIS C	10/120	1,37
700135001	3a MIS D	10/120	1,93
700155001	3a MIS F	5/20	7,17
700415001	3/4" Zodiaco	10/120	0,86
700425001	1"1/4 Zodiaco	10/120	1,20
700435001	2" Zodiaco	10/120	1,84
700445001	7a MIS E	5/20	4,80

## IVR LEVA ACC. NERA



Leva nera in acciaio  
Black handle in steel  
Schwarzer Hebelgriff aus Stahl  
Poignée noire en acier  
Стальная ручка черного цвета

Cod./Code	Mod./Model	□/田	€
700102001	3a MIS A	10/120	0,78
700112001	3a MIS B	10/120	1,02
700122001	3a MIS C	10/120	1,37
700132001	3a MIS D	10/120	1,93
700152001	3a MIS F	5/20	7,17
700412001	3/4" Zodiaco	10/120	0,93
700422001	1"1/4 Zodiaco	10/120	1,21
700432001	2" Zodiaco	10/120	1,84
700442001	7a MIS E	5/20	4,80

## IVR LEVA ACC. ROSSA



Leva rossa in acciaio  
Red handle in steel  
Roter Hebelgriff aus Stahl  
Poignée rouge en acier  
Стальная ручка красного цвета

Cod./Code	Mod./Model	□/田	€
700101001	3a MIS A	10/120	0,80
700111001	3a MIS B	10/120	1,02
700121001	3a MIS C	10/120	1,37
700131001	3a MIS C	10/120	1,93
700151001	3a MIS F	5/20	7,17
700411001	3/4" Zodiaco	10/120	0,93
700421001	1"1/4 Zodiaco	10/120	1,21
700431001	2" Zodiaco	10/120	1,84
700441001	7a MIS E	5/20	4,80

## IVR LEVA ALL. NERA



Leva nera in alluminio  
Black handle in black  
Schwarzer Hebelgriff aus Aluminium  
Poignée noire en aluminium  
Алюминиевая ручка черного цвета

Cod./Code	L (mm)	□/田	€
700702001	85	10/120	1,25
700712001	110	10/120	1,62
700722001	130	10/120	3,49
700732001	160	10/60	4,63
701052001		5/20	9,88

## IVR CAPPuccio VERDE



Cappuccio sigillabile per IVR 120 121  
Seal cap for IVR 120 121  
Versiegelbarer Verschlusskappe für IVR 120 121  
Capouchon scellable pour IVR 120 121  
Колпачок под пломбировку для IVR 120 121

Cod./Code	Mod./Model	□/田	€
706017000	1a MIS	20/240	2,81
706027000	2a MIS	10/120	3,13
706037000	3a MIS	10/120	3,43

## IVR FARFALLA ALL. VERDE



Maniglia a farfalla verde in alluminio  
Green butterfly handle in aluminium  
Grüner Flügelgriff aus Aluminium  
Poignée papillon verte en aluminium  
Зеленая ручка "бабочка" из алюминия

Cod./Code	Mod./Model	□/田	€
703007001	Mignon	50/750	0,68
703017001	1a MIS	10/120	0,93
703027001	2a MIS	10/120	1,09

## IVR LEVA ACC. VERDE



Leva verde in acciaio  
Green handle in steel  
Grüner Hebelgriff aus Stahl  
Poignée verte en acier  
Стальная ручка зеленого цвета

Cod./Code	Mod./Model	□/田	€
700107001	3a MIS A	10/120	0,78
700117001	3a MIS B	10/120	1,02
700127001	3a MIS C	10/120	1,62
700137001	3a MIS D	10/120	1,93

## IVR MANIGLIA RIDUTT. VERDE



Maniglia riduttore di manovra con tappo verde  
Handle for ball valve with 360° handle without cap - Green Cap for handle  
Planetengriff mit grüner deckel  
Réducteur de manoeuvre avec bouchon verte  
Ручка редуктор

Cod./Code	Mod./Model	□/田	€
707007001	Mignon	5/30	8,85
707017001	1a MIS	5/30	8,86
707027001	2a MIS	5/30	8,86
707037001	3a MIS	5/20	13,40

## IVR 137 R



Maniglia senza tappo per valvola riduttore - Tappo per maniglia  
Handle for ball valve with 360° handle without cap - Cap for handle  
"Soft-Griff" ohne Deckel für Reduzierventil - Deckel für den Griff  
Poignée sans bouchon pour vanne réducteur - Bouchon pour poignée  
Ручка без пробки для клапана с редуктором - Пробка для ручки

Cod./Code	Mod./Model	Mis./Size	□/田	€
339003451	Mignon	3/8"	5/30	6,38
339005451	1a MIS	1/2" - 3/4"	5/30	6,38
339010451	2a MIS	1" - 1"1/4	5/30	6,38
339015451	3a MIS	1"1/2 - 2"	5/20	10,31
339005452	Cap 1a MIS Red		6/300	0,97
339010452	Cap 3a MIS Red		6/300	1,25

## IVR FARFALLA ALL. ARANCIO



Maniglia a farfalla arancione in alluminio  
Orange butterfly handle in aluminium  
Orangener Flügelgriff aus Aluminium  
Poignée papillon orange en aluminium  
Оранжевая ручка "бабочка" из алюминия

Cod./Code	Mod./Model	□/田	€
703004001	Mignon	10/120	0,74
703014001	1a MIS	10/120	0,93
703024001	2a MIS	10/120	1,09

## IVR LEVA ACC ARANCIO



Leva arancione in acciaio  
Orange handle in steel  
Oranger Hebelgriff aus Stahl  
Poignée orange en acier  
Стальная ручка оранжевого цвета

Cod./Code	Mod./Model	□/田	€
701604001	3a MIS A	10/120	1,10
701614001	3a MIS B	10/120	1,64
701624001	3a MIS C	10/120	2,40
701634001	3a MIS D	10/120	3,36

## IVR 130 R



Set ricambi parti cromate per valvole incasso con leva  
Set of chrome-plated spare parts for ball valves with handle for in-wall installations  
Ersatzteileset für verchromte Unterputzventilteile - Handhebel  
Kit de pièces de rechange chromées pour vannes à encastrer avec poignée  
Набор хромированных запасных частей для встраиваемых клапанов - с ручкой-флажком

Cod./Code	Mod./Model	□/田	€
911301001	Per Art. 130 - 1/2" 3/4" 1"	20/120	8,47



## IVR 134 R



Set ricambi parti cromate per valvole incasso con manopola  
Set of chrome-plated spare parts for ball valves with handle for in-wall installations  
Ersatzteileset für verchromte Unterputzventilteile - Drehknopf  
Kit de pièces de rechange chromées pour vannes à encastrer avec poignée  
Набор хромированных запасных частей для встраиваемых клапанов - с поворотной ручкой

Cod./Code	Mod./Model	□/⊕	€
911341001	Per Art. 134 - 1/2" 3/4" 1"	10/120	11,45

## IVR 135 R



Set ricambi parti cromate per valvole incasso con cappuccio  
Set of chrome-plated spare parts for ball valves with cap for in-wall installations  
Ersatzteileset für verchromte Unterputzventilteile - Kappe  
Kit de pièces de rechange chromées pour vannes à encastrer avec capuchon  
Набор хромированных запасных частей для встраиваемых клапанов - с конусным колпачком

Cod./Code	Mod./Model	□/⊕	€
911351001	Per Art. 135 - 1/2" 3/4" 1"	40/160	7,89

## IVR 42/43 R



Quadro manovra 28 mm per IVR 42- 43  
Square cap 28 mm for IVR 42 - 43  
Schalttafel 28 mm für IVR 42- 43  
Tableau de manoeuvre 28 mm pour IVR 42 - 43  
Квадратный хвостовик 28 мм для IVR 42 - 43

Cod./Code	Mod./Model	Mis./Size	□/⊕	€
705010001	1a MIS - 28mm	1/2" - 3/4"	10/120	6,71
705020001	2a MIS - 28mm	1" - 1"1/4	10/120	6,70
705030001	3a MIS - 28mm	1"1/2 - 2"	10/120	8,36

## IVR 966 R



Girello completo per Idretto IVR 966  
Hose union for bibcock for Idretto IVR 966  
Schlauchanschluss für Idretto IVR 966  
Jonction pour Idretto IVR 966  
Насадка для подключения шланга - для Idretto IVR 966

Cod./Code	Mis./Size	□/⊕	€
338005150	3/8" - 1/2"	20/200	1,05
338007150	3/4"	20/200	1,45
338010150	1"	20/100	2,55



## IVR 924 C



Cestello inox per filtro a Y in ottone IVR 924  
 Mesh for Y strainer in stainless steel IVR 924  
 Edelstahlkäfig für Y-förmigen Filter aus Gusseisen IVR 924  
 Panier inox pour filtre en Y en fonte IVR 924  
 Корзина из нержавеющей стали для фильтра типа "Y" из латуни IVR 924

Cod./Code	Mis./Size	□/⊞	€
334105001	1/2"	1/300	0,62
334107001	3/4"	1/250	1,25
334110001	1"	1/200	1,56
334112001	1"1/4	1/150	1,87
334115001	1"1/2	1/100	2,50
334120001	2"	1/50	3,75
334125001	2"1/2	1/60	4,37
334130001	3"	1/30	5,00
334140001	4"	1/12	5,62

## IVR DADO INOX



Dado in acciaio inox  
 Stainless steel nut  
 Mutter aus Inoxstahl  
 Ecrou en acier Inox  
 Гайка из нержавеющей стали

Cod./Code	Mod./Model	□/⊞	€
750306001	M 6x1	10/180	0,75
750308001	M 8x1,25	10/180	0,82
750310001	M 10 x1,25	10/180	1,25
750314001	M 14x1,5	10/180	2,25

## IVR DADO ACCIAIO



Dado in acciaio zincato  
 Zinc-plated steel nut  
 Mutter aus verzinktem Stahl  
 Ecrou en acier galvanisé  
 Стальная оцинкованная гайка

Cod./Code	Mod./Model	□/⊞	€
750106001	M 6x1	10/180	0,57
750108001	M 8x1,25	10/180	0,58
750110001	M 10x1,25	10/180	0,62
750114001	M 14x1,5	10/180	0,73
750116001	M 16x1,5	10/180	0,77
750118001	M 18x1,5	10/180	1,08



**VALVOLE GAS**  
GAS VALVES  
GASKUGELHÄHNE  
VANNES GAZ  
ЗАПОРНАЯ АРМАТУРА ДЛЯ ГАЗА



<b>IVR DIN</b>	<b>p. 185</b>
<b>IVR ELITE</b>	<b>p. 186</b>
<b>IVR ELITE ISO 7-1 RC</b>	<b>p. 189</b>
<b>IVR EXPORT ISO 7-1 RC</b>	<b>p. 191</b>
<b>IVR EVERGAS</b>	<b>p. 193</b>
<b>IVR PRESA PRESSIONE</b> <b><i>IVR PRESSURE GAUGE</i></b>	<b>p. 195</b>
<b>IVR RUBINETTI</b>	<b>p. 196</b>
<b>IVR GHISA</b> <b><i>IVR CAST-IRON</i></b>	<b>p. 199</b>
<b>RICAMBI LINEA GAS</b> <b><i>SPARE PARTS FOR GAS LINE</i></b>	<b>p. 202</b>



## IVR DIN

MOP 5-20

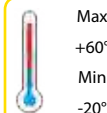

Max  
+60°  
Min  
-20°

UNI EN 10226-1  
(ISO 7-1 Rp)

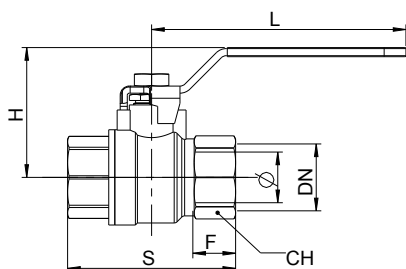

**IVR 100**

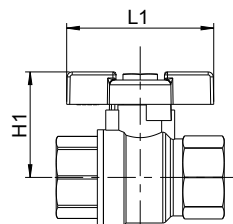

**IVR 100/A**

### DIMENSIONI / DIMENSIONS

DN	Ø	S	L	L1	H	H1	F	CH
3/8"	10	60	80	50	40	33	19	22
1/2"	15	75	90	61	52	39	23	26
3/4"	20	80	90	61	55	43	23,5	31
1"	25	90	125	72	64	52	24,5	40
1"1/4	32	110	125		69		31	49
1"1/2	40	120	140		78		32	55
2"	50	141	140		85		36	68

## IVR 100 DIN



Valvola a sfera per gas a passaggio totale omologata DVGW e HTB - attacchi F/F (DIN3357-4)  
Full bore ball valve for gas EN331 approved by DVGW and HTB - threaded ends F/F (DIN3357-4)  
Gas-Kugelhahn mit vollem Durchgang - DVGW- und HTB-Zulassung IG/IG (DIN3357-4)  
Vanne à boisseau sphérique à passage intégral certifiée DVGW et HTB - fixations F/F (DIN3357-4)  
Полнопроходной шаровой кран для газа (одобрено DVGW и HTB) - соединения В/В (DIN3357-4)

Cod./Code	Mis./Size	Ø	□/田	€
105003007	3/8"	10	10/120	7,52
105005007	1/2"	15	5/60	10,29
105007007	3/4"	20	15/60	13,74
105010007	1"	25	10/40	22,97
105012007	1"1/4	32	4/16	35,23
105015007	1"1/2	40	4/16	51,51
105020007	2"	50	2/8	83,04



## IVR 100/A DIN



Valvola a sfera per gas a passaggio totale omologata DVGW e HTB - attacchi F/F (DIN3357-4)  
Full bore ball valve for EN331 approved gas HTB - threaded ends F/F (DIN3357-4)  
Gas-Kugelhahn mit vollem Durchgang - DVGW- und HTB-Zulassung IG/IG (DIN3357-4)  
Vanne à boisseau sphérique à passage intégral certifiée HTB - fixations F/F (DIN3357-4)  
Полнопроходной шаровой кран для газа (одобрено DVGW и HTB) - соединения В/В (DIN3357-4)

Cod./Code	Mis./Size	Ø	□/田	€
105003002	3/8"	10	10/120	7,52
105005002	1/2"	15	5/60	10,29
105007002	3/4"	20	15/60	13,74
105010002	1"	25	10/40	22,97



### ACCESSORI / RICAMBI - ACCESSORIES / SPARE PARTS

	3/8"	1/2"	3/4"	1"	1"1/4	1"1/2	2"
	700103501	700113501	700113501	700123501	700123501	700133501	700133501
	703003501	703013501	703013501	703023501			
	750106001	750108001	750108001	750110001	750110001	750114001	750114001

Prezzi indicati nella sezione Accessori/Ricambi a fine capitolo / Prices in section Accessories/Spare Parts at the end of this chapter

## IVR ELITE

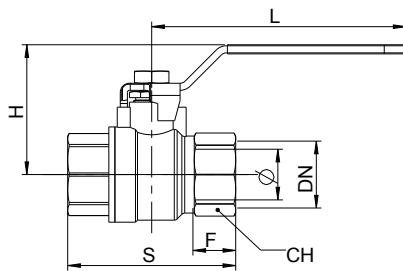
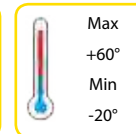

**IVR 100**

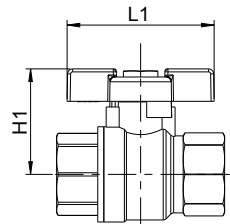

**IVR 100/A**

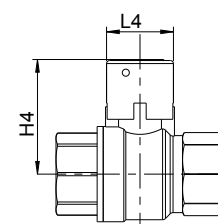

**IVR 182**

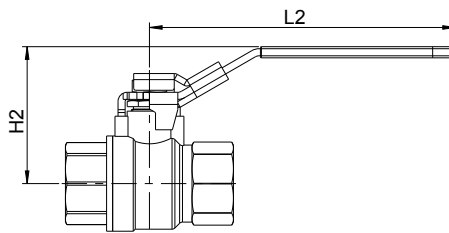

**IVR 100 LD**

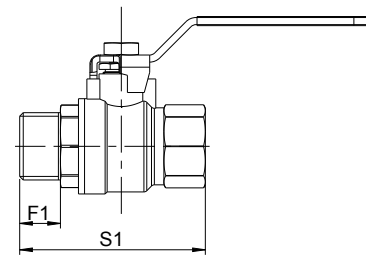

**IVR 101**

### DIMENSIONI / DIMENSIONS

DN	Ø	S	S1	L	L1	L2	L4	H	H1	H2	H4	F	F1	CH
1/4"	10	45	42	80	50	95		41	33	43		12	10	21
3/8"	10	45	54	80	50	95		41	33	43		12	12	21
1/2"	15	63	70	90	61	120	29	52	39	56	45	17	15	26
3/4"	20	71	80	90	61	120	29	55	43	60	49	19,5	16	31
1"	25	83	92	125	72	150	33	65		68	56	21	19	38
1 1/4"	32	92	102	125		150	33	69		73	61	22	20,5	48
1 1/2"	40	104	117	140		160	44	78		87	75	23,5	21,5	55
2"	50	124	137	140		160	44	85		94	82	28	24,5	68
2 1/2"	60	140		250				131				28		85
3"	74	159		250				140				30,5		99
4"	94	196		250				156				38		125

## IVR 100



Valvola a sfera per gas a passaggio totale HTB - attacchi F/F  
Full bore ball valve EN331 approved for gas HTB - threaded ends F/F  
Gas-Kugelhahn mit vollem Durchgang HTB - IG/IG  
Vanne à boisseau sphérique à passage intégral certifiée HTB - fixations F/F  
Полнопроходной шаровой кран для газа HTB - соединения В/В

Cod./Code	Mis./Size	Ø	□/⊞	€
110002013	1/4"	10	10/120	5,95
110003013	3/8"	10	10/120	5,55
110005013	1/2"	15	12/72	9,15
110007013	3/4"	20	15/60	12,56
110010013	1"	25	10/40	20,69
110012013	1 1/4"	32	6/24	30,66
110015013	1 1/2"	40	4/16	48,25
110020013	2"	50	2/8	74,11
110025013	2 1/2"	61	1/8	130,76
110030013	3"	74	1/6	182,46
110040013	4"	95	1/2	293,42





## IVR 100/A



Valvola a sfera per gas a passaggio totale HTB - attacchi F/F

Full bore ball valve EN331 approved for gas HTB - threaded ends F/F

Gas-Kugelhahn mit vollem Durchgang HTB - IG/IG

Vanne à boisseau sphérique à passage intégral certifiée HTB - fixations F/F

Полнопроходной шаровой кран для газа HTB - соединения В/В

Cod./Code	Mis./Size	Ø	□/田	€
110002001	1/4"	10	10/120	5,95
110003001	3/8"	10	10/120	5,55
110005001	1/2"	15	12/72	9,15
110007001	3/4"	20	15/60	12,56
110010001	1"	25	10/40	20,69



## IVR 101



Valvola a sfera per gas a passaggio totale HTB - attacchi M/F

Full bore ball valve EN331 approved for gas HTB - threaded ends M/F

Gas-Kugelhahn mit vollem Durchgang - HTB-Zulassung - AG/IG

Vanne à boisseau sphérique à passage intégral certifiée HTB - fixations M/F

Полнопроходной шаровой кран для газа HTB - соединения Н/В

Cod./Code	Mis./Size	Ø	□/田	€
110103013	3/8"	10	10/120	5,91
110105013	1/2"	15	12/72	9,46
110107013	3/4"	20	15/60	13,27
110110013	1"	25	10/40	21,64
110112013	1"1/4	32	6/24	33,18
110115013	1"1/2	40	4/16	52,64
110120013	2"	50	2/8	78,07



## IVR 101/A



Valvola a sfera per gas a passaggio totale HTB - attacchi M/F

Full bore ball valve EN331 approved for gas HTB - threaded ends M/F

Gas-Kugelhahn mit vollem Durchgang - HTB-Zulassung - AG/IG

Vanne à boisseau sphérique à passage intégral certifiée HTB - fixations M/F

Полнопроходной шаровой кран для газа HTB - соединения Н/В

Cod./Code	Mis./Size	Ø	□/田	€
110103001	3/8"	10	10/120	5,91
110105001	1/2"	15	12/72	9,46
110107001	3/4"	20	15/60	13,27
110110001	1"	25	10/40	21,64



## IVR 100 LD



Valvola a sfera a passaggio totale omologata HTB - attacchi F/F - con maniglia lucchettabile  
Full bore ball valve EN331 approved for gas HTB - threaded ends F/F - with lockable handle  
Kugelhahn mit vollem Durchgang Zulassung nach HTB IG/IG - mit verriegelbarem Hebel  
Vanne à boisseau sphérique à passage intégral certifiée HTB Fixations F/F - avec poignée cadenassable  
Полнопроходной шаровой кран для газа - одобрено HTB - соединения В/В - с запираемой рукояткой

Cod./Code	Mis./Size	Ø	□/⊕	€
110002762	1/4"	10	10/120	7,91
110003762	3/8"	10	10/120	7,51
110005762	1/2"	15	12/72	11,33
110007762	3/4"	20	15/60	14,76
110010762	1"	25	10/40	23,38
110012762	1"1/4	32	6/24	33,33
110015762	1"1/2	40	4/16	52,92
110020762	2"	50	2/8	78,77



## IVR 101 LD



Valvola a sfera a passaggio totale omologata HTB - attacchi M/F Con maniglia lucchettabile  
Full bore ball valve EN331 approved for gas HTB - threaded ends M/F - with lockable handle  
Kugelhahn mit vollem Durchgang Zulassung nach HTB AG/IG - mit verplombbarer Hebel  
Vanne à boisseau sphérique à passage intégral certifiée HTB Fixations M/F - avec poignée cadenassable  
Полнопроходной шаровой кран для газа - одобрено HTB - соединения Н/В - с запираемой рукояткой

Cod./Code	Mis./Size	Ø	□/⊕	€
110103762	3/8"	10	10/120	7,87
110105762	1/2"	15	12/48	11,66
110107762	3/4"	20	15/60	15,43
110110762	1"	25	10/40	24,32
110112762	1"1/4	32	6/24	35,96
110115762	1"1/2	40	4/16	57,30
110120762	2"	50	2/8	82,73



## IVR 182



Valvola a sfera a passaggio totale per gas con cappuccio piombabile - attacchi F/F  
Full bore ball valve EN331 approved for gas with seal cap - threaded ends F/F  
Gas-Kugelhahn mit vollem Durchgang mit verplombbarer Kappe IG/IG  
Vanne à boisseau sphérique à passage intégral pour gaz avec capuchon plombable fixations F/F  
Полнопроходной шаровой кран для газа с колпачком для пломбирования, соединения В/В

Cod./Code	Mis./Size	Ø	□/⊕	€
118205001	1/2"	15	10/60	11,24
118207001	3/4"	20	10/40	14,48
118210001	1"	25	10/40	23,59
118212001	1"1/4	32	6/24	33,40
118215001	1"1/2	40	5/20	48,93
118220001	2"	50	2/8	75,08



## IVR 183



Valvola a sfera a passaggio totale per gas con cappuccio piombabile - attacchi M/F -  
Full bore gas valve EN331 approved with sealing cap - threaded ends M/F  
Gaskugelhahn mit vollem Durchgang mit verplombbarer Kappe - AG/IG  
Vanne à boisseau sphérique pour gaz à passage intégral avec capuchon plombable fixations M/F  
Полнопроходной шаровой кран для газа с колпачком для пломбирования - соединения Н/В.

Cod./Code	Mis./Size	Ø	□/⊕	€
118305001	1/2"	15	10/60	11,48
118307001	3/4"	20	10/40	15,41
118310001	1"	25	10/40	24,45
118312001	1"1/4	32	6/24	37,01
118315001	1"1/2	40	5/20	53,31
118320001	2"	50	2/8	78,88



## IVR ELITE ISO 7-1 RC

MOP 5-20

Max  
+60°  
Min  
-20°

UNI EN 10226-2  
(ISO 7-1 Rc)

## IVR 190



Valvola a sfera per gas a passaggio totale HTB - attacchi F/F  
Full bore ball valve EN331 approved for gas HTB - threaded ends F/F  
Gas-Kugelhahn mit vollem Durchgang HTB - IG/IG  
Vanne à boisseau sphérique pour gaz à passage intégral HTB - fixations F/F  
Полнопроходной шаровой кран для газа HTB - соединения В/В

Cod./Code	Mis./Size	Ø	□/田	€
119002001	1/4"	10	10/120	5,73
119003001	3/8"	10	10/120	5,50
119005001	1/2"	15	12/72	9,13
119007001	3/4"	20	15/60	12,39
119010001	1"	25	10/40	20,27
119012001	1"1/4	32	6/24	30,06
119015001	1"1/2	40	4/16	47,55
119020001	2"	50	2/8	73,56



## IVR 190/A



Valvola a sfera per gas a passaggio totale HTB - attacchi F/F  
Full bore ball valve EN331 approved for gas HTB - threaded ends F/F  
Gas-Kugelhahn mit vollem Durchgang HTB - IG/IG  
Vanne à boisseau sphérique pour gaz à passage intégral HTB - fixations F/F  
Полнопроходной шаровой кран для газа HTB - соединения В/В

Cod./Code	Mis./Size	Ø	□/田	€
119002002	1/4"	10	10/120	5,73
119003002	3/8"	10	10/120	5,50
119005002	1/2"	15	12/72	9,13
119007002	3/4"	20	15/60	12,39
119010002	1"	25	10/40	20,27
119012002	1"1/4	32	6/24	30,06



## IVR 191



Valvola a sfera per gas a passaggio totale HTB - attacchi M/F  
Full bore ball valve EN331 approved for gas HTB - threaded ends M/F  
Gas-Kugelhahn mit vollem Durchgang HTB - AG/IG  
Vanne à boisseau sphérique pour gaz à passage intégral HTB - fixations M/F  
Полнопроходной шаровой кран для газа HTB - соединения Н/В

Cod./Code	Mis./Size	Ø	□/田	€
119103001	3/8"	10	10/120	5,81
119105001	1/2"	15	12/72	9,66
119107001	3/4"	20	15/60	13,27
119110001	1"	25	10/40	21,17
119112001	1"1/4	32	6/24	32,46
119115001	1"1/2	40	4/16	51,72
119120001	2"	50	4/16	76,42



## IVR 191/A







Valvola a sfera per gas a passaggio totale HTB - attacchi M/F  
Full bore ball valve EN331 approved for gas HTB - threaded ends M/F  
Gas-Kugelhahn mit vollem Durchgang HTB - AG/IG  
Vanne à boisseau sphérique pour gaz à passage intégral HTB - fixations M/F  
Полнопроходной шаровой кран для газа HTB - соединения Н/В

Cod./Code	Mis./Size	Ø	□/⊕	€
119103002	3/8"	10	10/120	5,81
119105002	1/2"	15	12/72	9,66
119107002	3/4"	20	15/60	13,27
119110002	1"	25	10/40	21,17
119112002	1"1/4	32	6/24	32,46



### ACCESSORI / RICAMBI - ACCESSORIES / SPARE PARTS

	1/4"	3/8"	1/2"	3/4"	1"	1"1/4	1"1/2	2"	2"1/2	3"	4"
	700103501	700103501	700113501	700113501	700123501	700123501	700133501	700133501	700443501	700443501	700153501
	703003501	703003501	703013501	703013501	703023501	703023501					
	125703907	125703907	125705907	125705907	125710907	125710907	125715907	125715907			
	750106001	750106001	750108001	750108001	750110001	750110001	750114001	750114001	750116001	750116001	
			706013501	706013501	706023501	706023501	706033501	706033501			

Prezzi indicati nella sezione Accessori/Ricambi a fine capitolo / Prices in section Accessories/Spare Parts at the end of this chapter

## IVR EXPORT ISO 7-1 RC

MOP 5-20

Max  
+60°  
Min  
-20°

UNI EN 10226-2  
(ISO 7-1 Rc)

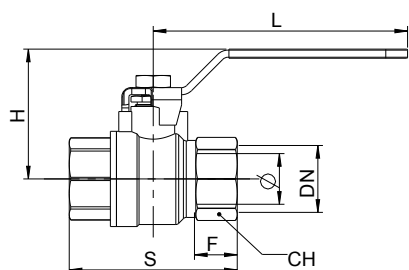

**IVR 45**

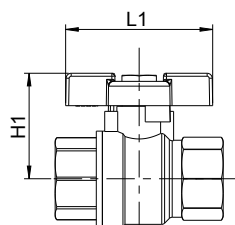

**IVR 45/A**

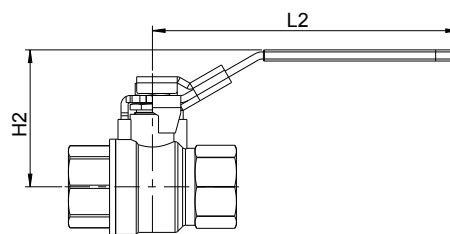

**IVR 45 LD**

### DIMENSIONI / DIMENSIONS

DN	Ø	S	L	L1	L2	H	H1	H2	F	CH
1/4"	10	45	80	50	95	41	33	43	12	21
3/8"	10	45	80	50	95	41	33	43	12	21
1/2"	15	63	90	61	120	52	39	56	17	26
3/4"	20	71	90	61	120	55	43	60	19,5	31
1"	25	83	125	72	150	65		68	21	38
1"1/4	32	92	125		150	69		73	22	48
1"1/2	40	104	140		160	78		87	23,5	55
2"	50	124	140		160	85		94	28	68

## IVR 45 GAS



Valvola a sfera a passaggio totale - attacchi F/F  
Full bore gas valve - threaded ends F/F RBSPT Threads  
Gaskugelhahn mit vollem Durchgang - IG/IG  
Vanne à boisseau sphérique à passage intégral - fixations F/F  
Полнопроходной шаровой кран для газа - соединения В/В.

Cod./Code	Mis./Size	Ø	□/田	€
104502008	1/4"	10	10/120	6,05
104503008	3/8"	10	10/120	5,43
104505008	1/2"	15	12/72	9,55
104507008	3/4"	20	15/60	13,05
104510008	1"	25	10/40	21,26
104512008	1"1/4	32	6/24	30,83
104515008	1"1/2	40	4/16	47,21
104520008	2"	50	2/8	73,49



## IVR 45/A GAS



Valvola a sfera a passaggio totale - attacchi F/F  
Full bore gas valve - threaded ends F/F - BSPT Threads  
Gaskugelhahn mit vollem Durchgang - IG/IG  
Vanne à boisseau sphérique à passage intégral - fixations F/F  
Полнопроходной шаровой кран для газа - соединения В/В.

Cod./Code	Mis./Size	Ø	□/田	€
104502005	1/4"	10	10/120	6,05
104503005	3/8"	10	10/120	5,43
104505005	1/2"	15	12/72	9,55
104507005	3/4"	20	15/60	13,05
104510005	1"	25	10/40	21,26



## IVR 45 LD GAS







Valvola a sfera a passaggio totale - attacchi F/F - con maniglia lucchettabile  
Full bore gas valve - threaded ends F/F - with lockable handle  
Gaskugelhahn mit vollem Durchgang - IG/IG - mit verriegelbarem Hebel  
Vanne à boisseau sphérique à passage intégral - fixations F/F - avec poignée cadenassable  
Полнопроходной шаровой кран для газа - соединения В/В - с запираемой рукояткой

Cod./Code	Mis./Size	Ø	□/⊞	€
104502757	1/4"	10	10/120	8,12
104503757	3/8"	10	10/120	7,47
104505757	1/2"	15	12/72	11,85
104507757	3/4"	20	15/60	15,25
104510757	1"	25	10/40	23,93
104512757	1"1/4	32	6/24	33,50
104515757	1"1/2	40	4/16	51,86
104520757	2"	50	4/16	77,90



### ACCESSORI / RICAMBI - ACCESSORIES / SPARE PARTS

	1/4"	3/8"	1/2"	3/4"	1"	1"1/4	1"1/2	2"
	700103001	700103001	700113001	700113001	700123001	700123001	700133001	700133001
	703003201	703003201	703013201	703013201	703023201			
	125703907	125703907	125705907	125705907	125710907	125710907	125715907	125715907
	750106001	750106001	750108001	750108001	750110001	750110001	750114001	750114001

Prezzi indicati nella sezione Accessori/Ricambi a fine capitolo / Prices in section Accessories/Spare Parts at the end of this chapter



## IVR EVERGAS

MOP 5-20

Max  
+60°  
Min  
-20°

UNI EN 10226-1  
(ISO 7-1 Rp)

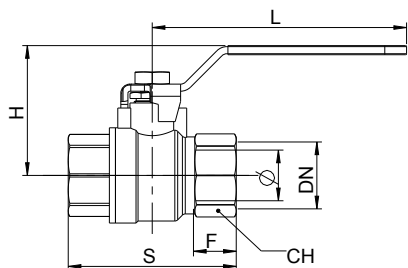

**IVR 151**

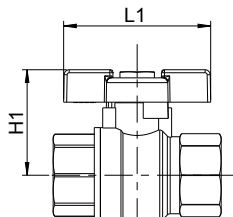

**IVR 151/A**

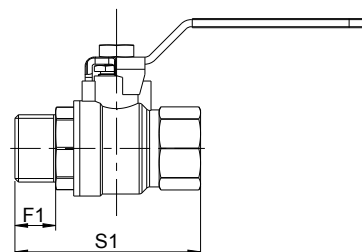

**IVR 152**

### DIMENSIONI / DIMENSIONS

DN	Ø	S	S1	L	L1	H	H1	F	F1	CH
1/2"	14	55	63,5	92	50	42,5	36	15	15	25
3/4"	18	61,5	69	92	50	45	39	16	16	31
1"	23	73	81,5	115	61	60	45	18	18	38
1"1/4	29	85,5	94,5	115		64		20,5	20,5	47
1"1/2	37	97	106	150		74,5		20,5	20,5	54
2"	47	117	129	150		81,5		25,5	25	66

## IVR 151



Valvola a sfera per gas a passaggio standard - attacchi F/F  
Standard bore ball valve EN331 approved for gas - threaded ends F/F  
Gas-Kugelhahn mit normalem Durchgang - IG/IG  
Vanne à boisseau sphérique pour gaz à passage normal - fixations F/F  
Шаровой кран для газа со стандартным проходом - соединения В/В

Cod./Code	Mis./Size	Ø	□/田	€
115105007	1/2"	14	12/72	6,99
115107007	3/4"	18	20/80	9,46
115110007	1"	23	12/48	16,68
115112007	1"1/4	29	8/32	25,23
115115007	1"1/2	37	4/16	37,70
115120007	2"	47	4/16	60,96



## IVR 151/A



Valvola a sfera per gas a passaggio standard - attacchi F/F  
Standard bore ball valve EN331 approved for gas - threaded ends F/F  
Gas-Kugelhahn mit normalem Durchgang - IG/IG  
Vanne à boisseau sphérique pour gaz à passage normal - fixations F/F  
Шаровой кран для газа со стандартным проходом - соединения В/В

Cod./Code	Mis./Size	Ø	□/田	€
115105008	1/2"	14	12/144	6,99
115107008	3/4"	18	20/80	9,46
115110008	1"	23	12/48	16,68



## IVR 152



Valvola a sfera per gas a passaggio standard - attacchi M/F  
Standard bore ball valve EN331 approved for gas - threaded ends M/F  
Gas-Kugelhahn mit normalem Durchgang - AG/IG  
Vanne à boisseau sphérique pour gaz à passage normal - fixations M/F  
Шаровой кран для газа со стандартным проходом - соединения Н/В

Cod./Code	Mis./Size	Ø	□/⊕	€
115205007	1/2"	14	12/72	7,49
115207007	3/4"	18	20/80	10,22
115210007	1"	23	12/48	18,04
115212007	1"1/4	29	6/24	28,13
115215007	1"1/2	37	4/16	39,39
115220007	2"	47	4/16	65,64



## IVR 152/A







Valvola a sfera per gas a passaggio standard - attacchi M/F  
Standard bore ball valve EN331 approved for gas - threaded ends M/F  
Gas-Kugelhahn mit normalem Durchgang - AG/IG  
Vanne à boisseau sphérique pour gaz à passage normal - fixations M/F  
Шаровой кран для газа со стандартным проходом - соединения Н/В

Cod./Code	Mis./Size	Ø	□/⊕	€
115205008	1/2"	14	12/144	7,49
115207008	3/4"	18	20/80	10,22
115210008	1"	23	12/48	18,04



### ACCESSORI / RICAMBI - ACCESSORIES / SPARE PARTS

	1/2"	3/4"	1"	1"1/4	1"1/2	2"
	700413501	700413501	700423501	700423501	700433501	700433501
	703003501	703003501	703013501	703013501		
	125703907	125703907	125705907	125705907	125710907	125710907
	750106001	750106001	750108001	750108001	750110001	750110001

Prezzi indicati nella sezione Accessori/Ricambi a fine capitolo / Prices in section Accessories/Spare Parts at the end of this chapter

## IVR PRESA PRESSIONE IVR PRESSURE GAUGE

MOP 5-20

Max  
+60°  
Min  
-20°

UNI EN 10226-1  
(ISO 7-1 Rp)

### IVR 212



Valvola a sfera con raccordo per presa pressione  
Full bore ball valve for gas with pressure gauge  
Kugelhahn mit Anschluss für Druckanschluss  
Vanne à boisseau sphérique avec raccord pour prise de pression  
Полнопроходной шаровой кран для газа с соединением для точки отбора

Cod./Code	Mis./Size	Ø	□/田	€
121205007	1/2"	15	10/40	11,91
121207007	3/4"	20	15/60	15,57
121210007	1"	25	10/40	24,05



### IVR 212/A



Valvola a sfera con raccordo per presa pressione  
Full bore ball valve for gas with pressure gauge  
Kugelhahn mit Anschluss für Druckanschluss  
Vanne à boisseau sphérique avec raccord pour prise de pression  
Полнопроходной шаровой кран для газа с соединением для точки отбора

Cod./Code	Mis./Size	Ø	□/田	€
121205008	1/2"	15	10/60	11,91
121207008	3/4"	20	20/80	15,57
121210008	1"	25	12/48	24,05



## IVR RUBINETTI

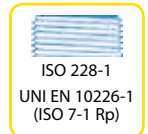
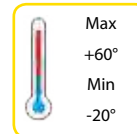

### IVR 110



Rubinetto a sfera a squadra per gas EN 14800:2007 - attacchi F/F  
Angle ball valve for gas with fastening for flexible metallic pipe EN 14800:2007 - threaded ends F/F  
Gas-Kugelhahn, eckförmig EN 14800:2007 - IG/IG  
Robinet à boisseau sphérique à équerre pour gaz EN 14800:2007 - fixations F/F  
Угловой шаровой кран для газа EN 14800:2007 - соединения В/В

Cod./Code	Mis./Size	□/⊕	€
111005001	1/2" x 1/2"	10/120	14,76



### IVR 111



Rubinetto a sfera a squadra per gas EN 14800:2007 - attacchi M/F  
Angle ball valve for gas with fastening for flexible metallic pipe EN 14800:2007 - threaded ends M/F  
Gas-Kugelhahn, eckförmig EN 14800:2007 - AG/IG  
Robinet à boisseau sphérique à équerre pour gaz EN 14800:2007 - fixations M/F  
Угловой шаровой кран для газа EN 14800:2007 - соединения Н/В

Cod./Code	Mis./Size	□/⊕	€
111105001	1/2"	10/120	12,97



### IVR 112



Rubinetto a sfera a squadra per gas EN 14800:2007 - attacchi M/M  
Angle ball valve for gas with fastening for flexible metallic pipe EN 14800:2007 - threaded ends M/M  
Gas-Kugelhahn, eckförmig EN 14800:2007 - AG/AG  
Robinet à boisseau sphérique à équerre pour gaz EN 14800:2007 - fixations M/M  
Угловой шаровой кран для газа EN 14800:2007 - соединения Н/Н

Cod./Code	Mis./Size	□/⊕	€
111205001	1/2"	10/120	13,05



### IVR 118



Rubinetto a sfera a squadra per gas EN 14800:2007 - attacchi M/F  
Angle ball valve for gas with fastening for flexible metallic pipe EN 14800:2007 - threaded ends M/F  
Gas-Kugelhahn, eckförmig EN 14800:2007 - AG/IG  
Robinet à boisseau sphérique à équerre pour gaz EN 14800:2007 - fixations M/F  
Угловой шаровой кран для газа EN 14800:2007 - соединения Н/В

Cod./Code	Mis./Size	∅	□/⊕	€
111805010	1/2" x 1/2"	13	10/120	9,04



## IVR 113



Rubinetto a sfera a squadra per gas EN 14800:2007 - attacchi M - Dado folle  
Angle ball valve EN 14800:2007 with M connection - Loose nut  
Gas-Kugelhahn, eckförmig EN 14800:2007 - Anschlüsse AG - Überwurfmutter  
Robinnet à boisseau sphérique à équerre pour gaz EN 14800:2007 - fixations M - écrou tournant  
Угловой шаровой кран для газа EN 14800:2007 - соединение H - Накидная гайка

Cod./Code	Mis./Size	Ø	□/田	€
111305015	1/2" x 1/2"	13	10/120	15,49
111305020	1/2" x 3/4"	13	10/120	15,24



## IVR 114



Rubinetto a sfera a squadra per gas EN 14800:2007 - attacchi F - Dado folle  
Angle ball valve EN 14800:2007 with F connection - Loose nut  
Gas-Kugelhahn, eckförmig EN 14800:2007 - Anschlüsse IG - Überwurfmutter  
Robinnet à boisseau sphérique à équerre pour gaz EN 14800:2007 - fixations F - écrou tournant  
Угловой шаровой кран для газа EN 14800:2007 - соединение B - Накидная гайка

Cod./Code	Mis./Size	□/田	€
111405015	1/2" x 1/2"	10/120	14,91
111405025	1/2" x 3/4"	10/120	15,38



## IVR 116



Rubinetto a sfera diritto per gas EN 14800:2007 - attacchi M - Dado folle  
Straight ball valve EN 14800:2007 with M connection - Loose nut  
Gas-Kugelhahn mit gerader Verschraubung EN 14800:2007 AG - Überwurfmutter  
Robinnet à boisseau sphérique droit pour gaz EN 14800:2007 - fixations M - écrou tournant  
Прямой шаровой кран для газа EN 14800:2007 - соединение H - Накидная гайка

Cod./Code	Mis./Size	Ø	□/田	€
111605010	1/2" x 1/2"	13	10/120	14,29
111605020	1/2" x 3/4"	13	10/120	14,91



## IVR 117



Rubinetto a sfera diritto per gas EN 14800:2007 - attacchi F - Dado folle  
Straight ball valve EN 14800:2007 with F connection - Loose nut  
Gas-Kugelhahn mit gerader Verschraubung EN 14800:2007 - Anschlüsse IG - Überwurfmutter  
Robinnet à boisseau sphérique droit pour gaz EN 14800:2007 - fixations F - écrou tournant  
Прямой шаровой кран для газа EN 14800:2007 - соединение B - Накидная гайка

Cod./Code	Mis./Size	□/田	€
111705015	1/2" x 1/2"	10/120	14,33
111705025	1/2" x 3/4"	10/120	14,76



## IVR 161



Rubinetto dritto per gas - attacchi F - portagomma  
Straight ball valve for gas - threaded ends F - Rubber hose connection  
Gas-Kugelhahn mit Schlauchanschluss - Anschluss IG  
Robinet a boisseau spherique pour gaz - fixations F - Porte tuyeau souple  
Прямой шаровой кран для газа - соединения В - насадка для резинового шланга

Cod./Code	Mis./Size	Ø	□/⊕	€
116103000	3/8" x 8	13	15/90	12,79
116103001	3/8" x 13	13	15/90	12,79
116105010	1/2" x 8	13	10/120	12,79
116105011	1/2" x 13	13	15/90	12,79



## IVR 162



Rubinetto dritto per gas - attacchi M - portagomma  
Straight ball valve for gas - threaded ends M - Rubber hose connection  
Gas-Kugelhahn mit gerader Verschraubung mit Schlauchanschluss - Anschluss AG  
Robinet a boisseau spherique pour gaz - fixations M - Porte tuyeau souple  
Прямой шаровой кран для газа - соединения Н - насадка для резинового шланга

Cod./Code	Mis./Size	Ø	□/⊕	€
116203000	3/8" x 8	13	15/90	12,79
116203002	3/8" x 13	13	15/90	12,79
116205010	1/2" x 8	13	10/120	12,79
116205012	1/2" x 13	13	10/120	12,79



## IVR 193



Rubinetto angolo per gas - attacchi F - Portagomma  
Angle ball valve for gas - threaded ends F - rubber hose connection  
Eckförmiger Gas-Kugelhahn mit Schlauchanschluss - Anschluss IG  
Robinet a equerre pour gaz - fixations F - porte tuyeau souple  
Прямой шаровой кран для газа - соединения В - насадка для резинового шланга

Cod./Code	Mis./Size	Ø	□/⊕	€
119305011	1/2" x 8	13	10/120	13,89
119305012	1/2" x 13	13	15/90	14,16



## IVR 194



Rubinetto angolo per gas - attacchi M - Portagomma  
Angle ball valve for gas - threaded ends M - rubber hose connection  
Eckförmiger Gas-Kugelhahn eckförmig mit Schlauchanschluss - Anschlüsse AG  
Robinet a equerre pour gaz - fixations M - porte tuyeau souple  
Угловой шаровой кран для газа - соединения Н - насадка для резинового шланга

Cod./Code	Mis./Size	Ø	□/⊕	€
119405011	1/2" x 8	13	10/120	13,60
119405012	1/2" x 13	13	10/120	13,89





**IVR GHISA  
IVR CAST-IRON**

PN16

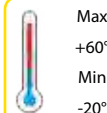

UNI EN 1092

**IVR 82**



Valvola a sfera in ghisa GJS 400 per gas - attacchi flangiati PN16  
Cast iron GJS 400 ball valve EN13 774 approved for gas - flanged ends PN16  
Kugelhahn aus Gusseisen GJS 400 für Gas - Flanschanschlüsse PN16  
Vanne à boisseau sphérique en fonte GJS 400 pour gaz - fixations bridées PN16  
Фланцевый шаровой кран для газа из чугуна GJS 400 - фланцевые соединения PN 16

Cod./Code	DN	Ø	ISO	□/田	€
108210052	25	25	F04	8	151,72
108212052	32	32	F04	5	167,16
108215052	40	40	F05	5	181,37
108220052	50	50	F05	3	207,68
108225052	65	61	F07	1/2	311,96
108230052	80	74	F07	1/2	385,54
108240052	100	95	F07	1	436,38
108250012	125	120	F10	1	812,12
108260012	150	145	F10	1	1.056,89



**IVR 82 + IVR 180**



IVR 82 - Valvola flangiata in ghisa GJS 400 per gas Attacchi flangiati PN 16 + IVR 180 - Riduttore di manovra manuale  
IVR 82 - Cast iron GJL 400 ball EN13 774 valve for gas - flanged ends PN 16 + IVR 180 - Manual gearbox  
IVR 82 - Flansch-Kugelhahn aus Gusseisen GJS 400 für Gas Flanschanschlüsse PN 16 + IVR 180 - Manuelles Getriebe  
IVR 82 - Vanne bride en fonte GJS 400 pour gaz Fixations bridées PN 16 + IVR 180 - Réducteur de manoeuvre manuelle  
IVR 82 Шаровой фланцевый кран для газа из чугуна GJS 400 - фланцевые соединения PN 16 + IVR 180 - Ручной редуктор управления

Cod./Code	DN	Ø	□/田	€
408215070	40	40	1	387,64
408220070	50	50	1	407,95
408225070	65	61	1	492,30
408230070	80	74	1	584,16
408240070	100	95	1	644,45
408250070	125	120	1	1.129,36
408260070	150	145	1	1.337,33



**IVR 83**



Valvola a sfera in ghisa GJS 400 per gas - asta e sfera inox - attacchi flangiati PN16  
Cast iron GJS 400 ball valve EN13 774 for gas - stainless steel stem and ball - flanged ends PN16  
Kugelhahn aus Gusseisen GJS 400 für Gas - Stab und Kugel aus Edelstahl - Flanschanschlüsse PN16  
Vanne à boisseau sphérique en fonte GJS 400 pour gaz - tige et sphère inox - fixations bridées PN16  
Фланцевый шаровой кран для газа из чугуна GJS 400 - Шток и шар из нержавеющей стали – фланцевые соединения PN 16

Cod./Code	DN	Ø	ISO	□/田	€
108307052	20	20	F10	10	130,78
108310052	25	25	F04	8	171,93
108312052	32	32	F04	5	190,35
108315052	40	40	F04	5	223,82
108320052	50	50	F05	3	261,08
108325052	65	61	F05	1/2	362,07
108330052	80	74	F07	1/2	462,39
108340052	100	95	F07	1	545,59
108350012	125	120	F07	1	992,64
108360012	150	145	F10	1	1.463,87



## IVR 83 + IVR 180



IVR 83 Valvola flangiata in ghisa GJS 400 per gas Asta e sfera inox - att. PN 16 + IVR 180 Riduttore di manovra manuale

IVR 83 - Cast iron GJS 400 ball valve EN13 774 for gas - s.s. stem and ball Flanged ends PN 16 + IVR 180 - Manual gearbox

IVR 83 Gas-Flansch-Kugelhahn aus Gusseisen GJS 400 - Stab und Kugel aus Edelstahl - Anschluss + IVR 180 Manuelles Getriebe

IVR 83 Vanne bride en fonte GJS 400 pour gaz - tige et sphère inox - att. PN 16 + Edelstahl - Anschluss PN IVR 180 Réducteur de manoeuvre manuelle

IVR 83 Шаровой фланцевый кран для газа из чугуна GJS 400 - Шток и шар из нержавеющей стали - фланцевые соединения PN 16 + IVR 180 - Ручной редуктор управления



Cod./Code	DN	Ø	□/田	€
408315070	40	40	1	435,75
408320070	50	50	1	466,35
408325070	65	61	1	570,59
408330070	80	74	1	676,69
408340070	100	95	1	764,12
408350070	125	120	1	1.316,80
408360070	150	145	1	1.770,17



## IVR 177



Valvola a farfalla in ghisa GJS 400 tipo LUG per gas

Butterfly valve for gas LUG type GJS 400

Ventil mit Flügelgriff aus Gusseisen GJS 400 Typ LUG für Gas

Vanne papillon en fonte GJS 400 type LUG pour gaz

Дисковый затвор Баттерфляй из чугуна GJS 400, для газа – тип LUG

Cod./Code	DN	Ø	ISO	□/田	€
117715001N	40	40	F05	8	81,24
117720001N	50	50	F05	5	85,51
117725001N	65	65	F05	1/2	100,19
117730001N	80	80	F05	1/2	107,86
117740001N	100	100	F07	1/2	157,04
117750001N	125	125	F07	1	209,84
117760001N	150	150	F07	1	239,32
117780001N	200	200	F10	1	399,80
417790001N	250	250	F10	1	712,14
417795001N	300	300	F10	1	944,71



## IVR 277 CF8M



Valvola a farfalla in ghisa GJS 400 tipo LUG per gas - disco inox CF8M

Butterfly valve for gas LUG type GJS 400 with SS disc CF8M

Ventil mit Flügelgriff aus Gusseisen GJS 400 Typ LUG für Gas - Edelstahlscheibe CF8M

Vanne papillon en fonte GJS 400 type LUG pour gaz disque inox CF8M

Дисковый затвор Баттерфляй для газа из чугуна GJS 400 - тип LUG - диск из нержавеющей стали CF8M

Cod./Code	DN	Ø	ISO	□/田	€
127715001N	40	40	F05	8	82,08
127720001N	50	50	F05	3	88,06
127725001N	65	65	F05	1/2	106,20
127730001N	80	80	F05	1/2	120,11
127740001N	100	100	F07	1/2	180,19
127750001N	125	125	F07	1	249,16
127760001N	150	150	F07	1	310,60
127780001N	200	200	F10	1	514,29
427790001N	250	250	F10	1	1.113,03
427795001N	300	300	F10	1	1.519,15



## IVR 178



Valvola a farfalla in ghisa GJS 400 tipo WAFER per gas  
Butterfly valve for gas WAFER type GJS 400  
Ventil mit Flügelgriff aus Gusseisen GJS 400 Typ WAFER für Gas  
Vanne papillon en fonte GJS 400 type WAFER pour gaz  
Дисковый затвор Баттерфляй из чугуна GJS 400, для газа - тип WAFER

Cod./Code	DN	Ø	ISO	□/田	€
117815001N	40	40	F05	8	77,90
117820001N	50	50	F05	6	81,43
117825001N	65	65	F05	1/3	94,73
117830001N	80	80	F05	1/2	101,87
117840001N	100	100	F07	1/2	149,70
117850001N	125	125	F07	1	199,82
117860001N	150	150	F07	1	228,16
117880001N	200	200	F10	1	383,14
417890001N	250	250	F10	1	438,92
417895001N	300	300	F10	1	573,12



## IVR 278 CF8M



Valvola a farfalla in ghisa GJS 400 tipo WAFER per gas - disco inox CF8M  
Butterfly valve for gas WAFER type GJS 400 with SS disc CF8M  
Ventil mit Flügelgriff aus Gusseisen GJS 400 Typ WAFER für Gas - Edelstahlscheibe CF8M  
Vanne papillon en fonte GJS 400 type WAFER pour gaz disque inox CF8M  
Дисковый затвор Баттерфляй для газа из чугуна GJS 400 - тип WAFER -диск из нержавеющей стали CF8M

Cod./Code	DN	Ø	ISO	□/田	€
127815001N	40	40	F05	8	78,05
127820001N	50	50	F05	4	84,05
127825001N	65	65	F05	1/3	100,83
127830001N	80	80	F05	1/2	114,32
127840001N	100	100	F07	1/2	172,98
127850001N	125	125	F07	1	239,32
127860001N	150	150	F07	1	299,72
127880001N	200	200	F10	1	497,92
427890001N	250	250	F10	1	810,94
427895001N	300	300	F10	1	1.107,34



## RICAMBI LINEA GAS SPARE PARTS FOR GAS LINE

### IVR FARFALLA ALL. GIALLA



Maniglia a farfalla gialla in alluminio  
Yellow butterfly handle in aluminium  
Gelber Flügelgriff aus Aluminium  
Poignée papillon jaune en aluminium  
Жёлтая ручка "бабочка" из алюминия

Cod./Code	Mod./Model	□/田	€
703003201	Mignon	10/120	0,74
703003501	Mignon	10/120	0,84
703013201	1a MIS	10/120	0,93
703013501	1a MIS	10/120	1,06
703023201	2a MIS	10/120	1,09
703023501	2a MIS	10/120	1,25

### IVR LEVA ACC GIALLA



Leva gialla in acciaio  
Yellow handle in steel  
Gelber Hebelgriff aus Stahl  
Poignée jaune en acier  
Стальная ручка желтого цвета

Cod./Code	Mod./Model	□/田	€
700103001	3a MIS A	10/120	0,78
700103501	3a MIS A	10/120	0,78
700113001	3a MIS B	10/120	1,00
700113501	3a MIS B	10/120	1,02
700123001	3a MIS C	10/120	1,37
700123501	3a MIS C	10/120	1,37
700133001	3a MIS D	10/120	1,93
700133501	3a MIS D	10/120	1,93
700153001	3a MIS F	5/20	7,17
700153501	3a MIS F	5/20	7,17
700413501	3/4" Zodiaco	10/120	0,93
700423501	1"1/4 Zodiaco	10/120	1,21
700433501	2" Zodiaco	10/120	1,84
700443501	4a MIS	5/20	4,80

### IVR 257



Maniglia lucchettabile. Anti-manomissione  
Lockable handle. Tamper proof  
Verriegelbarer Hebelgriff - Betätigungsschutz  
Poignée cadenassable. Anti-violation  
Запираемая ручка с защитой от взлома

Cod./Code	Mod./Model	□/田	€
125703907	MIGNON	10/120	2,55
125705907	1a MIS	10/120	3,12
125710907	2 MIS	10/60	3,95
125715907	3 MIS	10/40	6,80



### IVR CAPPUCCIO GIALLO



Cappuccio piombabile per IVR 182 183  
Seal cap for IVR 182 183  
Versiegelbarer Verschlusskappe für IVR 182 183  
Capouchon scellable pour IVR 182 183  
Колпачок под пломбировку для IVR 182 183

Cod./Code	Mod./Model	□/田	€
706013501	1a MIS	20/240	2,81
706023501	2a MIS	10/120	3,13
706033501	3a MIS	10/120	3,43

## IVR GUA 82/83



Kit di guarnizioni di ricambio per valvole a sfera in ghisa per gas IVR 82 83  
Kit of washer spare parts for gas ball valves in cast iron IVR 82 83  
Garnitur von Ersatzdichtungen für Gaskugelhähne IVR 82 83  
Kit de joints de rechange pour vanne à boisseau sphérique pour gaz IVR 82 83  
Комплект сменных прокладок для газового крана из чугуна для IVR 82 - 83

Cod./Code	Mod./Model	□/田	€
334206071	Per DN 20	10/120	7,23
334206101	Per DN 25	10/120	8,22
334206121	Per DN 32	10/120	7,42
334206151	Per DN 40	10/120	10,58
334206201	Per DN 50	5/50	10,57
334206251	Per DN 65	5/50	18,07
334206301	Per DN 80	5/50	27,50
334206401	Per DN100	5/50	30,95
334206501	Per DN125	1/4	89,16
334206601	Per DN150	1/4	140,75

## IVR LEVA ACCIAIO GIALLA ART 82-83



Leva nera in acciaio per IVR 82 83  
Black handle in steel for IVR 82 83  
Schwarzer Hebelgriff aus Stahl für IVR 82 83  
Poignée noire en acier IVR 82 83  
Стальная ручка черного цвета для IVR 82 - 83

Cod./Code	Mod./Model	□/田	€
702023501	G/2	100	2,50
702033501	G/3	50	3,34
702053501	G/5	30	5,29
702063501	G/6	10	16,91

## IVR VITI ACCIAIO



Vite in acciaio per IVR 82 83  
Steel screw for IVR 82 83  
Schraube aus Stahl für IVR 82 83  
Vis en acier pour IVR 82 83  
Стальной винт для IVR 82- 83

Cod./Code	Mod./Model	□/田	€
750600801	M 8x12	10/180	0,84
750601001	M 10x20	10/180	0,78
750720601	M 6x12	10/180	1,45
750730801	M 8x12	10/180	3,84
750740801	M 8x12	10/180	3,05
750751001	M 10x20	10/180	4,19

## IVR LEVA GIALLA WAFER LUG



Leva gialla per valvole gas tipo Wafer e LUG  
Yellow handle for Wafer and LUG gas valves  
Gelber Hebelgriff für Gaskugelhähne Typ Wafer und LUG  
Poignée jaune pour vannes pour gaz type Wafer et LUG  
Ручка жёлтого цвета для газовых клапанов модели WAFER и LUG

Cod./Code	Mod./Model	□/田	€
702335151	per DN 40-50	10	15,28
702335251	per DN 65-80	10	15,28
702335401	per DN 100	10	15,28
702335501	per DN 125-150	10	15,28
702335801	per DN 200	5	27,50
702335901	per DN 250-300	5	40,07



**VALVOLE GAS**  
GAS VALVES  
GASKUGELHÄHNE  
VANNES GAZ  
ЗАПОРНАЯ АРМАТУРА ДЛЯ ГАЗА





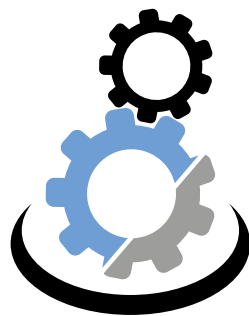

**VALVOLE INDUSTRIALI**  
INDUSTRIAL VALVES  
INDUSTRIEKUGELHÄHNE UND VENTILE  
VANNES INDUSTRIE  
ИНДУСТРИАЛЬНАЯ ЗАПОРНАЯ АРМАТУРА



<b>INOX</b>	<b>p. 207</b>
<b>GHISA</b> <b>CAST-IRON</b>	<b>p. 213</b>
<b>GIUNTI ANTIVIBRANTI</b> <b>ANTI-VIBRATION JOINT</b>	<b>p. 220</b>
<b>ACCESSORI VALVOLE INDUSTRIALI</b> <b>ACCESSORIES FOR INDUSTRIAL VALVES</b>	<b>p. 221</b>
<b>VALVOLE INDUSTRIALI CON ATTUATORI ELETTRICI</b> <b>INDUSTRIAL VALVES WITH ELECTRIC ACTUATORS</b>	<b>p. 222</b>
<b>VALVOLE INDUSTRIALI CON ATTUATORI PNEUMATICI</b> <b>INDUSTRIAL VALVES WITH PNEUMATIC ACTUATORS</b>	<b>p. 230</b>
<b>ACCESSORI PER ATTUATORI INDUSTRIALI</b> <b>ACCESSORIES FOR INDUSTRIAL ACTUATORS</b>	<b>p. 241</b>
<b>RICAMBI LINEA INDUSTRIA</b> <b>SPARE PARTS FOR INDUSTRIAL LINE</b>	<b>p. 242</b>



## INOX

### IVR 660



Valvola a sfera a passaggio totale in acciaio inox AISI 316 - attacchi F/F - disponibile con filettatura NPT (ultima cifra del codice 5)

Full bore ball valve in stainless steel AISI 316 - threaded ends F/F - available with NPT threaded end (the last digit of code is 5)

Kugelhahn mit vollem Durchgang aus Edelstahl AISI 316 - IG/IG - mit NPT (die letzte Nummer von der Artikelnummer ist 5)

Vanne à boisseau sphérique à passage intégral en acier inox AISI 316 - fixations F/F - fournissables avec la fixation NPT (la dernière chiffre du numéro de l'article est 5)

Полнопроходной шаровой кран из нержавеющей стали AISI 316 - Соединения В/В - доступный с резьбой NPT (последняя цифра кода 5)

Cod./Code	Mis./Size	Ø	□/田	€
166002001	1/4"	12	20/120	17,53
166003001	3/8"	13	15/90	17,53
166005001	1/2"	15	12/72	18,41
166007001	3/4"	20	8/48	26,01
166010001	1"	25	4/24	37,83
166012001	1"1/4	32	9/18	56,72
166015001	1"1/2	40	6/12	77,52
166020001	2"	50	4/8	114,91
166025001	2"1/2	65	1/4	231,66
166030001	3"	76	1/4	312,05
166040001	4"	94	1	576,34



### IVR 662



Valvola a sfera a passaggio totale in acciaio inox AISI 316 - attacchi F/F - Flangia ISO 5211

Full bore ball valve in stainless steel AISI 316 - F/F - Flange ISO 5211

Kugelhahn mit vollem Durchgang aus rostfreiem Stahl AISI 316 - IG/IG - Flansche ISO 5211

Vanne à boisseau sphérique avec passage total en acier inox AISI 316 - F/F - Bride ISO 5211

Кран шаровой полнопроходной из нержавеющей стали AISI 316 -соединения В/В- фланец ISO 5211

Cod./Code	Mis./Size	Ø	□/田	€
166202001	1/4"	12	10/60	27,99
166203001	3/8"	13	10/60	27,99
166205001	1/2"	15	10/60	27,99
166207001	3/4"	20	8/48	34,37
166210001	1"	25	4/24	48,62
166212001	1"1/4	32	12/24	68,30
166215001	1"1/2	40	6/12	100,24
166220001	2"	50	3/6	139,04
166225001	2"1/2	65	1/4	262,82
166230001	3"	76	1/2	345,34
166240001	4"	94	1	612,55



## IVR 665



Valvola a sfera a passaggio totale in tre pezzi in acciaio inox AISI 316 - attacchi F/F - flangia ISO 5211

Three-piece full bore ball valve in stainless steel AISI 316 - threaded ends F/F - ISO 5211 flange

Kugelhahn dreiteilig mit vollem Durchgang aus Edelstahl AISI 316 - IG/IG - Flansch ISO 5211

Vanne à boisseau sphérique à passage intégral en trois pièces en acier inox AISI 316 - fixations F/F - bride ISO 5211

Трёхсоставной полнопроходной шаровой кран из нержавеющей стали AISI 316 - Соединения В/В - фланец ISO 5211

Cod./Code	Mis./Size	Ø	ISO	□/田	€
166502001	1/4"	11	F03	10/60	30,73
166503001	3/8"	13	F03	10/60	30,73
166505001	1/2"	15	F03/F04	8/48	33,59
166507001	3/4"	20	F04/F05	3/18	50,15
166510001	1"	25	F04/F05	3/18	63,36
166512001	1"1/4	32	F04/F05	4/8	93,13
166515001	1"1/2	40	F05/F07	4/8	122,91
166520001	2"	50	F05/F07	3/6	165,48
166525001	2"1/2	65	F07/F10	1/2	344,69
166530001	3"	80	F07/F10	1/2	505,93
166540001	4"	100	F07/F10	1	774,02



## IVR 663



Valvola a sfera a passaggio totale in tre pezzi in acciaio inox AISI 316 - attacchi F/F - flangia ISO 5211

Three-piece full bore ball valve in stainless steel AISI 316 - F/F - ISO 5211 flange

Kugelhahn dreiteilig mit vollem Durchgang aus Edelstahl AISI 316 - IG/IG - Flansch ISO 5211

Vanne à boisseau sphérique à passage intégral en trois pièces en acier inox AISI 316 - F/F - bride ISO 5211

Трёхсоставной полнопроходной шаровой кран из нержавеющей стали AISI 316 - Соединения В/В - фланец ISO 5211

Cod./Code	Mis./Size	□/田	€
166302001	1/4"	6/36	44,68
166303001	3/8"	6/36	44,68
166305001	1/2"	6/36	44,68
166307001	3/4"	8/16	66,30
166310001	1"	8/16	86,94
166312001	1"1/4	3/6	137,02
166315001	1"1/2	3/6	191,07
166320001	2"	5	259,86



## IVR 670



Valvola a sfera a passaggio totale in tre pezzi in acciaio inox AISI 316 - attacchi a saldare - flangia ISO 5211

Three-piece full bore ball valve in stainless steel AISI 316 - Butt weld connections - ISO 5211 flange

Kugelhahn dreiteilig mit vollem Durchgang aus Edelstahl AISI 316 - Schweissenden - Flansch ISO 5211

Vanne à boisseau sphérique à passage intégral en trois pièces en acier inox AISI 316 - fixations F/F - bride ISO 5211

Трёхсоставной полнопроходной шаровой кран из нержавеющей стали AISI 316 - Соединения под приварку - фланец ISO 5211

Cod./Code	Mis./Size	Ø	ISO	□/田	€
167002001	1/4"	11	F03	10/60	29,77
167003001	3/8"	13	F03	10/60	29,77
167005001	1/2"	15	F03/F04	8/48	32,63
167007001	3/4"	20	F04/F05	3/18	48,66
167010001	1"	25	F04/F05	3/18	61,92
167012001	1"1/4	32	F05/F07	4/8	90,80
167015001	1"1/2	40	F05/F07	4/8	120,11
167020001	2"	50	F05/F07	3/6	161,70
167025001	2"1/2	65	F07/F10	1/2	337,09
167030001	3"	80	F07/F10	1/2	495,05
167040001	4"	100	F07/F10	1	756,51



## IVR 672



Valvola a sfera a passaggio totale in tre pezzi in acciaio inox AISI 316 - attacchi a saldare di tasca - flangia ISO 5211

Three-piece full bore ball valve in stainless steel AISI 316 - Socket weld connection - ISO 5211 flange

Kugelhahn dreiteilig mit vollem Durchgang aus Edelstahl AISI 316 - Schweißanschlüsse - Flansch ISO 5211

Vanne à boisseau sphérique à passage intégral en trois pièces en acier inox AISI 316 - fixations à souder de poche - bride ISO 5211

Трёхсоставной полнопроходной шаровой кран из нержавеющей стали AISI 316 - Соединения под приварку (карман) - фланец ISO 5211

Cod./Code	Mis./Size	Ø	ISO	□/田	€
167202001	1/4"	11	F03	10/60	31,28
167203001	3/8"	13	F03	10/60	31,28
167205001	1/2"	15	F03/F04	8/48	34,18
167207001	3/4"	20	F04/F05	3/18	51,03
167210001	1"	25	F04/F05	3/18	64,51
167212001	1"1/4	32	F05/F07	4/8	94,85
167215001	1"1/2	40	F05/F07	4/8	125,16
167220001	2"	50	F05/F07	3/6	168,49
167225001	2"1/2	65	F07/F10	1/2	350,93
167230001	3"	80	F07/F10	1/2	509,99
167240001	4"	100	F07/F10	1	812,14



## IVR 144 L



Valvola a sfera in acciaio inox AISI 316 tre vie passaggio ridotto - sfera forata a L - attacchi F/F/F - flangia ISO 5211

3-way reduced bore ball valve in stainless steel AISI 316 - Bored ball as L - threaded ends F/F/F - ISO 5211 flange

3-Wege-Kugelhahn aus Edelstahl AISI 316 mit reduziertem Durchgang - Kugel mit L-Bohrung - IG/IG - Flansch ISO 5211

Vanne à boisseau sphérique à passage réduit - sphère percée en L - fixations F/F/F - bride ISO 5211

Трёхходовой шаровой кран из нерж. стали AISI 316 с редуцированным проходом - L-образный проход шара - Соединения В/В/В - фланец ISO 5211

Cod./Code	Mis./Size	Ø	ISO	□/田	€
114402001	1/4"	10	F03/F04	6/36	69,04
114403001	3/8"	10	F03/F04	6/36	69,04
114405001	1/2"	12	F03/F04	6/36	69,04
114407001	3/4"	15	F04/F05	3/18	89,85
114410001	1"	20	F04/F05	2/12	123,92
114412001	1"1/4	25	F05/F07	12	214,14
114415001	1"1/2	32	F05/F07	6	262,92
114420001	2"	40	F05/F07	4	434,02



## IVR 145 T



Valvola a sfera in acciaio inox AISI 316 tre vie passaggio ridotto - sfera forata a T - attacchi F/F/F - flangia ISO 5211

3-way reduced bore ball valve in stainless steel AISI 316 - Bored ball as T - threaded ends F/F/F - ISO 5211 flange

3-Wege-Kugelhahn aus Edelstahl AISI 316 mit reduziertem Durchgang - Kugel mit T-Bohrung - IG/IG - Flansch ISO 5211

Vanne à boisseau sphérique en acier inox AISI 316 trois voies passage réduit - sphère percée en T - fixations F/F/F - bride ISO 5211

Трёхходовой шаровой кран из нерж. стали AISI 316 с редуцированным проходом - T-образный проход шара - Соединения В/В/В - фланец ISO 5211

Cod./Code	Mis./Size	Ø	ISO	□/田	€
114502001	1/4"	10	F03/F04	6/36	69,04
114503001	3/8"	10	F03/F04	6/36	69,04
114505001	1/2"	12	F03/F04	6/36	69,04
114507001	3/4"	15	F04/F05	3/18	89,85
114510001	1"	20	F04/F05	2/12	123,39
114512001	1"1/4	25	F05/F07	12	212,77
114515001	1"1/2	32	F05/F07	6	260,99
114520001	2"	40	F05/F07	4	428,38



## IVR 685



Valvola a sfera a corpo piatto in acciaio inox AISI 316 - Flangia ISO 5211 e attacchi flangiati PN 16

AISI 316 stainless steel ball valve - ISO 5211 flange - Flanged ends PN16

Kugelhahn mit Flachkörper aus Edelstahl AISI 316 - Flansch ISO 5211 und Flanschschlüsse PN 16

Vanne à boisseau sphérique à corps plat en acier inox AISI 316 - Bride ISO 5211 et fixations bridées PN 16

Шаровой кран с укороченным корпусом из нержавеющей стали AISI 316 - фланец ISO 5211 - Фланцевое соединение PN 16

Cod./Code	DN	Ø	ISO	□/田	€
168505001	15	15	F03	9/18	80,40
168507001	20	20	F03	8/16	98,35
168510001	25	25	F04/F05	6/12	119,15
168512001	32	32	F04/F05	8	147,54
168515001	40	40	F05/F07	5	199,55
168520001	50	50	F05/F07	4	268,53
168525001	65	65	F07/F10	1/3	405,67
168530001	80	76	F07/F10	1/2	548,96
168540001	100	94	F07/F10	1/2	904,47
168550001	125	125	F10/F12	1	1.726,69
168560001	150	150	F10/F12	1	2.267,59



## IVR 664



Valvola a sfera in due pezzi in acciaio inox AISI 316 - attacchi flangiati - flangia ISO 5211

Two-piece ball valve in stainless steel AISI 316 - flanged connections - ISO 5211 flange

Zweitelliger Kugelhahn aus rostfreiem Stahl AISI 316 mit Flanschschlüssen - Flansche ISO 5211

Vanne à boisseau sphérique à deux pièces en acier inox AISI 316 - fixations bridées - bride ISO 5211

Двухсоставной полнопроходной шаровой кран из нержавеющей стали AISI 316 - фланцевые соединения - фланец ISO 5211

Cod./Code	DN	Ø	ISO	□/田	€
166405001	15	15	F03/F04	12	116,46
166407001	20	20	F03/F04	6	156,70
166410001	25	25	F04/F05	6	199,93
166412001	32	32	F04/F05	4	286,39
166415001	40	40	F05/F07	4	341,40
166420001	50	50	F05/F07	2	458,81
166425001	65	65	F07/F10	1/2	737,31
166430001	80	76	F07/F10	1/2	906,81
166440001	100	94	F07/F10	1	1.244,76



## IVR 667



Valvola a sfera in tre pezzi in acciaio inox AISI 316 - attacchi flangiati

Three-piece ball valve in stainless steel AISI 316 - flanged connections

Kugelhahn dreiteilig aus rostfreiem Stahl AISI 316 - geflanschten Gewinden

Vanne à boisseau sphérique en acier inox AISI 316 - fixations bridées

Трёхсоставной кран из нержавеющей стали AISI 316 - фланцевые соединения

Cod./Code	DN	Ø	ISO	□/田	€
166705001	15	15	F03	8	89,93
166707001	20	20	F03	6	133,14
166710001	25	25	F04/F05	4	169,94
166712001	32	32	F04/F05	3	246,09
166715001	40	40	F05/F07	2	296,71
166720001	50	50	F05/F07	2	408,72
166725001	65	65	F07/F10	1	652,37
166730001	80	76	F07/F10	1	844,96
166740001	100	94	F07/F10	1	1.240,41





## IVR 668



CE

Valvola a sfera in tre pezzi in acciaio inox AISI 316 - attacchi flangiati - flangia ISO 5211  
Three-piece ball valve in stainless steel AISI 316 - flanged connections - flange ISO 5211  
Kugelhahn dreiteilig aus Inoxstahl AISI 316 - mit geflanschten Gewinden - Flansche ISO 5211  
Vanne à boisseau sphérique en trois pièces en acier inox AISI 316 - fixations bridées - bride ISO 5211  
Трёхсоставной кран из нержавеющей стали AISI 316 - фланцевые соединения - фланец ISO 5211

Cod./Code	DN	Ø	ISO	□/⊞	€
166805001	15	15	F03	8/16	94,78
166807001	20	20	F03	6/12	140,49
166810001	25	25	F04/F05	4/8	171,45
166812001	32	32	F04/F05	3	258,41
166815001	40	40	F05/F07	2	303,09
166820001	50	50	F05/F07	2	413,58
166825001	65	65	F07/F10	1	684,30
166830001	80	76	F07/F10	1	884,23
166840001	100	94	F07/F10	1	1.273,27



## IVR 655



CE

Valvola di ritegno in acciaio inox AISI 316 - attacchi F/F  
Stainless steel AISI 316 vertical check valve - threaded ends F/F  
Rückschlagventil aus Edelstahl AISI 316 - IG/IG  
Vanne de retenue en acier inox AISI 316 - fixations F/F  
Вертикальный обратный клапан из нержавеющей стали AISI 316 - Соединения В/В

Cod./Code	Mis./Size	Ø	□/⊞	€
165502001	1/4"	8	30/180	19,37
165503001	3/8"	10	30/180	19,37
165505001	1/2"	15	25/150	20,32
165507001	3/4"	20	20/120	26,49
165510001	1"	25	10/60	34,50
165512001	1"1/4	32	8/48	50,15
165515001	1"1/2	38	5/30	69,04
165520001	2"	47	3/18	91,70
165525001	2"1/2	61	1/10	162,14
165530001	3"	75	1/6	241,15
165540001	4"	94	1/3	393,41



## IVR 656



CE

Valvola di ritegno a molla interflangia tipo WAFER in acciaio inox AISI 316  
Stainless steel AISI 316 single disc WAFER spring check valve  
Rückschlagventil mit Scheibenklappe, Typ WAFER aus Edelstahl AISI 316  
Vanne de retenue à ressort entre-bride type WAFER en acier inox AISI 316  
Пружинный межфланцевый обратный клапан из нержавеющей стали AISI 316 - тип WAFER

Cod./Code	DN	Ø	□/⊞	€
165605001	15	15	60/360	14,65
165607001	20	20	40/240	17,04
165610001	25	25	25/150	22,66
165612001	32	32	15/90	34,07
165615001	40	40	10/60	45,90
165620001	50	49	4/24	64,31
165625001	65	62	1/28	94,57
165630001	80	75	1/15	135,21
165640001	100	95	1/9	197,63
165650001	125	118	1	409,44
165660001	150	140	1	594,34
165680001	200	185	1	1.122,44



## IVR 687



Valvola di ritegno a clapet senza molla, tipo WAFER in acciaio inox AISI 316

Stainless steel AISI 316 single disc WAFER, swing check valve

Rückschlagventil mit Klappe ohne Feder, Typ WAFER aus Edelstahl AISI 316

Vanne de retenue à clapet sans ressort, type WAFER en acier inox AISI 316

Межфланцевый обратный клапан из нержавеющей стали AISI 316 - без пружины - тип WAFER

Cod./Code	DN	Ø	□/田	€
168712001	32	20	1/25	57,69
168715001	40	25	1/25	66,17
168720001	50	32	1/25	78,97
168725001	65	40	1/25	100,68
168730001	80	54	1/10	118,18
168740001	100	70	1/10	181,08
168750001	125	92	1/10	256,16
168760001	150	114	1/3	321,03
168780001	200	154	1/3	521,48
168790001	250	200	1/2	815,59
168795001	300	230	1/2	1.317,25



## IVR 654



Valvola a clapet a passaggio totale in acciaio inox AISI 316 - attacchi F/F

Full bore swing check valve in stainless steel AISI 316 - threaded ends F/F

Rückschlagventil bzw. Klappe mit vollem Durchgang aus Edelstahl AISI 316 - IG/IG

Vanne à clapet à passage intégral en acier inox AISI 316 - fixations F/F

Полнопроходной обратный клапан из нержавеющей стали AISI 316 - Соединения В/В

Cod./Code	Mis./Size	Ø	□/田	€
165402001	1/4"	10	12/72	25,52
165403001	3/8"	12	12/72	25,52
165405001	1/2"	15	12/72	25,52
165407001	3/4"	20	8/48	31,69
165410001	1"	25	6/36	39,70
165412001	1"1/4	32	4/24	67,61
165415001	1"1/2	40	8/16	83,21
165420001	2"	50	5/10	112,52



## IVR 657



Filtro a Y a passaggio totale in acciaio inox AISI 316 - attacchi F/F

Strainer in stainless steel AISI 316 - threaded ends F/F

Full bore check valve in stainless steel AISI 316 - threaded ends F/F

Filtre en Y à passage total en acier inox AISI 316 - fixations F/F

Полнопроходной фильтр "Y" из нержавеющей стали - Соединения В/В

Cod./Code	Mis./Size	Ø	□/田	€
165702001	1/4"	10	25/150	17,04
165703001	3/8"	12	25/150	17,04
165705001	1/2"	15	25/150	17,04
165707001	3/4"	20	12/72	23,62
165710001	1"	25	8/48	34,97
165712001	1"1/4	32	14/28	47,28
165715001	1"1/2	40	12/24	60,08
165720001	2"	50	4/8	86,09



## GHISA CAST-IRON

### IVR 77



Valvola a sfera in ghisa GJL 250 - attacchi flangiati PN 16  
Cast iron GJL 250 ball valve - Flanged ends PN 16 - Mounting flange ISO 5211  
Kugelhahn aus Gusseisen GJL 250 - Flanschanschlüsse PN 16  
Vanne à boisseau sphérique en fonte GJL 250 - fixations bridées PN 16  
Шаровой кран из чугуна GJL 250 - Фланцевое соединение PN 16

Cod./Code	DN	Ø	ISO	□/田	€
107707051	20	20	F04	10	124,61
107710051	25	25	F04	8	145,02
107712051	32	32	F04	5	153,94
107715051	40	40	F05	5	168,11
107720051	50	50	F05	3	182,80
107725051	65	61	F07	1/2	277,57
107730051	80	74	F07	1	331,58
107740051	100	95	F07	1	401,02
107750011	125	120	F10	1	768,74
107760011	150	145	F10	1	1.007,69
107780001	200	200	F10	1	2.284,35



### IVR 77 + IVR 180



IVR 77 - Valvola flangiata in ghisa GJL 250 - attacchi flangiati PN 16 + IVR 180 - Riduttore di manovra manuale  
IVR 77 - Cast iron GJL 250 ball valve - flanged ends PN 16 + IVR 180 - Manual gearbox  
IVR 77 - Flanschugelhahn aus Gusseisen GJL 250 - Flanschanschlüsse PN 16 + IVR 180 - Manuelles Getriebe  
IVR 77 - Vanne bride en fonte GJL 250 - fixations bridées PN 16 + IVR 180 - Réducteur de manoeuvre manuelle  
IVR 77 - Шаровой кран из чугуна GJL 250 - Фланцевое соединение PN 16 + IVR 180 - Ручной редуктор

Cod./Code	DN	Ø	ISO	□/田	€
407715070	40	40	F04	1	369,08
407720070	50	50	F05	1	376,71
407725070	65	61	F07	1	472,13
407730070	80	74	F07	1	527,87
407740070	100	95	F07	1	599,59
407750070	125	120	F10	1	1.018,81
407760070	150	145	F10	1	1.248,41



### IVR 78



Valvola a sfera in ghisa GJL 250 - asta e sfera inox - attacchi flangiati PN 16  
Cast iron GJL 250 ball valve - Inox stem and ball - Flanged ends PN 16 - Mounting flange ISO 5211  
Kugelhahn aus Gusseisen GJL 250 - Spindel und Kugel aus Edelstahl - Flanschanschlüsse PN 16  
Vanne à boisseau sphérique en fonte GJL 250 - tige et sphère inox - fixations bridées PN 16  
Шаровой кран из чугуна GJL 250 - Шток и шар из нержавеющей стали - Фланцевое соединение PN 16

Cod./Code	DN	Ø	ISO	□/田	€
107807051	20	20	F04	10	121,47
107810051	25	25	F04	8	165,39
107812051	32	32	F04	5	177,16
107815051	40	40	F05	5	210,57
107820051	50	50	F05	3	237,94
107825051	65	61	F07	1/2	330,26
107830051	80	74	F07	1/2	411,61
107840051	100	95	F07	1	513,83
107850011	125	120	F10	1	955,98
107860011	150	145	F10	1	1.413,05



## IVR 78 + IVR 180



IVR 78 Valvola flangiata in ghisa GJL 250 - asta e sfera inox - attacco PN 16 + IVR 180 Riduttore di manovra man.

IVR 78 - Cast iron GJL 250 ball valve - stainless steel stem and ball - flanged ends PN 16 + IVR 180 - Manual gearbox

IVR 78 Flansch-Kugelhahn aus Gusseisen GJL 250 - Spindel und Kugel aus Edelstahl - Anschluss + IVR 180 Manuelles Getriebe

IVR 78 Vanne bride en fonte GJL 250 - tige et sphère inox - fixation PN 16 + IVR 180 Réducteur de manœuvre manuelle

IVR 78 Шаровой кран из чугуна GJL 250 - Шток и шар из нержавеющей стали - Фланцевое соединение PN 16 + IVR 180 - Ручной редуктор

Cod./Code	DN	Ø	□/田	€
407815070	40	40	1	414,80
407820070	50	50	1	433,60
407825070	65	61	1	526,50
407830070	80	74	1	610,43
407840070	100	95	1	716,00
407850070	125	120	1	1.212,01
407860070	150	145	1	1.683,64



## IVR 80



Valvola a sfera a corpo piatto in ghisa GJL 250 - attacchi flangiati PN16

Cast iron GJL 250 ball valve - Flanged ends PN16

Kugelhahn mit Flachkörper aus Gusseisen GJL 250 - Flanschanschlüsse PN16

Vanne à boisseau sphérique à corps plat en fonte GJL 250 - fixations bridées PN16

Шаровой кран с укороченным корпусом из чугуна GJL 250 - Фланцевое соединение PN 16

Cod./Code	DN	Ø	□/田	€
108012001	32	32	8	137,06
108015001	40	40	6	147,34
108020001	50	50	5	165,93
108025001	65	61	1/3	215,50
108030001	80	74	1/2	285,65
108040001	100	95	1/2	337,06



## IVR 81



Valvola a sfera a corpo piatto in ghisa GJL 250 - attacchi flangiati PN16 - sfera inox

Cast iron GJL 250 ball valve - Flanged ends PN16 - Inox ball

Kugelhahn mit Flachkörper aus Gusseisen GJL 250 - Flanschanschlüsse PN16 - Edelstahlkugel

Vanne à boisseau sphérique à corps plat en fonte GJL 250 - fixations bridées PN16 - sphère inox

Шаровой кран с укороченным корпусом из чугуна GJL 250 - Фланцевое соединение PN 16 - шар из нержавеющей стали

Cod./Code	DN	Ø	□/田	€
108112001	32	32	8	140,50
108115001	40	40	6	152,01
108120001	50	50	5	178,01
108125001	65	61	1/3	234,51
108130001	80	74	1/2	326,41
108140001	100	95	1/2	406,81



## IVR 175



Valvola a farfalla in ghisa tipo LUG - attacchi flangiati PN16  
Cast iron butterfly valve LUG type - Flanged ends PN16  
Ventil mit Flügelgriff aus Gusseisen Typ LUG - Flanschanschlüsse PN16  
Vanne papillon en fonte type LUG - fixations bridées PN 16  
Дисковый затвор Баттерфляй из чугуна - тип LUG - Фланцевое соединение PN 16

Cod./Code	DN	Ø	ISO	□/田	€
117515001N	40	40	F05	8	67,01
117520001N	50	50	F05	4	70,85
117525001N	65	65	F05	1/3	79,44
117530001N	80	80	F05	1/2	89,54
117540001N	100	100	F07	1/2	135,44
117550001N	125	125	F07	1	175,07
117560001N	150	150	F07	1	207,54
117580001N	200	200	F10	1	357,18
417590001N	250	250	F10	1	709,51
417595001N	300	300	F10	1	939,91



## IVR 275 CF8M



Valvola a farfalla in ghisa tipo LUG - attacchi flangiati PN16 - Disco Inox CF8M  
LUG-type cast iron butterfly valve - PN16 flanged connections - Stainless steel disc  
LUG Absperrklappe aus Gusseisen - PN16-Flanschverbindungen - Edelstahlscheibe  
Vanne papillon fonte LUG - Raccords à brides PN16 - Disque inox  
Дроссельная заслонка из чугуна, тип LUG - фланцевые соединения PN16 - диск из нержавеющей стали

Cod./Code	DN	Ø	ISO	□/田	€
127515001N	40	40	F05	8	84,88
127520001N	50	50	F05	4	84,88
127525001N	65	65	F05	1/3	101,60
127530001N	80	80	F05	1/2	126,04
127540001N	100	100	F07	1/2	187,83
127550001N	125	125	F07	1	250,74
127560001N	150	150	F07	1	320,18
127580001N	200	200	F10	1	543,93
427590001N	250	250	F10	1	1.104,28
427595001N	300	300	F10	1	1.502,54



## IVR 176



Valvola a farfalla in ghisa tipo WAFER - attacchi flangiati PN16  
Cast iron butterfly valve WAFER type - Flanged ends PN16  
Ventil mit Flügelgriff aus Gusseisen Typ WAFER - Flanschanschlüsse PN16  
Vanne papillon en fonte type WAFER - fixations bridées PN16  
Дисковый затвор Баттерфляй из чугуна - тип WAFER - Фланцевое соединение PN 16

Cod./Code	DN	Ø	ISO	□/田	€
117615001N	40	40	F05	8	52,36
117620001N	50	50	F05	6	55,44
117625001N	65	65	F05	1/4	66,23
117630001N	80	80	F05	1/4	71,80
117640001N	100	100	F07	1/2	96,76
117650001N	125	125	F07	1	130,26
117660001N	150	150	F07	1	151,48
117680001N	200	200	F10	1	243,80
417690001N	250	250	F10	1	436,29
417695001N	300	300	F10	1	573,12



## IVR 276 CF8M



Valvola a farfalla in ghisa tipo WAFER - attacchi flangiati PN16 - Disco Inox CF8M

Cast iron butterfly valve WAFER type - flanged ends PN16 - stainless steel CF8M disc

Ventil mit Flügelgriff aus Gusseisen Typ WAFER - Flanschanschlüsse PN16 - mit Scheibe aus rostfreiem Stahl CF8M

Vanne papillon en fonte type WAFER - fixations bridées PN16 - disque en acier inoxydable CF8M

Дисковый затвор Баттерфляй из чугуна - тип WAFER - фланцевое соединение PN 16 - диск из нержавеющей стали CF8M

Cod./Code	DN	Ø	□/田	€
127612001N	32	32	1	72,93
127615001N	40	40	8	75,09
127620001N	50	50	4	79,41
127625001N	65	65	1/3	96,19
127630001N	80	80	1/2	110,37
127640001N	100	100	1/2	165,03
127650001N	125	125	1	229,78
127660001N	150	150	1	292,36
127680001N	200	200	1	482,09
427690001N	250	250	1	801,76
427695001N	300	300	1	1.112,58



## IVR 174



Valvola di ritegno a doppio battente interflangia, in ghisa, tipo WAFER

Cast iron dual plate check valve, WAFER type

Rückschlagventil mit doppelter Scheibenklappe, aus Gusseisen, Typ WAFER

Vanne de retenue à double battant entre-bridge, en fonte, type WAFER

Двухстворчатый межфланцевый обратный клапан из чугуна - тип WAFER

Cod./Code	DN	□/田	€
117420001N	50	10	57,05
117425001N	65	1/10	72,90
117430001N	80	1/5	88,48
117440001N	100	1/5	108,07
117450001N	125	1/2	143,07
117460001N	150	1/2	194,46
117480001N	200	1	330,25
117490001N	250	1	454,88
117495001N	300	1	729,58



## IVR 282



Valvola di ritegno a doppio battente in acciaio INOX wafer - PN16

Valvola di ritegno a doppio battente in acciaio INOX wafer - PN16

Doppelschwenk-Rückschlagventil in Edelstahlwafer - PN16

Vanne de retenue à double battant en acier INOX wafer - PN16

Двухстворчатый обратный клапан из нержавеющей стали типа wafer - PN16

Cod./Code	DN	Ø	□/田	€
128220030	50	50	10	64,28
128225030	65	63	1/10	73,54
128230030	80	69	1/5	104,66
128240030	100	97	1/5	149,09
128250030	125	121	1/2	187,32
128260030	150	145	1/2	278,35
128280030	200	197	1	479,48
128290030	250	234	1	784,75
128295030	300	284	1	1.124,41





## IVR 279

NEW



Valvole di intercettazione a saracinesca corpo piatto a cuneo gommato - attacchi flangiati PN10-16

Flat body, soft seated gate shut-off valves - flanged couplings PN10-16

Flaches Absperschieber mit gummierten Keilflanschanschlüssen PN10-16

Vanne d'arrêt à opercule corps plat caoutchouc - raccords à brides PN10-16

Запорные клапаны с задвижками с прорезиненным клиновидным корпусом - фланцевые соединения PN10-16

Cod./Code	DN	Ø	□/田	€
127915030	40	40	1	150,87
127920030	50	50	1	150,87
127925030	65	65	1	174,76
127930030	80	80	1	198,61
127940030	100	100	1	222,49
127950030	125	125	1	373,46
127960030	150	150	1	421,14
127980030	200	200	1	667,47
127990030	250	250	1	1.175,91
127995030	300	300	1	1.493,80
127996030	350	350	1	3.006,61
127997030	400	400	1	4.371,87



## IVR 281

NEW



Valvola di intercettazione a flusso avviato a baderna - attacchi flangiati PN 16

Swivel globe shut-off valve - flanged couplings PN 16

Durchflussabsperventil - PN 16-Flanschanschlüsse

Vanne d'arrêt contrôle de flux - raccords à brides PN 16

Запорный клапан пусковой - фланцевые соединения PN 16

Cod./Code	DN	Ø	□/田	€
128105030	15	15	1	66,23
128107030	20	20	1	76,93
128110030	25	25	1	91,28
128112030	32	32	1	108,62
128115030	40	40	1	145,52
128120030	50	50	1	170,45
128125030	65	65	1	224,79
128130030	80	80	1	363,55
128140030	100	100	1	472,28
128150030	125	125	1	703,51
128160030	150	150	1	987,98
128180030	200	200	1	1.661,19
128190030	250	250	1	2.956,44



## IVR 288

NEW



Valvola di intercettazione a flusso avviato a soffietto - flangiata PN 16

Bellows globe shut-off valve - flanged PN 16

Durchflussabsperventil mit Faltenbalg - angeflanscht PN 16

Vanne d'arrêt contrôle de flux démarré à soufflet - bride PN 16

Запорный клапан сифонный - фланцевый PN 16

Cod./Code	DN	Ø	□/田	€
128805030	15	15	1	230,37
128807030	20	20	1	244,86
128810030	25	25	1	284,95
128812030	32	32	1	326,18
128815030	40	40	1	420,71
128820030	50	50	1	486,22
128825030	65	65	1	699,55
128830030	80	80	1	814,70
128840030	100	100	1	1.274,36
128850030	125	125	1	1.656,28
128860030	150	150	1	2.281,88
128880030	200	200	1	4.357,63



## IVR 283

NEW



Valvola di ritegno a molla - flangiata PN 10/16  
Spring check valve - flanged PN 10/16  
Federrückschlagventil - angeflanscht PN 10/16  
Vanne de retenue à ressort - bride PN 10/16  
Обратный клапан пружинно-фланцевый PN 10/16

Cod./Code	DN	Ø	□/田	€
128320030	50	50	1	110,58
128325030	65	65	1	122,19
128330030	80	80	1	145,28
128340030	100	100	1	184,02
128350030	125	125	1	287,53
128360030	150	150	1	368,63
128380030	200	200	1	631,88
128390030	250	250	1	916,25
128395030	300	300	1	1.484,91



## IVR 284

NEW



Valvola di ritegno a palla - flangiata PN 16  
Spring check valve - flanged PN 16  
Federrückschlagventil - angeflanscht PN 16  
Vanne de retenue à ressort - bride PN 16  
Обратный клапан пружинно-фланцевый PN 16

Cod./Code	DN	Ø	□/田	€
128415030	40	40	1	166,40
128420030	50	50	1	166,40
128425030	65	65	1	169,16
128430030	80	80	1	275,91
128440030	100	100	1	364,42
128450030	125	125	1	537,11
128460030	150	150	1	699,31
128480030	200	200	1	1.381,69
128490030	250	250	1	2.538,02
128495030	300	300	1	3.538,62



## IVR 285

NEW



Valvola di ritegno a palla - filettata F/F  
Ball check valve - threaded F/F  
Kugelrückschlagventil - Gewinde F/F  
Vanne de retenue à bille - Fixation F/F  
Обратный клапан шаровой с резьбой F/F

Cod./Code	Mis./Size	Ø	□/田	€
128510030	1"	25	1	98,92
128512030	1"1/4	32	1	102,70
128515030	1"1/2	40	1	120,41
128520030	2"	50	1	143,22
128525030	2"1/2	65	1	192,67
128530030	3"	80	1	231,13



## IVR 286

NEW



Valvola di ritegno a flusso avviato - flangiata PN 16

Globe check valve - flanged PN 16

Anlauf-Rückschlagventil - angeflanscht PN 16

Vanne de retenue contrôle de flux - bride PN 16

Обратный клапан пусковой фланцевый PN 16

Cod./Code	DN	Ø	□/田	€
128605030	15	15	1	59,59
128607030	20	20	1	69,39
128610030	25	25	1	82,04
128612030	32	32	1	97,77
128615030	40	40	1	130,93
128620030	50	50	1	153,44
128625030	65	65	1	202,28
128630030	80	80	1	327,38
128640030	100	100	1	425,06
128650030	125	125	1	633,22
128660030	150	150	1	889,25
128680030	200	200	1	1.494,99
128690030	250	250	1	2.660,79

## IVR 170



Valvola di ritegno a clapet - in ghisa GJS 500 - attacchi flangiati PN 16

Swing check valve - Cast iron GJS 500 - flanged ends PN 16

Rückschlagventil bzw. Klappen- aus Gusseisen GJS 500 - Flanschanschlüsse PN 16

Vanne de retenue à clapet - en fonte GJS 500 - fixations bridées PN 16

Обратный клапан clapet из чугуна GJS 500 - Фланцевое соединение PN 16

Cod./Code	DN	Ø	□/田	€
117020020	50	50	2	129,64
117025020	65	65	1	149,04
117030020	80	80	1	181,10
117040020	100	100	1	244,51
117050020	125	125	1	332,94
117060020	150	150	1	412,94
117080020	200	200	1	602,98
117090020	250	250	1	1.097,63
117095020	300	300	1	1.485,96



## IVR 172



Filtro a Y con spurgo - in ghisa GJS 500 - attacchi flangiati PN 16

Y strainer with drain - Cast iron GJS 500 - flanged ends PN 16

Y- förmiger Filter mit Ablauf (Entleerung)- aus Gusseisen GJS 500 - Flanschanschlüsse PN 16

Filtre en Y avec purge - en fonte GJS 500 - fixations bridées PN 16

Фильтр осадочный Y-образный с дренажным отверстием - Чугун GJS 500 - Фланцевое соединение PN 16

Cod./Code	DN	Ø	□/田	€
117212020N	32	32	1	62,40
117215020N	40	40	1	73,06
117220020N	50	50	2	93,64
117225020N	65	65	1	129,55
117230020N	80	80	1	168,26
117240020N	100	100	1	231,79
117250020N	125	125	1	331,15
117260020N	150	150	1	489,84
117280020N	200	200	1	799,80
117290020N	250	250	1	1.784,66
117295020N	300	300	1	2.184,58



## GIUNTI ANTIVIBRANTI ANTI-VIBRATION JOINT

### IVR 287

NEW



Giunto in gomma piena EPDM - PN 10/16  
Solid rubber joint EPDM - PN 10/16  
Vollgummiverbindung EPDM - PN 10/16  
Joint en caoutchouc plein EPDM - PN 10/16  
Резиновый уплотнитель EPDM-PN 10/16

Cod./Code	DN	Ø	□/田	€
128712030	32	32	1	105,47
128715030	40	40	6	112,63
128720030	50	50	1	136,29
128725030	65	65	1	157,65
128730030	80	80	1	177,77
128740030	100	100	1	237,08
128750030	125	125	1	290,40
128760030	150	150	1	361,55



### IVR 697



Giunto antivibrante flangiato - PN16  
Flanged rubber flexible joint - PN16  
Schwingungsgedämpfter Flanschanschluss - PN16  
Joint antivibration bridé - PN16  
Фланцевая антивибрационная вставка - PN16

Cod./Code	DN	□/田	€
169712001N	32	8	45,16
169715001N	40	8	49,69
169720001N	50	4	54,51
169725001N	65	1/2	74,45
169730001N	80	1/2	91,37
169740001N	100	1/2	111,26
169750001N	125	1	151,89
169760001N	150	1	200,60
169780001N	200	1	321,71
169790001N	250	1	486,52
169795001N	300	1	580,88



### IVR 696



Giunto antivibrante filettato - PN16  
Threaded rubber flexible vibration-free joint - PN16  
Schwingungsgedämpfter Gewindeanschluss - PN16  
Joint antivibration fileté - PN16  
Резьбовая антивибрационная вставка - PN16

Cod./Code	Mis./Size	□/田	€
169607001N	3/4"	1/12	26,77
169610001N	1"	1/12	29,29
169612001N	1"1/4	1/12	33,72
169615001N	1"1/2	1/4	42,63
169620001N	2"	1/4	52,36
169625001N	2"1/2	1/4	69,26
169630001N	3"	1/4	97,64



## ACCESSORI VALVOLE INDUSTRIALI ACCESSORIES FOR INDUSTRIAL VALVES

### IVR 180



Riduttore di manovra manuale per valvola a sfera flangiata per IVR 77 - 78 - 82 - 83

Gearbox for cast iron flanged ball valve for IVR 77 - 78 - 82 - 83

Handgetriebe für Flansch-Kugelhahn für IVR 77 - 78 - 82 - 83

Réducteur de manoeuvre manuelle pour vanne à boisseau sphérique bride en fonte/Inox IVR 77 - 78 - 82 - 83

Редуктор для фланцевых кранов IVR 77 - 78 - 82 - 83

Cod./Code	Mod./Model	□/田	€
118020010	da DN 40 a 50	1/4	139,90
118030010	da DN 65 a 100	1/4	139,90
118050010	da DN 125 a 150	1	196,58



### IVR 97/G



Prolunga di manovra per isolamento termico (per IVR 77-78)

Stem extension for thermal insulation (for IVR 77-78)

Verlängerung für Wärmeisolierung (für IVR 77-78)

Rallonge pour isolation thermique (pour IVR 77-78)

Насадка удлиняющая для установки теплоизоляции (для IVR 77-78)

Cod./Code	Mod./Model	□/田	€
109710100	2 MIS	5/60	34,01
109715100	3 MIS	4/48	102,29
109725100	5 MIS	2/12	195,82
109740100	6 MIS	2/8	137,01



### IVR 97/F



Prolunga di manovra per isolamento termico (per IVR 80-81)

Stem extension for thermal insulation (for IVR 80-81)

Verlängerung für Wärmeisolierung (für IVR 80-81)

Rallonge pour isolation thermique (pour IVR 80-81)

Насадка удлиняющая для установки теплоизоляции (для IVR 80-81)

Cod./Code	Mod./Model	□/田	€
109715001	3 MIS	9/54	10,98
109720001	4a MIS	5/30	20,52
109725001	5 MIS	4/16	59,35



### IVR 179



Riduttore di manovra per valvole a farfalla tipo LUG-WAFER

Gearbox for butterfly valves LUG-WAFER

Getriebe für Ventile mit Flügelgriff Typ LUG-WAFER

Réducteur de manoeuvre pour vannes papillon type LUG-WAFER

Редуктор управления для дисковых затворов Баттерфляй тип LUG - WAFER

Cod./Code	Mod./Model	□/田	€
117930010N	da DN 40 a 80	1/4	64,08
117940010N	per DN 100	1/4	64,08
117960010	da DN 125 a 150	1/4	64,08
117960010N	da DN 125 a 150	1/4	64,08
117980010N	per DN 200	1	121,77
117990010N	per DN 250	1	121,77
117995010N	per DN 300	1	147,42



## VALVOLE INDUSTRIALI CON ATTUATORI ELETTRICI INDUSTRIAL VALVES WITH ELECTRIC ACTUATORS

### IVR 77 + IVR 272 M



IVR 77 - Valvola flangiata in ghisa GJL 250 - attacchi flangiati PN16 + IVR 272 - attuatore elettrico multitemperatura a 1/4 di giro - da 24 Vac/dc a 240 Vac/dc

IVR 77 - Flanged valve in cast iron GJL 250 - flanged connections PN16 + IVR 272 - 1/4 turn multivoltage electric actuator - from 24 Vac / dc to 240 Vac / dc

IVR 77 - Flanschventil aus Gusseisen GJL 250 - Flanschanschlüsse PN16 + IVR 272 - 1/4 des elektrischen Mehrspannungsantriebs Umdrehung - von 24 VAC / DC bis 240 VAC / DC

IVR 77 - Vanne à brides en fonte GJL 250 - raccords à brides PN16 + IVR 272-1 / 4 de servomoteur électrique multitemperatura révolution - de 24 Vac / dc à 240 Vac / dc

IVR 77 - Фланцевый клапан из чугуна GJL 250 - фланцевые соединения PN16 + IVR 272 - 1/4 мультитензионный электропривод на 1/4 оборота - от 24 В пер. / пост. тока до 240 В пер. / пост.тока оборот - от 24 Vac / dc до 240 Vac / dc

Cod./Code	Mod./Model	DN	□/⊞	€
407707412	IVR 77 DN 20 + S20	20	1	853,76
407710412	IVR 77 DN 25 + S20	25	1	874,51
407712428	IVR 77 DN 32 + S35	32	1	1.032,48
407715428	IVR 77 DN 40 + S35	40	1	973,12
407720467	IVR 77 DN 50 + S55	50	1	1.341,23
407725467	IVR 77 DN 65 + S55	65	1	1.885,84
407730509	IVR 77 DN 80 + S140	80	1	2.091,05
407740509	IVR 77 DN100 + S140	100	1	2.140,53
407750528	IVR 77 DN125 + S140	125	1	2.905,75
407760528	IVR 77 DN150 + S300	150	1	3.154,06



### IVR 78 + IVR 272 M



IVR 78 - Valvola flangiata in ghisa GJL 250 - asta e sfera inox - attacchi flangiati PN16 + IVR 272 - attuatore elettrico multitemperatura a 1/4 di giro - da 24 Vac/dc a 240 Vac/dc

IVR 78 - Flanged valve in cast iron GJL 250 - stainless steel rod and ball - flanged connections PN16 + IVR 272 - 1/4 turn multivoltage electric actuator - from 24 Vac / dc to 240 Vac / dc

IVR 78 - Flanschventil aus Gusseisen GJL 250 - Edelstahlstange und Kugelflanschanschlüsse PN16 + IVR 272 - Mehrspannungs-Elektroantrieb mit 1/4 Umdrehung - von 24 VAC / DC bis 240 VAC / DC

IVR 78 - Vanne à brides en fonte GJL 250 - tige et bille en acier inoxydable - raccords à brides PN16 + IVR 272 - Servomoteur électrique multitemperatura 1/4 de tour - de 24 Vac / dc à 240 Vac / dc

IVR 78 - фланцевый клапан из чугуна GJL 250 - шток и шар из нержавеющей стали - фланцевые соединения PN16 + IVR 272 - мультитензионный электропривод на 1/4 оборота - от 24 Vac / dc до 240 Vac / dc

Cod./Code	Mod./Model	DN	□/⊞	€
407807412	IVR 78 DN 20 + S20	20	1	849,81
407810412	IVR 78 DN 25 + S20	25	1	895,94
407812428	IVR 78 DN 32 + S35	32	1	1.055,83
407815428	IVR 78 DN 40 + S35	40	1	1.018,82
407820467	IVR 78 DN 50 + S55	50	1	1.396,05
407825467	IVR 78 DN 65 + S55	65	1	1.929,35
407830509	IVR 78 DN 80 + S140	80	1	2.162,39
407840509	IVR 78 DN100 + S140	100	1	2.258,41
407850528	IVR 78 DN125 + S140	125	1	3.092,58
407860528	IVR 78 DN150 + S300	150	1	3.563,08





## IVR 175 + IVR 272 M



IVR 175 - Valvola a farfalla in ghisa tipo LUG - attacchi flangiati PN16 + IVR 272 - attuatore elettrico multitemperatura a 1/4 di giro - da 24 V ac/dc a 240 V ac/dc

IVR 175 - Cast iron butterfly valve type LUG - flanged connections PN16 + IVR 272 - multivoltage 1/4 turn electric actuator - from 24 V ac/dc to 240 V ac/dc

IVR 175 - Gusseisen-Absperrklappe Typ LUG - Flanschanschlüsse PN16 + IVR 272 - Mehrspannungs-Stellantrieb mit 1/4 Umdrehung - von 24 V ac/dc bis 240 V ac/dc

IVR 175 - Vanne papillon en fonte type LUG - raccords à brides PN16 + IVR 272 - servomoteur électrique multitemperatura 1/4 de tour - de 24 V ac/dc à 240 V ac/dc

IVR 175 - дроссельная заслонка из чугуна типа LUG - фланцевые соединения PN16 + IVR 272 - многовольтный 1/4 оборотный электропривод - от 24 V ac/dc до 240 V ac/dc

Cod./Code	Mod./Model	DN	□/田	€
417515428	IVR175 DN 40 + S20	40	1	900,02
417520428	IVR175 DN 50 + S20	50	1	903,10
417525428	IVR175 DN 65 + S35	65	1	910,01
417530428	IVR175 DN 80 + S35	80	1	998,75
417540467	IVR175 DN100 + S85	100	1	1.557,68
417550509	IVR175 DN125 + S140	125	1	2.356,57
417560509	IVR175 DN150 + S140	150	1	2.383,31



## IVR 176 + IVR 272 M



IVR 176 - Valvola a farfalla in ghisa tipo WAFER - attacchi flangiati PN16 + IVR 272 - attuatore elettrico multitemperatura a 1/4 di giro - da 24 V ac/dc a 240 V ac/dc

IVR 176 - WAFER type cast iron butterfly valve - flanged connections PN16 + IVR 272 - 1/4 turn multivoltage electric actuator - from 24 V ac/dc to 240 V ac/dc

IVR 176 - Absperrklappe aus Gusseisen vom Typ WAFER - Flanschanschlüsse PN16 + IVR 272 - Mehrspannungs-Elektroantrieb mit 1/4 Umdrehung - von 24 V ac/dc bis 240 V ac/dc

IVR 176 - Vanne papillon en fonte type WAFER - raccords à brides PN16 + IVR 272 - Servomoteur électrique multitemperatura 1/4 de tour - de 24 V ac/dc à 240 V ac/dc

IVR 176 - дроссельная заслонка из чугуна WAFER - фланцевые соединения PN16 + IVR 272 - многовольтный электропривод на 1/4 оборота - от 24 V ac/dc до 240 V ac/dc

Cod./Code	Mod./Model	DN	□/田	€
417615428	IVR176 DN 40 + S20	40	1	892,57
417620428	IVR176 DN 50 + S20	50	1	895,22
417625428	IVR176 DN 65 + S35	65	1	904,75
417630428	IVR176 DN 80 + S35	80	1	990,32
417640467	IVR176 DN100 + S85	100	1	1.534,12
417650509	IVR176 DN125 + S140	125	1	2.330,77
417660509	IVR176 DN150 + S140	150	1	2.350,06
417680528	IVR176 DN200 + S300	200	1	2.462,81
417690547	IVR176 DN250 + PSQ 503 230v 93s	250	1	3.139,98
417695567	IVR176 DN300 + PSQ 703 230v 93s	300	1	3.461,85



## IVR 276 CF8M + IVR 272 M



IVR 276 CF8M - Valvola a farfalla in ghisa tipo WAFER - disco inox - attacchi flangiati PN16 + IVR 272 - attuatore elettrico multitemperatura a 1/4 di giro - da 24 V ac/dc a 240 V ac/dc

IVR 276 CF8M - WAFER type cast iron butterfly valve - stainless steel disc - flanged connections PN16 + IVR 272 - 1/4 turn multivoltage electric actuator - from 24 V ac/dc to 240 V ac/dc

IVR 276 CF8M - Absperrklappe aus Gusseisen vom Typ WAFER - Edelstahl-scheibe - Flanschanschlüsse PN16 + IVR 272 - Mehrspannungs-Elektroantrieb mit 1/4 Umdrehung - von 24 V ac/dc bis 240 V ac/dc

IVR 276 CF8M - Vanne papillon fonte type WAFER - Disque inox - Raccords à brides PN16 + IVR 272 - Servomoteur électrique multitemperatura 1/4 de tour - de 24 V ac/dc à 240 V ac/dc

IVR 276 CF8M - дроссельная заслонка из чугуна WAFER - диск из нержавеющей стали - фланцевые соединения PN16 + IVR 272 - многовольтный электропривод на 1/4 оборота - от 24 V ac/dc до 240 V ac/dc

Cod./Code	Mod./Model	DN	□/田	€
427615428	IVR276 DN 40 +S20	40	1	912,57
427620428	IVR276 DN 50 + S20	50	1	916,40
427625428	IVR276 DN 65 +S35	65	1	931,24
427630428	IVR276 DN 80 + S35	80	1	1.024,39
427640467	IVR276 DN100 + S85	100	1	1.595,38
427650509	IVR276 DN125 + S140	125	1	2.420,08
427660509	IVR276 DN150 + S140	150	1	2.476,50
427680528	IVR276 DN200 + S300	200	1	2.673,15
427690547	IVR276 DN250 + PSQ 503 230v 93s	250	1	3.564,82
427695567	IVR276 DN300 + PSQ 703 230v 93s	300	1	4.133,92



## IVR 662 + IVR 272 M



IVR 662 - Valvola a in acciaio inox - attacchi F/F- flangia ISO 5211 + IVR 272 - attuatore elettrico multitemperatura a 1/4 di giro - da 24 V ac/dc a 240 V ac/dc

IVR 662 - Stainless steel valve a - F / F connections - ISO 5211 flange + IVR 272 - 1/4 turn multivoltage electric actuator - from 24 V ac/dc to 240 V ac/dc

IVR 662 - Edelstahlventil - F / F-Anschlüsse - Flansch ISO 5211 + IVR 272 - Mehrspannungs-Elektroantrieb mit 1/4 Umdrehung - von 24 V ac/dc bis 240 V ac/dc

IVR 662 - Vanne en acier inoxydable A - Raccords F / F - Bride ISO 5211 + IVR 272 - Servomoteur électrique multitemperatura 1/4 de tour - de 24 V ac/dc à 240 V ac/dc

IVR 662 - Клапан из нержавеющей стали a - Соединения F / F - фланец ISO 5211 + IVR 272 - Электропривод мультитензионный на 1/4 оборота - от 24 V ac/dc до 240 V ac/dc

Cod./Code	Mod./Model	Mis./Size	□/田	€
466202412	IVR 662 1/4" + S20	1/4"	1	766,82
466203412	IVR 662 3/8" + S20	3/8"	1	766,82
466205412	IVR 662 1/2" + S20	1/2"	1	766,82
466207412	IVR 662 3/4" + S20	3/4"	1	772,49
466210412	IVR 662 1" + S20	1"	1	785,25
466212412	IVR 662 1 1/4" + S35	1 1/4"	1	802,81
466215428	IVR 662 1 1/2" + S35	1 1/2"	1	908,52
466220428	IVR 662 2" + S35	2"	1	943,16
466225488	IVR 662 2 1/2" + S85	2 1/2"	1	1.840,08
466230509	IVR 662 3" + S140	3"	1	2.063,33
466240509	IVR 662 4" + S140	4"	1	2.301,89



## IVR 665 + IVR 272 M



IVR 665 - Valvola a sfera in tre pezzi in acciaio inox - attacchi F/F- flangia ISO 5211 + IVR 272 - attuatore elettrico multitemperatura a 1/4 di giro - da 24 V ac/dc a 240 V ac/dc

IVR 665 - Stainless steel three-piece ball valve - F / F connections - ISO 5211 flange + IVR 272 - 1/4 turn multivoltage electric actuator - from 24 V ac/dc to 240 V ac/dc

IVR 665 - Dreiteiliger Kugelhahn aus rostfreiem Stahl - F / F-Anschlüsse - Flansch ISO 5211 + IVR 272 - Mehrspannungs-Elektroantrieb mit 1/4 Umdrehung - von 24 V ac/dc bis 240 V ac/dc

IVR 665 - Vanne à boisseau sphérique trois pièces en acier inoxydable - Raccords F / F - Bride ISO 5211 + IVR 272 - Servomoteur électrique multitemperatura 1/4 de tour - de 24 V ac/dc à 240 V ac/dc

IVR 665 - Трехкомпонентный шаровой кран из нержавеющей стали - Соединения F / F - Фланец ISO 5211 + IVR 272 - Электропривод мультитензионный на 1/4 оборота - от 24 V ac/dc до 240 V ac/dc

Cod./Code	Mod./Model	Mis./Size	□/田	€
466502412	IVR 665 1/4" + S20	1/4"	1	782,61
466503412	IVR 665 3/8" + S20	3/8"	1	782,61
466505412	IVR 665 1/2" + S20	1/2"	1	785,06
466507412	IVR 665 3/4" + S20	3/4"	1	799,38
466510412	IVR 665 1" + S20	1"	1	810,91
466512412	IVR 665 1 1/4" + S35	1 1/4"	1	836,74
466515428	IVR 665 1 1/2" + S35	1 1/2"	1	944,59
466520428	IVR 665 2" + S35	2"	1	978,21
466525488	IVR 665 2 1/2" + S85	2 1/2"	1	1.935,75
466530509	IVR 665 3" + S140	3"	1	2.228,17
466540509	IVR 665 4" + S140	4"	1	2.460,70



## IVR 663 + IVR 272 M



IVR 663 - Valvola a sfera in tre pezzi in acciaio inox - attacchi F/F- flangia ISO 5211 + IVR 272 - attuatore elettrico multitemperatura a 1/4 di giro - da 24 V ac/dc a 240 V ac/dc

IVR 663 - Stainless steel three-piece ball valve - F / F connections - ISO 5211 flange + IVR 272 - 1/4 turn multivoltage electric actuator - from 24 V ac/dc to 240 V ac/dc

IVR 663 - Dreiteiliger Kugelhahn aus Edelstahl - F / F-Anschlüsse - Flansch ISO 5211 + IVR 272 - Mehrspannungs-Mehrspannungs-Stellantrieb mit 1/4 Umdrehung - von 24 V ac/dc bis 240 V ac/dc

IVR 663 - Vanne à boisseau sphérique trois pièces en acier inoxydable - Raccords F / F - Bride ISO 5211 + IVR 272 - Servomoteur électrique multitemperatura 1/4 de tour - de 24 V ac/dc à 240 V ac/dc

IVR 663 - Трехкомпонентный шаровой кран из нержавеющей стали - Соединения F / F - Фланец ISO 5211 + IVR 272 - Электропривод мультитензионный на 1/4 оборота - от 24 V ac/dc до 240 V ac/dc

Cod./Code	Mod./Model	Mis./Size	□/田	€
466305412	IVR 663 1/2" + S20	1/2"	1	781,70
466307412	IVR 663 3/4" + S20	3/4"	1	801,02
466310412	IVR 663 1" + S20	1"	1	819,44
466312412	IVR 663 1 1/4" + S35	1 1/4"	1	864,17
466315428	IVR 663 1 1/2" + S35	1 1/2"	1	989,61
466320428	IVR 663 2" + S35	2"	1	1.051,02
466325488	IVR 663 2 1/2" + S85	2 1/2"	1	1.996,20
466330509	IVR 663 3" + S140	3"	1	2.275,17
466340509	IVR 663 4" + S140	4"	1	2.590,07



## IVR 670 + IVR 272 M



IVR 670 - Valvola a sfera in tre pezzi in acciaio inox - attacchi a saldare - flangia ISO 5211 + IVR 272 - attuatore elettrico multitemensione a 1/4 di giro - da 24 Vac/dc a 240 Vac/dc

IVR 670 - Stainless steel three-piece ball valve - welding connections - ISO 5211 flange + IVR 272 - 1/4 turn multivoltage electric actuator - from 24 Vac / dc to 240 Vac / dc

IVR 670 - Dreiteiliger Kugelhahn aus Edelstahl - Schweißanschlüsse - Flansch ISO 5211 + IVR 272 - Mehrspannungs-Elektromotor mit 1/4 Umdrehung - von 24 VAC / DC bis 240 VAC / DC

IVR 670 - Vanne à boisseau sphérique trois pièces en acier inoxydable - raccords à souder - Bride ISO 5211 + IVR 272 - Servomoteur électrique multitemensione 1/4 de tour - de 24 Vac / dc à 240 Vac / dc

IVR 670 - трехкомпонентный шаровой кран из нержавеющей стали - сварные соединения - фланец ISO 5211 + IVR 272 - мультивольтный электропривод на 1/4 оборота - от 24 Vac / dc до 240 Vac / dc

Cod./Code	Mod./Model	Mis./Size	□/田	€
467002412	IVR670 1/4" +S20	1/4"	1	781,77
467003412	IVR670 3/8" + S20	3/8"	1	781,77
467005412	IVR670 1/2" +S20	1/2"	1	784,22
467007412	IVR670 3/4" + S20	3/4"	1	798,15
467010412	IVR670 1" + S20	1"	1	809,66
467012412	IVR670 1"1/4 + S35	1"1/4	1	834,67
467015428	IVR670 1"1/2 + S35	1"1/2	1	938,85
467020428	IVR670 2" + S35	2"	1	994,03
467025488	IVR670 2"1/2 + S85	2"1/2	1	1.967,04
467030509	IVR670 3" + S140	3"	1	2.262,22
467040509	IVR670 4" + S140	4"	1	2.493,43



## IVR 672 + IVR 272 M



IVR 672 - Valvola a sfera a passaggio totale in tre pezzi in acciaio inox AISI 316 - attacchi a saldare di tasca - flangia ISO 5211 + IVR 272 - attuatore elettrico multitemensione a 1/4 di giro - da 24 V ac/dc a 240 V ac/dc

IVR 672 - Three-piece full bore ball valve in AISI 316 stainless steel - socket weld connections - ISO 5211 flange + IVR 272 - 1/4 turn multivoltage electric actuator - from 24 V ac/dc to 240 V ac/dc

IVR 672 - Dreiteiliger Kugelhahn mit Vollbohrung aus Edelstahl AISI 316 - Muffenschweißverbindungen - Flansch ISO 5211 + IVR 272 - Mehrspannungs-Elektroantrieb mit 1/4 Umdrehung - von 24 V ac/dc bis 240 V ac/dc

IVR 672 - Vanne à boisseau sphérique à passage intégral trois pièces en acier inoxydable AISI 316 - raccords à souder à emboîtement - bride ISO 5211 + IVR 272 - servomoteur électrique multitemensione 1/4 de tour - de 24 V ac/dc à 240 V ac/dc

IVR 672 - трехкомпонентный полнопроходной шаровой кран из нержавеющей стали AISI 316 - соединения под приварку - фланец ISO 5211 + IVR 272 - мультивольтный электропривод на 1/4 оборота - от 24 В переменного / постоянного тока до 240 В переменного тока

Cod./Code	Mod./Model	Mis./Size	□/田	€
467202412	IVR672 1/4" + S20	1/4"	1	783,39
467203412	IVR672 3/8" + S20	3/8"	1	783,39
467205412	IVR672 1/2" + S20	1/2"	1	785,85
467207412	IVR672 3/4" + S20	3/4"	1	800,61
467210412	IVR672 1" + S20	1"	1	812,53
467212412	IVR672 1"1/4 + S35	1"1/4	1	839,19
467215428	IVR672 1"1/2 + S35	1"1/2	1	944,56
467220428	IVR672 2" + S35	2"	1	1.001,96
467225488	IVR672 2"1/2 +S85	2"1/2	1	1.983,35
467230509	IVR672 3" + S140	3"	1	2.285,66
467240509	IVR672 4" +S140	4"	1	2.529,80



## IVR 144 L + IVR 272 M



IVR 144L - Valvola a sfera a passaggio ridotto a tre vie in acciaio inox AISI 316 - sfera forata a L- attacchi F/F/F - flangia ISO 5211 + IVR 272 - attuatore elettrico multitemensione a 1/4 di giro - da 24 Vac/dc a 240 Vac/dc

IVR 144L - Three-way reduced bore ball valve in AISI 316 stainless steel - L-holed ball - F / F / F connections - ISO 5211 flange + IVR 272 - 1/4 turn multivoltage electric actuator - 24 Vac / dc to 240 Vac / dc

IVR 144L - Dreiwege-Kugelhahn mit reduzierter Bohrung aus Edelstahl AISI 316 - Kugel mit L-Loch - F / F / F-Anschlüsse - Flansch ISO 5211 + IVR 272 - Mehrspannungs-Elektroantrieb mit 1/4 Umdrehung - 24 VAC / DC bis 240 VAC / dc

IVR 144L - Vanne à boisseau sphérique trois voies à passage réduit en acier inoxydable AISI 316 - Bille en L - Raccords F / F / F - Bride ISO 5211 + IVR 272 - Servomoteur électrique multitemensione 1/4 de tour - 24 Vac / dc à 240 Vac / dc

IVR 144L - Трехходовой шаровой кран с редуцированным проходом из нержавеющей стали AISI 316 - L-образный проход шара - Соединения F / F / F - Фланец ISO 5211 + IVR 272 - Электропривод на 1/4 оборота - мультивольтный - от 24 В перем./пост. до 240 В перем./пост.

Cod./Code	Mod./Model	Mis./Size	□/田	€
414402412	IVR 144 1/4" + S20	1/4"	1	815,81
414403412	IVR 144 3/8" + S20	3/8"	1	815,81
414405412	IVR 144 1/2" + S20	1/2"	1	815,81
414407412	IVR 144 3/4" + S20	3/4"	1	833,83
414410412	IVR 144 1" + S20	1"	1	863,36
414412428	IVR 144 1"1/4 + S35	1"1/4	1	1.020,44
414415428	IVR 144 1"1/2 + S55	1"1/2	1	1.401,47
414420509	IVR 144 2" + S140	2"	1	2.165,82



## IVR 145 T + IVR 272 M



IVR 145T - Valvola a sfera a passaggio ridotto a tre vie in acciaio inox AISI 316 - sfera forata a T - attacchi F/F/F - flangia ISO 5211 + IVR 272 - attuatore elettrico multitemperatura a 1/4 di giro - da 24 Vac/dc a 240 Vac/dc

IVR 145T - Three-way reduced bore ball valve in AISI 316 stainless steel - T-shaped ball - F / F / F connections - ISO 5211 flange + IVR 272 - 1/4 turn multivoltage electric actuator - 24 Vac / dc to 240 Vac / dc

IVR 145T - Dreiwege-Kugelhahn mit reduzierter Bohrung aus Edelstahl AISI 316 - T-förmige Kugel - F / F / F-Anschlüsse - Flansch ISO 5211 + IVR 272 - Mehrspannungs-Elektroantrieb mit 1/4 Umdrehung - 24 VAC / DC bis 240 VAC / dc

IVR 145T - Vanne à boisseau sphérique trois voies à passage réduit en acier inoxydable AISI 316 - Bille en T - Raccords F / F / F - Bride ISO 5211 + IVR 272 - Servomoteur électrique multivoltage 1/4 de tour - 24 Vac / dc à 240 Vac / dc

IVR 145T - Трехходовой шаровой кран с уменьшенным проходным отверстием из нержавеющей стали AISI 316 - Т-образный шар - Соединения F / F / F - Фланец ISO 5211 + IVR 272 - многовольтный электропривод на 1/4 оборота - от 24 В перем./пост. до 240 В перем./пост.

Cod./Code	Mod./Model	Mis./Size	□/田	€
414502412	IVR 145 1/4" + S20	1/4"	1	815,81
414503412	IVR 145 3/8" + S20	3/8"	1	815,81
414505412	IVR 145 1/2" + S20	1/2"	1	815,81
414507412	IVR 145 3/4" + S20	3/4"	1	833,83
414510412	IVR 145 1" + S20	1"	1	862,95
414512428	IVR 145 1"1/4 + S35	1"1/4	1	1.019,20
414515428	IVR 145 1"1/2 + S55	1"1/2	1	1.399,79
414520509	IVR 145 2" + S140	2"	1	2.160,89



## IVR 685 + IVR 272 M



IVR 685 - Valvola a sfera a corpo piatto flangiata in acciaio inox - flangia ISO 5211 - attacchi flangiati PN16 + IVR 272 - MH - attuatori elettrici a 1/4 di giro - 230 V - 50 Hz - monofase c.a.

IVR 685 - WAFER flanged ball valve PN16 - stainless steel - ISO 5211 flange + IVR 272 - MH - electrical quarter-turn actuators - 230 V - 50 Hz - 1-phase a.c.

IVR 685 - Kugelhahn mit flachem, angeflanschem Körper aus Edelstahl - Flansch ISO 5211 - Flanschanschlüsse PN16 + IVR 272 - MH - elektrische Antriebe mit 1/4-Umdrehung - 230 V - 50 Hz - einphasiger Wechselstrom

IVR 685 - Vanne à boisseau sphérique à corps plat bride en acier inox - bride ISO 5211 - fixations bridées PN16 + IVR 272 - MH - servomoteur électriques à 1/4 de tour - 230 V - 50 Hz - monophasé c.a.

IVR 685 - шаровой кран с укороченным корпусом из нержавеющей стали - фланец ISO 5211 - фланцевое соединение PN16 + IVR 272 - MH - электроприводы на 1/4 оборота - 230 V - 50 Hz - однофазный переменный ток

Cod./Code	Mod./Model	DN	□/田	€
468505412	IVR 685 DN 15 + S20	15	1	825,66
468507412	IVR 685 DN 20 + S20	20	1	841,21
468510412	IVR 685 DN 25 + S20	25	1	859,27
468512412	IVR 685 DN 32 + S20	32	1	883,88
468515428	IVR 685 DN 40 + S35	40	1	1.007,75
468520428	IVR 685 DN 50 + S35	50	1	1.067,59
468525509	IVR 685 DN 65 + S140	65	1	2.141,21
468530528	IVR 685 DN 80 + S300	80	1	2.732,55
468540528	IVR 685 DN100 + S300	100	1	3.047,01



## IVR 664 + IVR 272 M



IVR 664 Valvola a sfera in due pezzi in acciaio inox AISI 316 - attacchi flangiati - flangia ISO 5211 + IVR 272 - attuatore elettrico multitemperatura a 1/4 di giro - da 24 V ac/dc a 240 V ac/dc

IVR 664 Two-piece ball valve in AISI 316 stainless steel - flanged connections - ISO 5211 flange + IVR 272 - 1/4 turn multivoltage electric actuator - from 24 V ac/dc to 240 V ac/dc

IVR 664 Zweiteiliger Kugelhahn aus Edelstahl AISI 316 - Flanschverbindungen - Flansch ISO 5211 + IVR 272 - Mehrspannungs-Elektroantrieb mit 1/4 Umdrehung - von 24 V ac/dc bis 240 V ac/dc

IVR 664 Vanne à boisseau sphérique en deux parties en acier inoxydable AISI 316 - raccords à brides - bride ISO 5211 + IVR 272 - servomoteur électrique multivoltage 1/4 de tour - de 24 V ac/dc à 240 V ac/dc

IVR 664 Двухсоставной шаровой кран из нержавеющей стали AISI 316 - фланцевые соединения - фланец ISO 5211 + IVR 272 - мультивольтный электропривод на 1/4 оборота - от 24 В переменного / постоянного тока до 240 В переменного / постоянного тока

Cod./Code	Mod./Model	DN	□/田	€
466405412	IVR 664 DN 15 + S20	15	1	845,80
466407412	IVR 664 DN 20 + S20	20	1	881,74
466410412	IVR 664 DN 25 + S20	25	1	920,33
466412412	IVR 664 DN 32 + S35	32	1	997,52
466415428	IVR 664 DN 40 + S35	40	1	1.123,82
466420428	IVR 664 DN 50 + S35	50	1	1.228,66
466425509	IVR 664 DN 65 + S85	65	1	2.413,29
466430528	IVR 664 DN 80 + S140	80	1	2.971,71
466440528	IVR 664 DN100 + S140	100	1	3.273,42





## IVR 668 + IVR 272 M



IVR 668 Valvola a sfera in tre pezzi in acciaio inox AISI 316 - attacchi flangiati - flangia ISO 5211 + IVR 272 - attuatore elettrico multitemensione a 1/4 di giro - da 24 Vac/dc a 240 Vac/dc

IVR 668 Three-piece ball valve in AISI 316 stainless steel - flanged connections - ISO 5211 flange + IVR 272 - 1/4 turn multivoltage electric actuator - from 24 Vac / dc to 240 Vac / dc

IVR 668 Dreiteiliger Kugelhahn aus Edelstahl AISI 316 - Flanschverbindungen - Flansch ISO 5211 + IVR 272 - Mehrspannungs-Elektromotor mit 1/4 Umdrehung - von 24 VAC / DC bis 240 VAC / DC

IVR 668 Vanne à boisseau sphérique trois pièces en acier inoxydable AISI 316 - raccords à brides - bride ISO 5211 + IVR 272 - servomoteur électrique multivoltage 1/4 de tour - de 24 Vac / dc à 240 Vac / dc

IVR 668 Трёхсоставной шаровой кран из нержавеющей стали AISI 316 - фланцевые соединения - фланец ISO 5211 + IVR 272 - мультивольтный электропривод на 1/4 оборота - от 24 В переменного / постоянного тока до 240 В переменного / постоянного тока

Cod./Code	Mod./Model	DN	□/⊕	€
466805412	IVR 668 DN 15 + S20	15	1	826,44
466807412	IVR 668 DN 20 + S20	20	1	867,26
466810412	IVR 668 DN 25 + S20	25	1	894,90
466812412	IVR 668 DN 32 + S35	32	1	972,54
466815428	IVR 668 DN 40 + S35	40	1	1.089,63
466820428	IVR 668 DN 50 + S35	50	1	1.188,30
466825509	IVR 668 DN 65 + S85	65	1	2.365,98
466830528	IVR 668 DN 80 + S140	80	1	2.951,53
466840528	IVR 668 DN100 + S140	100	1	3.298,91



## IVR 665 + IVR 218



IVR 665 Valvola a sfera a passaggio totale in tre pezzi in acciaio inox AISI 316 - attacchi F/F - flangia ISO 5211 + IVR 218 Motorhead ISO 5211, con sblocco manuale, per valvole serie Automat L, bidirezionale, comando a 3 punti, 1 micro supplementare libero in apertura di serie

IVR 665 Three-piece full bore ball valve in stainless steel AISI 316 - threaded ends F/F - ISO 5211 flange + IVR 218 Motorhead ISO 5211, with manual release, for Automat L valves, bidirectional, 3 contact terminals, 1 auxiliary microswitch included, free on opening

IVR 665 Kugelhahn dreiteilig mit vollem Durchgang aus Edelstahl AISI 316 - IG/IG - Flansch ISO 5211 + IVR 218 Motorhead ISO 5211, mit Handauslösung, für die Kugelventile der Serie Automat L, bidirektional, 3-Punkt-Steuerung, mit einem zusätzlichen Mikroschalter beim Öffnen ausgestattet

IVR 665 Vanne à boisseau sphérique à passage intégral en trois pièces en acier inox AISI 316 - fixations F/F - bride ISO 5211 + IVR 218 Motorhead ISO 5211 avec débloquage manuel, pour les vannes Automat L, bidirectionnelle, 3 points, 1 micro-interrupteur inclus libre en position d'ouverture

IVR 665 Трёхсоставной полнопроходной шаровой кран из нержавеющей стали AISI 316 - Соединения В/В - фланец ISO 5211 + IVR 218 Motorhead ISO 5211 ручного управления для кранов серии Automat L, двунаправленный, 3 контактных зажима, 1 вспомогательный микровыключатель свободный для подключения.

Cod./Code	Mod./Model	Mis./Size	□/⊕	€
466502250	MH 218 B F03	1/4"	1	242,01
466503250	MH 218 B F03	3/8"	1	242,01
466505250	MH 218 B F03	1/2"	1	244,49
466507268	MH 218 B F04	3/4"	1	289,79
466510268	MH 218 B F04	1"	1	302,04



## IVR 670 + IVR 218



IVR 670 Valvola a sfera a passaggio totale in tre pezzi in acciaio inox AISI 316 - attacchi a saldare - flangia ISO 5211 + IVR 218 Motorhead ISO 5211, con sblocco manuale, per valvole serie Automat L, bidirezionale, comando a 3 punti, 1 micro supplementare libero in apertura di serie

IVR 670 Three-piece full bore ball valve in stainless steel AISI 316 - Butt weld connections - ISO 5211 flange + IVR 218 Motorhead ISO 5211, with manual release, for Automat L valves, bidirectional, 3 contact terminals, 1 auxiliary microswitch included, free on opening

IVR 670 Kugelhahn dreiteilig mit vollem Durchgang aus Edelstahl AISI 316 - Schweissenden - Flansch ISO 5211 + IVR 218 Motorhead ISO 5211, mit Handauslösung, für die Kugelventile der Serie Automat L, bidirektional, 3-Punkt-Steuerung, mit einem zusätzlichen Mikroschalter beim Öffnen ausgestattet

IVR 670 Vanne à boisseau sphérique à passage intégral en trois pièces en acier inox AISI 316 - fixations F/F - bride ISO 5211 + IVR 218 Motorhead ISO 5211 avec débloquage manuel, pour les vannes Automat L, bidirectionnelle, 3 points, 1 micro-interrupteur inclus libre en position d'ouverture

IVR 670 Трёхсоставной полнопроходной шаровой кран из нержавеющей стали AISI 316 - Соединения под приварку - фланец ISO 5211 + IVR 218 Motorhead ISO 5211 ручного управления для кранов серии Automat L, двунаправленный, 3 контактных зажима, 1 вспомогательный микровыключатель свободный для подключения.

Cod./Code	Mod./Model	Mis./Size	□/⊕	€
467002250	MH 218 B F03	1/4"	1	240,86
467003250	MH 218 B F03	3/8"	1	240,86
467005250	MH 218 B F03	1/2"	1	243,32
467007268	MH 218 B F04	3/4"	1	288,25
467010268	MH 218 B F04	1"	1	299,76



## IVR 672 + IVR 218



IVR 672 Valvola a sfera a passaggio totale in tre pezzi in acciaio inox AISI 316 - attacchi a saldare di tasca - flangia ISO 5211 + IVR 218 Motorhead ISO 5211, con sblocco manuale, per valvole serie Automat L, bidirezionale, comando a 3 punti, 1 micro supplementare libero in apertura di serie

IVR 672 Three-piece full bore ball valve in stainless steel AISI 316 - Socked weld connection - ISO 5211 flange + IVR 218 Motorhead ISO 5211, with manual release, for Automat L valves, bidirectional, 3 contact terminals, 1 auxiliary microswitch included, free on opening

IVR 672 Kugelhahn dreiteilig mit vollem Durchgang aus Edelstahl AISI 316 - Schweißanschlüsse - Flansch ISO 5211 + IVR 218 Motorhead ISO 5211, mit Handauslösung, für die Kugelventile der Serie Automat L, bidirektional, 3-Punkt-Steuerung, mit einem zusätzlichen Mikroschalter beim Öffnen gestattet

IVR 672 Vanne à boisseau sphérique à passage intégral en trois pièces en acier inox AISI 316 - fixations à souder de poche - bride ISO 5211 + IVR 218 Motorhead ISO 5211 avec déblocage manuel, pour les vannes Automat L, bidirectionnelle, 3 points, 1 micro-interrupteur inclus libre en position d'ouverture

IVR 672 Трёхсоставной полнопроходной шаровой кран из нержавеющей стали AISI 316 - Соединения под приварку (карман) - фланец ISO 5211 + IVR 218 Motorhead ISO 5211 ручного управления для кранов серии Automat L, двунаправленный, 3 контактных зажима, 1 вспомогательный микровыключатель свободный для подключения.

Cod./Code	Mod./Model	Mis./Size	□/田	€
467202250	MH 218 B F03	1/4"	1	242,48
467203250	MH 218 B F03	3/8"	1	242,48
467205250	MH 218 B F03	1/2"	1	244,94
467207268	MH 218 B F04	3/4"	1	290,71
467210268	MH 218 B F04	1"	1	302,63



## IVR 144 L + IVR 218



IVR 144 L Valvola a sfera in acciaio inox AISI 316 tre vie passaggio ridotto - sfera forata a L - attacchi F/F/F - flangia ISO 5211 + IVR 218 Motorhead ISO 5211, con sblocco manuale, per valvole serie Automat L, bidirezionale, comando a 3 punti, 1 micro supplementare libero in apertura di serie

IVR 144 L 3-way reduced bore ball valve in stainless steel AISI 316 - Bored ball as L - threaded ends F/F/F - ISO 5211 flange + IVR 218 Motorhead ISO 5211, with manual release, for Automat L valves, bidirectional, 3 contact terminals, 1 auxiliary microswitch included, free on opening

IVR 144 L 3-Wege-Kugelhahn aus Edelstahl AISI 316 mit reduziertem Durchgang - Kugel mit L-Bohrung - IG/IG - Flansch ISO 5211 + IVR 218 Motorhead ISO 5211, mit Handauslösung, für die Kugelventile der Serie Automat L, bidirektional, 3-Punkt-Steuerung, mit einem zusätzlichen Mikroschalter beim Öffnen gestattet

IVR 144 L Vanne à boisseau sphérique à passage réduit - sphère percée en L - fixations F/F/F - bride ISO 5211 + IVR 218 Motorhead ISO 5211 avec déblocage manuel, pour les vannes Automat L, bidirectionnelle, 3 points, 1 micro-interrupteur inclus libre en position d'ouverture

IVR 144 L Трёхходовой шаровой кран из нерж. стали AISI 316 с редуцированным проходом - L-образный проход шара - Соединения В/В/В - фланец ISO 5211 + IVR 218 Motorhead ISO 5211 ручного управления для кранов серии Automat L, двунаправленный, 3 контактных зажима, 1 вспомогательный микровыключатель свободный для подключения.

Cod./Code	Mod./Model	Mis./Size	□/田	€
414402250	MH 218 B F03	1/4"	1	275,23
414403250	MH 218 B F03	3/8"	1	275,23
414405250	MH 218 B F03	1/2"	1	276,70
414407268	MH 218 B F04	3/4"	1	324,23



## IVR 145 T + IVR 218



IVR 145 T Valvola a sfera in acciaio inox AISI 316 tre vie passaggio ridotto - sfera forata a T - attacchi F/F/F - flangia ISO 5211 + IVR 218 Motorhead ISO 5211, con sblocco manuale, per valvole serie Automat L, bidirezionale, comando a 3 punti, 1 micro supplementare libero in apertura di serie

IVR 145 T 3-way reduced bore ball valve in stainless steel AISI 316 - Bored ball as T - threaded ends F/F/F - ISO 5211 flange + IVR 218 Motorhead ISO 5211, with manual release, for Automat L valves, bidirectional, 3 contact terminals, 1 auxiliary microswitch included, free on opening

IVR 145 T 3-Wege-Kugelhahn aus Edelstahl AISI 316 mit reduziertem Durchgang - Kugel mit T-Bohrung - IG/IG - Flansch ISO 5211 + IVR 218 Motorhead ISO 5211, mit Handauslösung, für die Kugelventile der Serie Automat L, bidirektional, 3-Punkt-Steuerung, mit einem zusätzlichen Mikroschalter beim Öffnen gestattet

IVR 145 T Vanne à boisseau sphérique en acier inox AISI 316 trois voies passage réduit - sphère percée en T - fixations F/F/F - bride ISO 5211 + IVR 218 Motorhead ISO 5211 avec déblocage manuel, pour les vannes Automat L, bidirectionnelle, 3 points, 1 micro-interrupteur inclus libre en position d'ouverture

IVR 145 Трёхходовой шаровой кран из нерж. стали AISI 316 с редуцированным проходом - T-образный проход шара - Соединения В/В/В - фланец ISO 5211 + IVR 218 Motorhead ISO 5211 ручного управления для кранов серии Automat L, двунаправленный, 3 контактных зажима, 1 вспомогательный микровыключатель свободный для подключения.

Cod./Code	Mod./Model	Mis./Size	□/田	€
414502250	MH 218 B F03	1/4"	1	275,23
414503250	MH 218 B F03	3/8"	1	275,23
414505250	MH 218 B F03	1/2"	1	275,23
414507268	MH 218 B F04	3/4"	1	324,23





## IVR 685 + IVR 218



EAC CE

IVR 685 Valvola a sfera a corpo piatto in acciaio inox AISI 316 - Flangia ISO 5211 e attacchi flangiati PN 16 + IVR 218 Motorhead ISO 5211, con sblocco manuale, per valvole serie Automat L, bidirezionale, comando a 3 punti, 1 micro supplementare libero in apertura di serie

IVR 685 AISI 316 stainless steel ball valve - ISO 5211 flange - Flanged ends PN16 + IVR 218 Motorhead ISO 5211, with manual release, for Automat L valves, bidirectional, 3 contact terminals, 1 auxiliary microswitch included, free on opening

IVR 685 Kugelhahn mit Flachkörper aus Edelstahl AISI 316 - Flansch ISO 5211 und Flanschanschlüsse PN 16 + IVR 218 Motorhead ISO 5211, mit Handauslösung, für die Kugelventile der Serie Automat L, bidirektional, 3-Punkt-Steuerung, mit einem zusätzlichen Mikroschalter beim Öffnen ausgestattet

IVR 685 Vanne à boisseau sphérique à corps plat en acier inox AISI 316 - Bride ISO 5211 et fixations bridées PN 16 + IVR 218 Motorhead ISO 5211 avec déblocage manuel, pour les vannes Automat L, bidirectionnelle, 3 points, 1 micro-interrupteur inclus libre en position d'ouverture

IVR 685 Шаровой кран с укороченным корпусом из нержавеющей стали AISI 316 - фланец ISO 5211 - фланцевое соединение PN 16 + IVR 218 Motorhead ISO 5211 ручного управления для кранов серии Automat L, двунаправленный, 3 контактных зажима, 1 вспомогательный микровыключатель свободный для подключения.

Cod./Code	Mod./Model	DN	□/田	€
468505250	MH 218 B F03	15	1	284,34
468507250	MH 218 B F03	20	1	300,27
468510268	MH 218 B F04	25	1	349,60



## IVR 272 M

NEW



EAC

IVR 272 - attuatore elettrico multitemperatura a 1/4 di giro - da 24 V ac/dc a 240 V ac/dc

IVR 272 - Multi-voltage electrical quarter-turn actuators - from 24 V ac/dc to 240 V ac/dc

IVR 272 - Mehrspannungs-Elektroaktuator mit 1/4 Umdrehung - von 24 V ac/dc bis 240 V ac/dc

IVR 272 - actionneur électrique multitemperatura à 1/4 de tour - de 24 V ac/dc à 240 V ac/dc

IVR 272 - многовольтный электропривод на 1/4 оборота - от 24 В пер. т. / пост. т. до 240 В пер. т. / пост. т.

Cod./Code	Mod./Model	□/田	€
127202001	S20 F03/F04/F05 Q.14	1	713,73
127203501	S35 F03/F04/F05 Q.14	1	865,65
127205501	S55 F05/F07 Q.17	1	1.204,68
127208501	S85 F05/F07 Q.17	1	1.356,59
127214001	S140 F07/F10 Q.22	1	1.903,13
127230001	S300 F07/F10 Q.22	1	2.068,01
127275393	PSQ 503 230v 93s	1	2.141,18
127285393	PSQ 703 230v 93s	1	2.194,71



## IVR 218 3P



EAC CE

IVR 218 Motorhead ISO 5211, con sblocco manuale, per valvole serie Automat L, bidirezionale, comando a 3 punti, 1 micro supplementare libero in apertura di serie

IVR 218 Motorhead ISO 5211, with manual release, for Automat L valves, bidirectional, 3 contact terminals, 1 auxiliary microswitch included, free on opening

IVR 218 Motorhead ISO 5211, mit Handauslösung, für die Kugelventile der Serie Automat L, bidirektional, 3-Punkt-Steuerung, mit einem zusätzlichen Mikroschalter beim Öffnen ausgestattet

IVR 218 Motorhead ISO 5211 avec déblocage manuel, pour les vannes Automat L, bidirectionnelle, 3 points, 1 micro-interrupteur inclus libre en position d'ouverture

IVR 218 Motorhead ISO 5211 с ручным управлением для кранов серии Automat L, двунаправленный, 3 контактных зажима, 1 вспомогательный микровыключатель свободный для подключения.

Cod./Code	Mod./Model	ISO	□/田	€
121833520	230V - 11Nm 35 sec. - 3 contact	F03	1/10	207,62
121843520	230V - 14Nm 35 sec. - 2 contact	F04	1/10	238,63



## VALVOLE INDUSTRIALI CON ATTUATORI PNEUMATICI INDUSTRIAL VALVES WITH PNEUMATIC ACTUATORS

### IVR 662 + IVR 270



IVR 662 - Valvola a sfera in acciaio inox - attacchi F/F - flangia ISO 5211 + IVR 270 - Attuatore pneumatico rotante - DOPPIO EFFETTO

IVR 662 - Ball valve in stainless steel - F/F - flange ISO 5211 + IVR 270 - Pneumatic rotary actuator - DOUBLE ACTING

IVR 662 - Kugelhahn aus rostfreiem Stahl AISI 316 - IG/IG - Flansche ISO 5211 + IVR 270 - Pneumatischer Drehantrieb - DOPPELWIRKEND

IVR 662 - Vanne à boisseau sphérique en acier inox AISI 316 - F/F - Bride ISO 5211 + IVR 270 - Actuateur pneumatique tournant - DOUBLE EFFET

Кран шаровой из нержавеющей стали - соединения В/В - фланец ISO 5211+ IVR 270 - Пневматический поворотный привод - ДВОЙНОГО ДЕЙСТВИЯ

Cod./Code	Mod./Model	Mis./Size	□/田	€
466202600	IVR 662 1/4" + AT40 DE	1/4"	1	144,39
466203600	IVR 662 3/8" + AT40 DE	3/8"	1	164,87
466205602	IVR 662 1/2" + AT40 DE	1/2"	1	164,87
466207604	IVR 662 3/4" + AT40 DE	3/4"	1	165,89
466210604	IVR 662 1" + AT52 DE	1"	1	195,99
466212607	IVR 662 1"1/4 + AT63 DE	1"1/4	1	240,92
466215607	IVR 662 1"1/2 + AT63 DE	1"1/2	1	269,45
466220607	IVR 662 2" + AT63 DE	2"	1	303,10
466225615	IVR 662 2"1/2 + AT83 DE	2"1/2	1	530,18
466230615	IVR 662 3" + AT92 DE	3"	1	603,85
466240617	IVR 662 4" + AT105 DE	4"	1	966,17



### IVR 665 + IVR 270



IVR 665 - Valvola a sfera in tre pezzi in acciaio inox - attacchi F/F - flangia ISO 5211 + IVR 270 - Attuatori Pneumatici rotanti - DOPPIO EFFETTO

IVR 665 - 3-piece ball valve in stainless steel - threaded ends F/F - ISO 5211 flange + IVR 270 - Pneumatic rotary actuators - DOUBLE ACTING

IVR 665 - Kugelhahn, dreiteilig, aus Edelstahl - IG/IG- Flansch ISO 5211 + IVR 270 - Rotierende Drehantriebe - DOPPELWIRKEND

IVR 665 - Vanne à boisseau sphérique en trois pièces en acier inox - fixations F/F - bride ISO 5211 + IVR 270 - Actuateurs Pneumatiques tournants - DOUBLE EFFET

IVR 665 - трёхсоставной шаровой кран из нержавеющей стали - соединения В/В - фланец ISO 5211 + IVR 270 - Пневматические поворотные приводы - ДВОЙНОГО ДЕЙСТВИЯ

Cod./Code	Mod./Model	Mis./Size	□/田	€
466502600	IVR 665 DN 1/4" + AT40 DE	1/4"	1	150,64
466503600	IVR 665 DN 3/8" + AT40 DE	3/8"	1	171,12
466505602	IVR 665 DN 1/2" + AT40 DE	1/2"	1	173,47
466507604	IVR 665 DN 3/4" + AT40 DE	3/4"	1	184,14
466510604	IVR 665 DN 1" + AT52 DE	1"	1/4	213,93
466512607	IVR 665 DN 1"1/4 + AT63 DE	1"1/4	1	268,79
466515607	IVR 665 DN 1"1/2 + AT63 DE	1"1/2	1	295,14
466520607	IVR 665 DN 2" + AT63 DE	2"	1	331,71
466525615	IVR 665 DN 2"1/2 + AT83 DE	2"1/2	1	611,35
466530615	IVR 665 DN 3" + AT92 DE	3"	1	755,42
466540617	IVR 665 DN 4" + AT105 DE	4"	1	1.122,93



## IVR 663 + IVR 270



IVR 663 - Valvola a sfera in tre pezzi in acciaio inox - attacchi F/F- flangia ISO 5211 + IVR 270 - Attuatore pneumatico rotante - DOPPIO EFFETTO

IVR 663 - Three-piece full bore ball valve in stainless steel AISI 316 - F/F - ISO 5211 flange + IVR 270 - Pneumatic rotary actuator - DOUBLE ACTING

IVR 663 - Kugelhahn, dreiteilig, aus Edelstahl - IG/IG- Flansch ISO 5211 + IVR 270 - Rotierender Drehantrieb - DOPPELWIRKEND

IVR 663 - Vanne à boisseau sphérique en trois pièces en acier inox - F/F - bride ISO 5211 + IVR 270 - Actuateur pneumatique tournant - DOUBLE EFFET

IVR 663 - трёхсоставной шаровой кран из нержавеющей стали - соединения В/В - фланец ISO 5211 + IVR 270 - Пневматический поворотный привод - ДВОЙНОГО ДЕЙСТВИЯ

Cod./Code	Mod./Model	Mis./Size	□/田	€
466305602	IVR 663 1/2" + AT40 DE	1/2"	1	179,78
466307604	IVR 663 3/4" + AT40 DE	3/4"	1	194,40
466310604	IVR 663 1" + AT52 DE	1"	1	230,20
466312607	IVR 663 1"1/4 + AT63 DE	1"1/4	1	302,30
466315607	IVR 663 1"1/2 + AT63 DE	1"1/2	1	350,54
466320607	IVR 663 2" + AT63 DE	2"	1	410,98
466325615	IVR 663 2"1/2 + AT83 DE	2"1/2	1	686,30
466330615	IVR 663 3" + AT92 DE	3"	1	815,69
466340617	IVR 663 4" + AT105 DE	4"	1	1.254,33



## IVR 670 + IVR 270



IVR 670 - Valvola a sfera in tre pezzi in acciaio inox - attacchi a saldare- flangia ISO 5211 + IVR 270 - Attuatori Pneumatici rotanti - DOPPIO EFFETTO

IVR 670 - 3-piece ball valve in stainless steel- butt weld connections - ISO 5211 flange + IVR 270 - Pneumatic rotary actuators - DOUBLE ACTING

IVR 670 - Kugelhahn, dreiteilig, aus Edelstahl - Schweissenden- Flansch ISO 5211 + IVR 270 - Rotierende Drehantriebe - DOPPELWIRKEND

IVR 670 - Vanne à boisseau sphérique en trois pièces en acier inox - fixations à souder- bride ISO 5211 + IVR 270 - Actuateurs Pneumatiques tournants - DOUBLE EFFET

IVR 670 - трёхсоставной шаровой кран из нержавеющей стали - соединения под приварку - фланец ISO 5211 + IVR 270 - Пневматические поворотные приводы - ДВОЙНОГО ДЕЙСТВИЯ

Cod./Code	Mod./Model	Mis./Size	□/田	€
467003600	IVR 670 DN 3/8" + AT40 DE	3/8"	1	170,11
467005602	IVR 670 DN 1/2" + AT40 DE	1/2"	1	172,19
467007604	IVR 670 DN 3/4" + AT40 DE	3/4"	1	182,37
467010604	IVR 670 DN 1" + AT52 DE	1"	1	212,17
467012607	IVR 670 DN 1"1/4 + AT63 DE	1"1/4	1	264,76
467015607	IVR 670 DN 1"1/2 + AT63 DE	1"1/2	1	290,70
467020607	IVR 670 DN 2" + AT63 DE	2"	1	328,54
467025615	IVR 670 DN 2"1/2 + AT83 DE	2"1/2	1	604,69
467030615	IVR 670 DN 3" + AT92 DE	3"	1	745,54
467040617	IVR 670 DN 4" + AT105 DE	4"	1	1.107,00



## IVR 672 + IVR 270



IVR 672 - Valvola a sfera a passaggio totale in tre pezzi in acciaio inox AISI 316 - attacchi a saldare di tasca - flangia ISO 5211 + IVR 270 - Attuatori Pneumatici rotanti - DOPPIO EFFETTO

IVR 672 - Three-piece full bore ball valve in stainless steel AISI 316 - Socked weld connection - ISO 5211 flange + IVR 270 - Pneumatic rotary actuators - DOUBLE ACTING

IVR 672 - Kugelhahn dreiteilig mit vollem Durchgang aus Edelstahl AISI 316 - Schweißanschlüsse - Flansch ISO 5211 + IVR 270 - Rotierende Drehantriebe - DOPPELWIRKEND

IVR 672 - Vanne à boisseau sphérique à passage intégral en trois pièces en acier inox AISI 316 - fixations à souder de poche - bride ISO 5211 + IVR 270 - Actuateurs Pneumatiques tournants - DOUBLE EFF

IVR 672 - трёхсоставной полнопроходной шаровой кран из нержавеющей стали AISI 316 - Соединения под приварку (карман) - фланец ISO 5211 + IVR 270 - Пневматические поворотные приводы - ДВОЙНОГО ДЕЙСТВИЯ

Cod./Code	Mod./Model	Mis./Size	□/田	€
467202600	IVR 672 DN 1/4" + AT40 DE	1/4"	1	151,43
467203600	IVR 672 DN 3/8" + AT40 DE	3/8"	1	171,76
467205602	IVR 672 DN 1/2" + AT40 DE	1/2"	1	173,83
467207604	IVR 672 DN 3/4" + AT40 DE	3/4"	1	184,87
467210604	IVR 672 DN 1" + AT52 DE	1"	1	215,09
467212607	IVR 672 DN 1"1/4 + AT63 DE	1"1/4	1	269,37
467215607	IVR 672 DN 1"1/2 + AT63 DE	1"1/2	1	296,51
467220607	IVR 672 DN 2" + AT63 DE	2"	1	335,40
467225615	IVR 672 DN 2"1/2 + AT83 DE	2"1/2	1	620,98
467230615	IVR 672 DN 3" + AT92 DE	3"	1	767,75
467240615	IVR 672 DN 4" + AT105 DE	4"	1	1.144,39



## IVR 144 L + IVR 270



IVR 144L - Valvola a sfera a passaggio ridotto a tre vie in acciaio inox AISI 316 - sfera forata a L - attacchi F/F/F - flangia ISO 521 + IVR 270 - Attuatori Pneumatici rotanti - DOPPIO EFFETTO

IVR 144L - 3-way reduce bore ball valve in stainless steel AISI 316 - bored ball as L - threaded ends F/F/F - ISO 5211 flange + IVR 270 - Pneumatic rotary actuators - DOUBLE ACTING

IVR 144L - 3-Wege-Kugelhahn mit reduziertem Durchgang aus Edelstahl AISI 316 - Kugel mit L-Bohrung- IG/IG/IG - Flansch ISO 521 + IVR 270 - Rotierende Drehantriebe - DOPPELWIRKEND

IVR 144L - Vanne à boisseau sphérique à passage réduit à trois voies en acier inox AISI 316 - sphère percée en L - fixations F/F/F - bride ISO 5211 + IVR 270 - Actuateurs Pneumatiques tournants - DOUBLE EFFET

IVR 144L - трёхходовый шаровой кран из нержавеющей стали AISI 316 с редуцированным проходом - L-образный проход шара - соединения В/В/В - фланец ISO 5211 + IVR 270 - Пневматические поворотные приводы - ДВОЙНОГО ДЕЙСТВИЯ

Cod./Code	Mod./Model	Mis./Size	□/田	€
414402600	IVR 144L 1/4" + AT40 DE	1/4"	1	204,83
414403600	IVR 144L 3/8" + AT40 DE	3/8"	1	204,83
414405600	IVR 144L 1/2" + AT40 DE	1/2"	1	204,83
414407604	IVR 144L 3/4" + AT40 DE	3/4"	1	219,17
414410604	IVR 144L 1" + AT52 DE	1"	1	266,91
414412607	IVR 144L 1"1/4 + AT63 DE	1"1/4	1	374,76
414415610	IVR 144L 1"1/2 + AT63 DE	1"1/2	1	434,25
414420615	IVR 144L 2" + AT63 DE	2"	1	663,28



## IVR 145 T + IVR 270



IVR 145T - Valvola a sfera a passaggio ridotto a tre vie in acciaio inox AISI 316 - sfera forata a T - attacchi F/F/F - flangia ISO 5211 6 + IVR 270 - Attuatori Pneumatici rotanti - DOPPIO EFFETTO

IVR 145T - 3-way reduced bore ball valve in stainless steel AISI 316 - bored ball as T - threaded ends F/F/F - ISO 5211 flange + IVR 270 - Pneumatic rotary actuators - DOUBLE ACTING

IVR 145T - 3-Wege-Kugelhahn mit reduziertem Durchgang aus Edelstahl AISI 316 - Kugel mit T-Bohrung- IG/IG/IG - Flansch ISO 5211 6 + IVR 270 - Rotierende Drehantriebe - DOPPELWIRKEND

IVR 145T - Vanne à boisseau sphérique à passage réduit à trois voies en acier inox AISI 316 - sphère percée en T - fixations F/F/F - bride ISO 5211 + IVR 270 - Actuateurs Pneumatiques tournants - DOUBLE EFFET

IVR 145T - трёхходовый шаровой кран из нержавеющей стали AISI 316 с редуцированным проходом - T-образный проход шара - соединения В/В/В - фланец ISO 5211 + IVR 270 - Пневматические поворотные приводы - ДВОЙНОГО ДЕЙСТВИЯ

Cod./Code	Mod./Model	Mis./Size	□/田	€
414502600	IVR 145T 1/4" + AT40 DE	1/4"	1	204,83
414503600	IVR 145T 3/8" + AT40 DE	3/8"	1	204,83
414505600	IVR 145T 1/2" + AT40 DE	1/2"	1	204,83
414507604	IVR 145T 3/4" + AT40 DE	3/4"	1	218,74
414510604	IVR 145T 1" + AT52 DE	1"	1	266,51
414512607	IVR 145T 1"1/4 + AT63 DE	1"1/4	1	373,50
414515610	IVR 145T 1"1/2 + AT63 DE	1"1/2	1	432,58
414520615	IVR 145T 2" + AT63 DE	2"	1	656,84



## IVR 685 + IVR 270



IVR 685 - Valvola a sfera a corpo piatto flangiata in acciaio inox - flangia ISO 5211 - attacchi flangiati PN16 + IVR 270 - Attuatori Pneumatici rotanti - DOPPIO EFFETTO

IVR 685 - WAFER flanged ball valve PN16 - stainless steel - ISO 5211 flange + IVR 270 - Pneumatic rotary actuators - DOUBLE ACTING

IVR 685 - Kugelhahn mit flachem, angeflanschem Körper aus Edelstahl - Flansch ISO 5211 - Flanschanschlüsse PN16 + IVR 270 - Rotierende Drehantriebe - DOPPELWIRKEND

IVR 685 - Vanne à boisseau sphérique à corps plat bridée en acier inox - bride ISO 5211 - fixations bridées PN16 + IVR 270 - Actuateurs Pneumatiques tournants - DOUBLE EFFET

IVR 685 - Шаровой кран с укороченным корпусом из нержавеющей стали - фланец ISO 5211 - фланцевое соединение PN16 + IVR 270 - Пневматические поворотные приводы - ДВОЙНОГО ДЕЙСТВИЯ

Cod./Code	Mod./Model	DN	□/田	€
468505600	IVR 685 DN 15 + AT40 DE	15	1	215,24
468507602	IVR 685 DN 20 + AT40 DE	20	1	232,17
468510604	IVR 685 DN 25 + AT40 DE	25	1	245,50
468512604	IVR 685 DN 32 + AT52 DE	32	1	288,86
468515607	IVR 685 DN 40 + AT63 DE	40	1	361,28
468520610	IVR 685 DN 50 + AT63 DE	50	1	440,89
468525617	IVR 685 DN 65 + AT105 DE	65	1	817,37
468530620	IVR 685 DN 80 + AT125 DE	80	1	977,68
468540622	IVR 685 DN 100 + AT140 DE	100	1	1.434,33
468550676	IVR 685 DN 125 + AT140 DE	125	1	2.796,72





## IVR 664 + IVR 270



IVR 664 Valvola a sfera in due pezzi in acciaio inox AISI 316 - attacchi flangiati - flangia ISO 5211 + IVR 270 - DA - Attuatori Pneumatici rotanti - DOPPIO EFFETTO

IVR 664 Two-piece ball valve in stainless steel AISI 316 - flanged connections - ISO 5211 flange + IVR 270 - DA - Pneumatic rotary actuators - DOUBLE ACTING

IVR 664 Zweiteiliger Kugelhahn aus rostfreiem Stahl AISI 316 mit Flanschanschlüssen - Flansche ISO 5211 + IVR 270 - DA - Rotierende Drehantriebe - DOPPELWIRKEND

IVR 664 Vanne à boisseau sphérique à deux pièces en acier inox AISI 316 - fixations bridées - bride ISO 5211 + IVR 270 - DA - Actuateurs pneumatiques tournants - DOUBLE EFFET

IVR 664 Двухсоставной полнопроходной шаровой кран из нержавеющей стали AISI 316 - фланцевые соединения - фланец ISO 5211 + IVR 270 - Пневматический поворотный привод - ДВОЙНОГО ДЕЙСТВИЯ

Cod./Code	Mod./Model	DN	□/田	€
466405600	IVR 664 DN 15 + AT40 DE	15	1	243,15
466407602	IVR 664 DN 20 + AT40 DE	20	1	280,24
466410604	IVR 664 DN 25 + AT40 DE	25	1	313,95
466412604	IVR 664 DN 32 + AT52 DE	32	1	408,44
466415607	IVR 664 DN 40 + AT63 DE	40	1	482,95
466420610	IVR 664 DN 50 + AT63 DE	50	1	606,05
466425617	IVR 664 DN 65 + AT83 DE	65	1	1.100,63
466430620	IVR 664 DN 80 + AT92 DE	80	1	1.283,66
466440622	IVR 664 DN 100 + AT105 DE	100	1	1.722,76



## IVR 668 + IVR 270



IVR 668 Valvola a sfera in tre pezzi in acciaio inox AISI 316 - attacchi flangiati - flangia ISO 5211 + IVR 270 - DA - Attuatori Pneumatici rotanti - DOPPIO EFFETTO

IVR 668 Three-piece ball valve in stainless steel AISI 316 - flanged connections - flange ISO 5211 + IVR 270 - DA - Pneumatic rotary actuators - DOUBLE ACTING

IVR 668 Kugelhahn dreiteilig aus Inoxstahl AISI 316 - mit geflanschten Gewinden - Flansche ISO 5211 + IVR 270 - DA - Rotierende Drehantriebe - DOPPELWIRKEND

IVR 668 Vanne à boisseau sphérique en trois pièces en acier inox AISI 316 - fixations bridées - bride ISO 5211 + IVR 270 - DA - Actuateurs pneumatiques tournants - DOUBLE EFFET

IVR 668 Трёхсоставной кран из нержавеющей стали AISI 316 - фланцевые соединения - фланец ISO 5211 + IVR 270 - Пневматический поворотный привод - ДВОЙНОГО ДЕЙСТВИЯ

Cod./Code	Mod./Model	DN	□/田	€
466805600	IVR 668 DN 15 + AT40 DE	15	1	223,80
466807602	IVR 668 DN 20 + AT40 DE	20	1	265,76
466810604	IVR 668 DN 25 + AT40 DE	25	1	288,52
466812604	IVR 668 DN 32 + AT63 DE	32	1	383,67
466815607	IVR 668 DN 40 + AT63 DE	40	1	448,97
466820610	IVR 668 DN 50 + AT63 DE	50	1	565,67
466825617	IVR 668 DN 65 + AT83 DE	65	1	1.053,30
466830620	IVR 668 DN 80 + AT92 DE	80	1	1.263,50
466840622	IVR 668 DN 100 + AT105 DE	100	1	1.748,00



## IVR 77 + IVR 270



IVR 77 - Valvola flangiata in ghisa GJL 250 - attacchi flangiati PN16 + IVR 270 - Attuatori Pneumatici rotanti - DOPPIO EFFETTO

IVR 77 - Cast iron GJL 250 ball valve - flanged ends PN16 + IVR 270 - Pneumatic rotary actuators - DOUBLE ACTING

IVR 77 - Flansch-Kugelhahn aus Gusseisen GJL 250 - Flanschanschlüsse PN16 + IVR 270 - Rotierende Drehantriebe - DOPPELWIRKEND

IVR 77 - Vanne bride en fonte GJL 250 - fixations bridées PN16 + IVR 270 - Actuateurs Pneumatiques tournants - DOUBLE EFFET

IVR 77 - Шаровой кран из чугуна GJL 250 - фланцевое соединение PN16 + IVR 270 - Пневматические поворотные приводы - ДВОЙНОГО ДЕЙСТВИЯ

Cod./Code	Mod./Model	DN	□/田	€
407707606	IVR 77 DN 20 + AT52 DE F04	20	1	266,92
407710606	IVR 77 DN 25 + AT52 DE F04	25	1	293,84
407712606	IVR 77 DN 32 + AT63 DE F04	32	1	329,56
407715610	IVR 77 DN 40 + AT63 DE	40	1	349,78
407720610	IVR 77 DN 50 + AT63 DE	50	1	393,69
407725611	IVR 77 DN 65 + AT83 DE	65	1	450,67
407730615	IVR 77 DN 80 + AT92 DE	80	1	742,30
407740617	IVR 77 DN 100 + AT105 DE	100	1	810,28
407750620	IVR 77 DN 125 + AT105 DE	125	1	1.157,06
407760620	IVR 77 DN 150 + AT105 DE	150	1	1.428,92



## IVR 78 + IVR 270



IVR 78 - Valvola flangiata in ghisa GJL 250 - asta e sfera inox - attacchi flangiati PN16 + IVR 270 - Attuatori Pneumatici rotanti - DOPPIO EFFETTO

IVR 78 - Cast iron GJL 250 ball valve - inox stem and ball - flanged ends PN16 + IVR 270 - Pneumatic rotary actuators - DOUBLE ACTING

IVR 78 - Flansch-Kugelhahn aus Gusseisen GJL 250 - Stab und Kugel aus Edelstahl - Flanschanschlüsse PN16 + IVR 270 - Rotierende Drehantriebe - DOPPELWIRKEND

IVR 78 - Vanne bride en fonte GJL 250 - tige et sphère inox - fixations bridées PN16 + IVR 270 - Actuateurs pneumatiques tournants - DOUBLE EFFET

IVR 78 - Шаровой кран из чугуна GJL 250 - шток и шар из нержавеющей стали - Фланцевое соединение PN16 + IVR 270 - Пневматические поворотные приводы - ДВОЙНОГО ДЕЙСТВИЯ

Cod./Code	Mod./Model	DN	□/田	€
407807606	IVR 78 DN 20 + AT52 DE F04	20	1	263,52
407810606	IVR 78 DN 25 + AT52 DE F04	25	1	290,60
407812606	IVR 78 DN 32 + AT63 DE F04	32	1	354,53
407815610	IVR 78 DN 40 + AT63 DE	40	1	395,48
407820610	IVR 78 DN 50 + AT63 DE	50	1	442,98
407825611	IVR 78 DN 65 + AT83 DE	65	1	505,04
407830615	IVR 78 DN 80 + AT92 DE	80	1	812,61
407840617	IVR 78 DN 100 + AT105 DE	100	1	934,28
407850620	IVR 78 DN 125 + AT105 DE	125	1	1.350,25
407860620	IVR 78 DN 150 + AT105 DE	150	1	1.864,17



## IVR 276 CF8M + IVR 270



IVR 276 CF8M - Valvola a farfalla in ghisa tipo WAFER - disco inox - attacchi flangiati PN16 + IVR 270 - Attuatori Pneumatici rotanti - DOPPIO EFFETTO

IVR 276 CF8M - Butterfly valve WAFER type - stainless steel disc - flanged ends PN16 + IVR 270 - Pneumatic rotary actuators - DOUBLE ACTING

IVR 276 CF8M - Ventil mit Flügelgriff aus Gusseisen - Typ WAFER - Edstahlscheibe - Flanschanschlüsse PN16 + IVR 270 - Rotierende Drehantriebe - DOPPELWIRKEND

IVR 276 CF8M - Vanne papillon en fonte type WAFER - disque inox - fixations bridées PN16 + IVR 270 - Actuateurs Pneumatiques tournants - DOUBLE EFFET

IVR 276 CF8M - Дисковый затвор Баттерфляй из чугуна - тип WAFER - диск из нержавеющей стали - Фланцевое соединение PN 16 + IVR 270 - Пневматические поворотные приводы - ДВОЙНОГО ДЕЙСТВИЯ

Cod./Code	Mod./Model	DN	□/田	€
427615604	IVR 276 DN 40 + AT63 DE	40	1	318,68
427620604	IVR 276 DN 50 + AT63 DE	50	1	319,55
427625607	IVR 276 DN 65 + AT63 DE	65	1	365,58
427630610	IVR 276 DN 80 + AT63 DE	80	1	399,52
427640611	IVR 276 DN 100 + AT83 DE	100	1	522,31
427650615	IVR 276 DN 125 + AT92 DE	125	1	753,36
427660617	IVR 276 DN 150 + AT105 DE	150	1	808,56
427680622	IVR 276 DN 200 + AT125 DE	200	1	1.190,31
427690626	IVR 276 DN 250 + AT140 DE	250	1	1.919,93
427695629	IVR 276 DN 300 + AT160 DE	300	1	2.960,95



## IVR 175 + IVR 270



IVR 175 - Valvola a farfalla in ghisa tipo LUG - attacchi flangiati PN16 + IVR 270 - Attuatori Pneumatici rotanti - DOPPIO EFFETTO

IVR 175 - Butterfly valve LUG type - flanged ends PN16 + IVR 270 - Pneumatic rotary actuators - DOUBLE ACTING

IVR 175 - Ventil mit Flügelgriff aus Gusseisen Typ LUG - Flanschanschlüsse PN16 + IVR 270 - Rotierende Drehantriebe - DOPPELWIRKEND

IVR 175 - Vanne papillon en fonte type LUG - fixations bridées PN16 + IVR 270 - Actuateurs Pneumatiques tournants - DOUBLE EFFET

IVR 175 - Дисковый затвор Баттерфляй из чугуна - тип LUG - Фланцевое соединение PN16 + IVR 270 - Пневматические поворотные приводы - ДВОЙНОГО ДЕЙСТВИЯ

Cod./Code	Mod./Model	DN	□/田	€
417515604	IVR 175 DN 40 + AT63 DE	40	1	306,14
417520604	IVR 175 DN 50 + AT63 DE	50	1	296,16
417525607	IVR 175 DN 65 + AT63 DE	65	1	347,74
417530610	IVR 175 DN 80 + AT63 DE	80	1	373,89
417540611	IVR 175 DN 100 + AT83 DE	100	1	485,24
417550615	IVR 175 DN 125 + AT92 DE	125	1	690,90
417560615	IVR 175 DN 150 + AT105 DE	150	1	716,95





## IVR 176 + IVR 270



IVR 176 - Valvola a farfalla in ghisa tipo WAFER - attacchi flangiati PN16 + IVR 270 - Attuatori Pneumatici rotanti - DOPPIO EFFETTO

IVR 176 - Butterfly valve WAFER type - flanged ends PN16 + IVR 270 - Pneumatic rotary actuators - DOUBLE ACTING

IVR 176 - Ventil mit Flügelgriff aus Gusseisen Typ WAFER - Flanschanschlüsse PN16 + IVR 270 - Rotierende Drehantriebe - DOPPELWIRKEND

IVR 176 - Vanne papillon en fonte type WAFER - fixations bridées PN16 + IVR 270 - Actuateurs pneumatiques tournants - DOUBLE EFFET

IVR 176 - Дисковый затвор Баттерфляй из чугуна - тип WAFER - фланцевое соединение PN16 + IVR 270 - Пневматические поворотные приводы - ДВОЙНОГО ДЕЙСТВИЯ

Cod./Code	Mod./Model	DN	□/▣	€
417615604	IVR 176 DN 40 + AT63 DE	40	1	291,89
417620604	IVR 176 DN 50 + AT63 DE	50	1	294,74
417625607	IVR 176 DN 65 + AT63 DE	65	1	335,13
417630610	IVR 176 DN 80 + AT63 DE	80	1	365,44
417640611	IVR 176 DN 100 + AT83 DE	100	1	462,09
417650615	IVR 176 DN 125 + AT92 DE	125	1	650,72
417660617	IVR 176 DN 150 + AT105 DE	150	1	670,36
417680622	IVR 176 DN 200 + AT125 DE	200	1	962,63
417690626	IVR 176 DN 250 + AT140 DE	250	1	1.466,22
417695629	IVR 176 DN 300 + AT160 DE	300	1	2.242,30



## IVR 662 + IVR 271



IVR 662 - Valvola a sferain acciaio inox - attacchi F/F - flangia ISO 5211 + IVR 271 - Attuatore pneumatico rotante - SEMPLICE EFFETTO

IVR 662 - Ball valve in stainless steel - F/F - flange ISO 5211 + IVR 271 - Pneumatic rotary actuator - SPRING RETURN

IVR 662 - Kugelhahn aus rostfreiem Stahl AISI 316 - IG/IG - Flansche ISO 5211 + IVR 271 - Pneumatischer Drehantrieb - EINFACHWIRKEND

IVR 662 - Vanne à boisseau sphérique en acier inox AISI 316 - F/F - Bride ISO 5211 + IVR 271 - Actuateur pneumatique tournant - EFFET SIMPLE

Кран шаровой из нержавеющей стали - соединения В/В - фланец ISO 5211+ IVR 271 – Пневматический поворотный привод - ПРОСТОГО ДЕЙСТВИЯ

Cod./Code	Mod./Model	Mis./Size	□/▣	€
466202652	IVR 662 1/4" + AT52 SE	1/4"	1	231,22
466203652	IVR 662 3/8" + AT52 SE	3/8"	1	231,22
466205655	IVR 662 1/2" + AT52 SE	1/2"	1	254,56
466207656	IVR 662 3/4" + AT63 SE F04	3/4"	1	257,53
466210660	IVR 662 1" + AT63 SE	1"	1	301,33
466212660	IVR 662 1"1/4 + AT75 SE	1"1/4	1	355,14
466215665	IVR 662 1"1/2 + AT75 SE	1"1/2	1	390,19
466220665	IVR 662 2" + AT75 SE	2"	1	418,56
466225670	IVR 662 2"1/2 + AT105 SE	2"1/2	1	806,46
466230670	IVR 662 3" + AT125 SE	3"	1	880,12
466240672	IVR 662 4" + AT140 SE	4"	1	1.273,43



## IVR 665 + IVR 271



IVR 665 - Valvola a sfera in tre pezzi in acciaio inox - attacchi F/F - flangia ISO 5211 + IVR 271 - Attuatori Pneumatici rotanti - SEMPLICE EFFETTO

IVR 665 - Three-piece ball valve in stainless steel - threaded ends F/F - ISO 5211 flange + IVR 271 - Pneumatic rotary actuators - SPRING RETURN

IVR 665 - Kugelhahn, dreiteilig, aus Edelstahl - IG/IG - Flansch ISO 5211 + IVR 271 - Rotierende Drehantriebe - EINFACHWIRKEND

IVR 665 - Vanne à boisseau sphérique en trois pièces en acier inox - fixations F/F - bride ISO 5211 + IVR 271 - Actuateurs pneumatiques tournants - EFFET SIMPLE

IVR 665 - трёхсоставной шаровой кран из нержавеющей стали - соединения В/В - фланец ISO 5211 + IVR 271 - Пневматические поворотные приводы - ПРОСТОГО ДЕЙСТВИЯ

Cod./Code	Mod./Model	Mis./Size	□/▣	€
466502652	IVR 665 DN 1/4" + AT52 SE	1/4"	1	240,94
466503652	IVR 665 DN 3/8" + AT52 SE	3/8"	1	240,94
466505655	IVR 665 DN 1/2" + AT63 SE F04	1/2"	1/4	267,73
466507656	IVR 665 DN 3/4" + AT63 SE	3/4"	1	279,55
466510660	IVR 665 DN 1" + AT63 SE	1"	1	323,53
466512660	IVR 665 DN 1"1/4 + AT75 SE	1"1/4	1	387,58
466515665	IVR 665 DN 1"1/2 + AT75 SE	1"1/2	1	420,66
466520665	IVR 665 DN 2" + AT75 SE	2"	1	451,77
466525670	IVR 665 DN 2"1/2 + AT105 SE	2"1/2	1	898,67
466530670	IVR 665 DN 3" + AT125 SE	3"	1	1.041,28
466540672	IVR 665 DN 4" + AT140 SE	4"	1	1.438,61



## IVR 663 + IVR 271



IVR 663 - Valvola a sfera in tre pezzi in acciaio inox - attacchi F/F - flangia ISO 5211 + IVR 271 - Attuatore pneumatico rotante - SEMPLICE EFFETTO

IVR 663 - Three-piece full bore ball valve in stainless steel AISI 316 - F/F - ISO 5211 flange + IVR 271 - Pneumatic rotary actuator - SPRING RETURN

IVR 663 - Kugelhahn, dreiteilig, aus Edelstahl - IG/IG - Flansch ISO 5211 + IVR 271 - Rotierender Drehantrieb - EINFACHWIRKEND

IVR 663 - Vanne à boisseau sphérique en trois pièces en acier inox - F/F - bride ISO 5211 + IVR 271 - Actuateur pneumatique tournant - EFFET SIMPLE

IVR 663 - трёхсоставной шаровой кран из нержавеющей стали - соединения В/В - фланец ISO 5211 + IVR 271 - Пневматический поворотный привод - ПРОСТОГО ДЕЙСТВИЯ

Cod./Code	Mod./Model	Mis./Size	□/田	€
466305655	IVR 663 1/2" + AT52 SE	1/2"	1	269,47
466307656	IVR 663 3/4" + AT63 SE	3/4"	1	286,05
466310660	IVR 663 1" + AT63 SE	1"	1	335,52
466312660	IVR 663 1"1/4 + AT75 SE	1"1/4	1	416,51
466315665	IVR 663 1"1/2 + AT75 SE	1"1/2	1	471,29
466320665	IVR 663 2" + AT75 SE	2"	1	526,44
466325670	IVR 663 2"1/2 + AT105 SE	2"1/2	1	962,58
466330670	IVR 663 3" + AT125 SE	3"	1	1.091,97
466340672	IVR 663 4" + AT140 SE	4"	1	1.561,61



## IVR 670 + IVR 271



IVR 670 - Valvola a sfera in tre pezzi in acciaio inox - attacchi a saldare - flangia ISO 5211 + IVR 271 - Attuatori Pneumatici rotanti - SEMPLICE EFFETTO

IVR 670 - Three-piece ball valve in stainless steel- butt weld connections - ISO 5211 flange + IVR 271 - Pneumatic rotary actuators - SPRING RETURN

IVR 670 - Kugelhahn, dreiteilig, aus Edelstahl - Schweissenden - Flansch ISO 5211 + IVR 271 - Rotierende Drehantriebe - EINFACHWIRKEND

IVR 670 - Vanne à boisseau sphérique en trois pièces en acier inox - fixations à souder- bride ISO 5211 + IVR 271 - Actuateurs pneumatiques tournants - EFFET SIMPLE

IVR 670 - трёхсоставной шаровой кран - из нержавеющей стали - соединения под приварку - фланец ISO 5211+ IVR 271-Пневматические поворотные приводы - ПРОСТОГО ДЕЙСТВИЯ

Cod./Code	Mod./Model	Mis./Size	□/田	€
467002652	IVR 670 DN 1/4" + AT52 SE	1/4"	1	240,09
467003652	IVR 670 DN 3/8" + AT52 SE	3/8"	1	240,09
467005655	IVR 670 DN 1/2" + AT63 SE F04	1/2"	1	265,89
467007656	IVR 670 DN 3/4" + AT63 SE	3/4"	1	276,25
467010660	IVR 670 DN 1" + AT63 SE	1"	1	321,41
467012660	IVR 670 DN 1"1/4 + AT75 SE	1"1/4	1	339,34
467015665	IVR 670 DN 1"1/2 + AT75 SE	1"1/2	1	411,63
467020665	IVR 670 DN 2" + AT75 SE	2"	1	448,42
467025670	IVR 670 DN 2"1/2 + AT105 SE	2"1/2	1	892,01
467030670	IVR 670 DN 3" + AT125 SE	3"	1	1.031,65
467040672	IVR 670 DN 4" + AT140 SE	4"	1	1.423,11



## IVR 672 + IVR 271



IVR 672 - Valvola a sfera in tre pezzi in acciaio inox - attacchi a saldare di tasca - flangia ISO 5211 + IVR 271 - Attuatori Pneumatici rotanti - SEMPLICE EFFETTO

IVR 672 - Three-piece ball valve in stainless steel- socket weld connections - ISO 5211 flange + IVR 271 - Pneumatic rotary actuators - SPRING RETURN

IVR 672 - Kugelhahn, dreiteilig, aus Edelstahl - Schweißanschlüsse - Flansch ISO 5211 + IVR 271 - Rotierende Drehantriebe - EINFACHWIRKEND

IVR 672 - Vanne à boisseau sphérique en trois pièces en acier inox - fixations à souder de poche - bride ISO 5211 + IVR 271 - Actuateurs Pneumatiques tournants - EFFET SIMPLE

IVR 672 - трёхсоставной шаровой кран из нержавеющей стали - соединения под приварку - фланец ISO 5211 + IVR 271 - Пневматические приводы поворотные - ПРОСТОГО ДЕЙСТВИЯ

Cod./Code	Mod./Model	Mis./Size	□/田	€
467202652	IVR 672 DN 1/4" + AT52 SE	1/4"	1	241,76
467203652	IVR 672 DN 3/8" + AT52 SE	3/8"	1	241,76
467205655	IVR 672 DN 1/2" + AT63 SE F04	1/2"	1	267,54
467207656	IVR 672 DN 3/4" + AT63 SE	3/4"	1	278,76
467210660	IVR 672 DN 1" + AT63 SE	1"	1	324,32
467212660	IVR 672 DN 1"1/4 + AT75 SE	1"1/4	1	389,23
467215665	IVR 672 DN 1"1/2 + AT75 SE	1"1/2	1	417,46
467220665	IVR 672 DN 2" + AT75 SE	2"	1	456,35
467225670	IVR 672 DN 2"1/2 + AT105 SE	2"1/2	1	908,33
467230670	IVR 672 DN 3" + AT125 SE	3"	1	1.055,08
467240672	IVR 672 DN 4" + AT140 SE	4"	1	1.459,50



## IVR 144 L + IVR 271



IVR 144L - Valvola a sfera a passaggio ridotto a tre vie in acciaio inox AISI 316 - sfera forata a L - attacchi F/F/F - flangia ISO 5211 + IVR 271 - Attuatori Pneumatici rotanti - SEMPLICE EFFETTO

IVR 144L - 3-way reduce bore ball valve in stainless steel AISI 316 - bored ball as L - threaded ends F/F/F - ISO 5211 flange + IVR 271 - Pneumatic rotary actuators - SPRING RETURN

IVR 144L - 3-Wege-Kugelhahn mit reduziertem Durchgang aus Edelstahl AISI 316 - Kugel mit L-Bohrung - IG/IG/IG - Flansch ISO 5211 + IVR 271 - Rotierende Drehantriebe - EINFACHWIRKEND

IVR 144L - Vanne à boisseau sphérique à passage réduit à trois voies en acier inox AISI 316 - sphère percée en L - fixations F/F/F - bride ISO 521 + IVR 271 - Actuateurs pneumatiques tournants - EFFET SIMPLE

IVR 144L - трёхходовой шаровой кран из нержавеющей стали AISI 316 с редуцированным проходом - L-образный проход шара - соединения В/В/В - фланец ISO 5211 + IVR 271 - Пневматические поворотные приводы - ПРОСТОГО ДЕЙСТВИЯ

Cod./Code	Mod./Model	Mis./Size	□/田	€
414402652	IVR 144L 1/4" + AT52 SE	1/4"	1	298,53
414403652	IVR 144L 3/8" + AT52 SE	3/8"	1	298,53
414405652	IVR 144L 1/2" + AT52 SE	1/2"	1	298,53
414407656	IVR 144L 3/4" + AT63 SE	3/4"	1	323,46
414410656	IVR 144L 1" + AT75 SE	1"	1	416,57
414412660	IVR 144L 1"1/4 + AT83 SE	1"1/4	1	540,23
414415664	IVR 144L 1"1/2 + AT92 SE	1"1/2	1	623,93
414420667	IVR 144L 2" + AT105 SE	2"	1	919,19



## IVR 145 T + IVR 271



IVR 145T - Valvola a sfera a passaggio ridotto a tre vie in acciaio inox AISI 316 - sfera forata a T - attacchi F/F/F - flangia ISO 5211 + IVR 271 - Attuatori Pneumatici rotanti - SEMPLICE EFFETTO

IVR 145T - 3-way reduced bore ball valve in stainless steel AISI 316 - bored ball as T - threaded ends F/F/F - ISO 5211 flange + IVR 271 - Pneumatic rotary actuators - SPRING RETURN

IVR 145T - 3-Wege-Kugelhahn mit reduziertem Durchgang aus Edelstahl AISI 316 - Kugel mit T-Bohrung - IG/IG/IG - Flansch ISO 5211 + IVR 271 - Rotierende Drehantriebe - EINFACHWIRKEND

IVR 145T - Vanne à boisseau sphérique à passage réduit à trois voies en acier inox AISI 316 - sphère percée en T - fixations F/F/F - bride ISO 5211 + IVR 271 - Actuateurs pneumatiques tournants - EFFET SIMPLE

IVR 145T - трёхходовой шаровой кран из нержавеющей стали AISI 316 с редуцированным проходом - T-образный проход шара - соединения В/В/В - фланец ISO 5211 + IVR 271 - Пневматические поворотные приводы - ПРОСТОГО ДЕЙСТВИЯ

Cod./Code	Mod./Model	Mis./Size	□/田	€
414502652	IVR 145T 1/4" + AT52 SE	1/4"	1	298,53
414503652	IVR 145T 3/8" + AT52 SE	3/8"	1	298,53
414505652	IVR 145T 1/2" + AT52 SE	1/2"	1	298,53
414507656	IVR 145T 3/4" + AT63 SE	3/4"	1	323,46
414510656	IVR 145T 1" + AT75 SE	1"	1	416,17
414512660	IVR 145T 1"1/4 + AT83 SE	1"1/4	1	538,98
414515664	IVR 145T 1"1/2 + AT92 SE	1"1/2	1	622,27
414520667	IVR 145T 2" + AT105 SE	2"	1	914,17



## IVR 685 + IVR 271



IVR 685 - Valvola a sfera a corpo piatto flangiata in acciaio inox - flangia ISO 5211 - attacchi flangiati PN16 + IVR 271 - Attuatori Pneumatici rotanti - SEMPLICE EFFETTO

IVR 685 - WAFER flanged ball valve PN16 - stainless steel - ISO 5211 flange + IVR 271 - Pneumatic rotary actuators - SPRING RETURN

IVR 685 - Kugelhahn mit flachem, angeflanschtem Körper aus Edelstahl - Flansch ISO 5211 - Flanschanschlüsse PN16 + IVR 271 - Rotierende Drehantriebe - EINFACHWIRKEND

IVR 685 - Vanne à boisseau sphérique à corps plat bridée en acier inox - bride ISO 5211 - fixations bridées PN16 + IVR 271 - Actuateurs pneumatiques tournants - EFFET SIMPLE

IVR 685 - Шаровой кран с укороченным корпусом из нержавеющей стали - фланцевое соединение PN16 + IVR 271 - Пневматические поворотные приводы - ПРОСТОГО ДЕЙСТВИЯ

Cod./Code	Mod./Model	DN	□/田	€
468505652	IVR 685 DN 15 + AT52 SE	15	1	284,81
468507655	IVR 685 DN 20 + AT63 SE F04	20	1	324,87
468510660	IVR 685 DN 25 + AT63 SE	25	1	349,60
468512660	IVR 685 DN 32 + AT75 SE	32	1	437,68
468515665	IVR 685 DN 40 + AT83 SE	40	1	526,14
468520665	IVR 685 DN 50 + AT92 SE	50	1	627,79
468525672	IVR 685 DN 65 + AT140 SE	65	1	1.124,44
468530674	IVR 685 DN 80 + AT140 SE	80	1	1.648,59
468540676	IVR 685 DN 100 + AT160 SE	100	1	2.816,53



## IVR 664 + IVR 271



IVR 664 Valvola a sfera in due pezzi in acciaio inox AISI 316 - attacchi flangiati - flangia ISO 5211 + IVR 271 - SR - Attuatori Pneumatici rotanti - SEMPLICE EFFETTO

IVR 664 Two-piece ball valve in stainless steel AISI 316 - flanged connections - ISO 5211 flange + IVR 271 - SR - Pneumatic rotary actuators - SPRING RETURN

IVR 664 Zweiteiliger Kugelhahn aus rostfreiem Stahl AISI 316 mit Flanschanschlüssen - Flansche ISO 5211 + IVR 271 - SR - Rotierende Drehantriebe - EINFACHWIRKEND

IVR 664 Vanne à boisseau sphérique à deux pièces en acier inox AISI 316 - fixations bridées - bride ISO 5211 + IVR 271 - SR - Actuateurs pneumatiques tournants - EFFET SIMPLE

IVR 664 Двухсоставной полнопроходной шаровой кран из нержавеющей стали AISI 316 - фланцевые соединения - фланец ISO 5211+ IVR 271 – Пневматический поворотный привод - ПРОСТОГО ДЕЙСТВИЯ

Cod./Code	Mod./Model	DN	□/田	€
466405652	IVR 664 DN 15 + AT52 SE	15	1	310,12
466407655	IVR 664 DN 20 + AT63 SE F04	20	1	369,37
466410660	IVR 664 DN 25 + AT63 SE	25	1	414,05
466412660	IVR 664 DN 32 + AT75 SE	32	1	551,58
466415665	IVR 664 DN 40 + AT83 SE	40	1	641,51
466420665	IVR 664 DN 50 + AT92 SE	50	1	785,65
466425672	IVR 664 DN 65 + AT105 SE	65	1	1.395,90
466430674	IVR 664 DN 80 + AT125 SE	80	1	1.929,41
466440676	IVR 664 DN 100 + AT140 SE	100	1	3.051,81



## IVR 668 + IVR 271



IVR 668 Valvola a sfera in tre pezzi in acciaio inox AISI 316 - attacchi flangiati - flangia ISO 5211 + IVR 271 - SR - Attuatori Pneumatici rotanti - SEMPLICE EFFETTO

IVR 668 Three-piece ball valve in stainless steel AISI 316 - flanged connections - flange ISO 5211 + IVR 271 - SR - Pneumatic rotary actuators - SPRING RETURN

IVR 668 Kugelhahn dreiteilig aus Innoxstahl AISI 316 - mit geflanschten Gewinden - Flansche ISO 5211 + IVR 271 - SR - Rotierende Drehantriebe - EINFACHWIRKEND

IVR 668 Vanne à boisseau sphérique en trois pièces en acier inox AISI 316 - fixations bridées - bride ISO 5211 + IVR 271 - SR - Actuateurs pneumatiques tournants - EFFET SIMPLE

IVR 668 Трёхсоставной кран из нержавеющей стали AISI 316 - фланцевые соединения - фланец ISO 5211+ IVR 271 – Пневматический поворотный привод - ПРОСТОГО ДЕЙСТВИЯ

Cod./Code	Mod./Model	DN	□/田	€
466805652	IVR 668 DN 15 + AT52 SE	15	1	290,77
466807655	IVR 668 DN 20 + AT63 SE	20	1	354,89
466810660	IVR 668 DN 25 + AT63 SE	25	1	388,61
466812660	IVR 668 DN 32 + AT75 SE	32	1	526,80
466815665	IVR 668 DN 40 + AT83 SE	40	1	607,52
466820665	IVR 668 DN 50 + AT92 SE	50	1	745,28
466825672	IVR 668 DN 65 + AT105 SE	65	1	1.348,57
466830674	IVR 668 DN 80 + AT125 SE	80	1	1.909,25
466840676	IVR 668 DN 100 + AT140 SE	100	1	3.077,06



## IVR 77 + IVR 271



IVR 77 - Valvola flangiata in ghisa GJL 250 - attacchi flangiati PN16 + IVR 271 - Attuatori Pneumatici rotanti - SEMPLICE EFFETTO

IVR 77 - Cast iron GJL 250 ball valve - flanged ends PN16 + IVR 271 - Pneumatic rotary actuators - SPRING RETURN

IVR 77 - Flansch-Kugelhahn aus Gusseisen GJL 250 - Flanschanschlüsse PN16 + IVR 271 - Rotierende Drehantriebe - EINFACHWIRKEND

IVR 77 - Vanne bride en fonte GJL 250 - fixations bridées PN16 + IVR 271 - Actuateurs pneumatiques tournants - EFFET SIMPLE

IVR 77 - Шаровой кран из чугуна GJL 250 - Фланцевое соединение PN16 + IVR 271 - Пневматические поворотные приводы - ПРОСТОГО ДЕЙСТВИЯ

Cod./Code	Mod./Model	DN	□/田	€
407707659	IVR 77 DN 20 + AT63 SE F04	20	1	371,79
407710659	IVR 77 DN 25 + AT63 SE F04	25	1	393,93
407712663	IVR 77 DN 32 + AT63 SE F04	32	1	489,27
407715664	IVR 77 DN 40 + AT83 SE	40	1	492,12
407720666	IVR 77 DN 50 + AT83 SE	50	1	675,40
407725669	IVR 77 DN 65 + AT92 SE	65	1	632,55
407730669	IVR 77 DN 80 + AT125 SE	80	1	1.030,67
407740671	IVR 77 DN 100 + AT125 SE	100	1	1.125,15
407750674	IVR 77 DN 125 + AT140 SE	125	1	1.798,12
407760676	IVR 77 DN 150 + AT140 SE	150	1	2.026,58





## IVR 78 + IVR 271



IVR 78 - Valvola flangiata in ghisa GJL 250 - asta e sfera inox - attacchi flangiati PN16 + IVR 271 - Attuatori Pneumatici rotanti - SEMPLICE EFFETTO

IVR 78 - Cast iron GJL 250 ball valve - inox stem and ball - flanged ends PN16 + IVR 271 - Pneumatic rotary actuators - SPRING RETURN

IVR 78 - Flansch-Kugelhahn aus Gusseisen GJL 250 - Stab und Kugel aus Edelstahl - Flanschanschlüsse PN16 + IVR 271 - Rotierende Drehantriebe - EINFACHWIRKEND

IVR 78 - Vanne bride en fonte GJL 250 - tige et sphère inox - fixations bridées PN16 + IVR 271 - Actuateurs pneumatiques tournants - EFFET SIMPLE

IVR 78 - Шаровой кран из чугуна GJL 250 - шток и шар из нержавеющей стали - Фланцевое соединение PN16 + IVR 271 - Пневматические поворотные приводы - ПРОСТОГО ДЕЙСТВИЯ

Cod./Code	Mod./Model	DN	□/田	€
407807659	IVR 78 DN 20 + AT63 SE F04	20	1	368,38
407810659	IVR 78 DN 25 + AT63 SE F04	25	1	395,46
407812663	IVR 78 DN 32 + AT63 SE F04	32	1	514,23
407815664	IVR 78 DN 40 + AT83 SE	40	1	537,83
407820666	IVR 78 DN 50 + AT83 SE	50	1	594,01
407825669	IVR 78 DN 65 + AT92 SE	65	1	825,18
407830669	IVR 78 DN 80 + AT125 SE	80	1	1.127,96
407840671	IVR 78 DN 100 + AT125 SE	100	1	1.159,02
407850674	IVR 78 DN 125 + AT140 SE	125	1	1.991,31
407860676	IVR 78 DN 150 + AT140 SE	150	1	2.461,81



## IVR 276 CF8M + IVR 271



IVR 276 CF8M - Valvola a farfalla in ghisa tipo WAFER - disco inox - attacchi flangiati PN16 + IVR 271 - Attuatori Pneumatici rotanti - SEMPLICE EFFETTO

IVR 276 CF8M - Butterfly valve WAFER type - stainless steel disc - flanged ends PN16 + IVR 271 - Pneumatic rotary actuators - SPRING RETURN

IVR 276 CF8M - Ventil mit Flügelgriff aus Gusseisen Typ WAFER - Edstahlscheibe - Flanschanschlüsse PN16 + IVR 271 - Rotierende Drehantriebe - EINFACHWIRKEND

IVR 276 CF8M - Vanne papillon en fonte type WAFER - disque inox - fixations bridées PN16 + IVR 271 - Actuateurs pneumatiques tournants - EFFET SIMPLE

IVR 276 CF8M - Дисковый затвор Баттерфляй из чугуна - тип WAFER - диск из нержавеющей стали - Фланцевое соединение PN 16 + IVR 271 - Пневматические поворотные приводы - ПРОСТОГО ДЕЙСТВИЯ

Cod./Code	Mod./Model	DN	□/田	€
427615660	IVR 276 CF8M DN 40 + AT63 SE	40	1	427,06
427620660	IVR 276 CF8M DN 50 + AT75 SE	50	1	467,00
427625660	IVR 276 CF8M DN 65 + AT83 SE	65	1	527,02
427630664	IVR 276 CF8M DN 80 + AT92 SE	80	1	711,56
427640667	IVR 276 CF8M DN 100 + AT105 SE	100	1	795,51
427650669	IVR 276 CF8M DN 125 + AT125 SE	125	1	1.060,44
427660671	IVR 276 CF8M DN 150 + AT140 SE	150	1	1.499,43
427680676	IVR 276 CF8M DN 200 + AT160 SE	200	1	2.572,15
427690678	IVR 276 CF8M DN 250 + AT190 SE	250	1	5.625,08
427695681	IVR 276 CF8M DN 300 + AT210 SE	300	1	6.469,74



## IVR 175 + IVR 271



IVR 175 - Valvola a farfalla in ghisa tipo LUG - attacchi flangiati PN16 + IVR 271 - Attuatori Pneumatici rotanti - SEMPLICE EFFETTO

IVR 175 - Butterfly valve LUG type - flanged ends PN16 + IVR 271 - Pneumatic rotary actuators - SPRING RETURN

IVR 175 - Ventil mit Flügelgriff aus Gusseisen Typ LUG - Flanschanschlüsse PN16 IVR 271 - Actuateurs IVR + IVR 271 - Rotierende Drehantriebe - EINFACHWIRKEND

IVR 175 - Vanne papillon en fonte type LUG - fixations bridées PN16 + IVR 271 - Actuateurs pneumatiques tournants - EFFET SIMPLE

IVR 175 - Дисковый затвор Баттерфляй из чугуна - тип LUG - Фланцевое соединение PN16 + IVR 271 - Пневматические поворотные приводы - ПРОСТОГО ДЕЙСТВИЯ

Cod./Code	Mod./Model	DN	□/田	€
417515660	IVR 175 DN 40 + AT63 SE	40	1	414,52
417520660	IVR 175 DN 50 + AT75 SE	50	1	453,71
417525660	IVR 175 DN 65 + AT83 SE	65	1	505,79
417530664	IVR 175 DN 80 + AT92 SE	80	1	685,92
417540667	IVR 175 DN 100 + AT105 SE	100	1	758,43
417550669	IVR 175 DN 125 + AT125 SE	125	1	997,97



## IVR 176 + IVR 271



EAC CE

IVR 176 -Valvola a farfalla in ghisa tipo WAFER - attacchi flangiati PN16 + IVR 271 - Attuatori Pneumatici rotanti - SEMPLICE EFFETTO

IVR 176 - Butterfly valve WAFER type - flanged ends PN16 + IVR 271 - Pneumatic rotary actuators - SPRING RETURN

IVR 176 -Ventil mit Flügelgriff aus Gusseisen Typ WAFER - Flanschanschlüsse PN16 + IVR 271 - Rotierende Drehantriebe - EINFACHWIRKEND

IVR 176 -Vanne papillon en fonte type WAFER - fixations bridées PN16 + IVR 271 - Actuateurs pneumatiques tournants - EFFET SIMPLE

IVR 176 -Дисковый затвор Баттерфляй из чугуна - тип WAFER - Фланцевое соединение PN16 + IVR 271 - Пневматические поворотные приводы - ПРОСТОГО ДЕЙСТВИЯ

Cod./Code	Mod./Model	DN	□/田	€
417615660	IVR 176 DN 40 + AT63 SE	40	1	396,11
417620660	IVR 176 DN 50 + AT75 SE	50	1	433,69
417625660	IVR 176 DN 65 + AT83 SE	65	1	487,10
417630664	IVR 176 DN 80 + AT92 SE	80	1	657,70
417640667	IVR 176 DN 100 + AT105 SE	100	1	735,30
417650669	IVR 176 DN 125 + AT125 SE	125	1	945,98
417660671	IVR 176 DN 150 + AT140 SE	150	1	1.335,30
417680676	IVR 176 DN 200 + AT160 SE	200	1	2.291,31
417690678	IVR 176 DN 250 + AT190 SE	250	1	3.064,15
417695681	IVR 176 DN 300 + AT210 SE	300	1	5.616,13



## IVR 270

NEW



EAC

IVR 270 - DA - Attuatori Pneumatici rotanti - DOPPIO EFFETTO

IVR 270 - DA - Pneumatic rotary actuators - DOUBLE ACTING

IVR 270 - DA - Rotierende Drehantriebe - DOPPELWIRKEND

IVR 270 - DA - Actuateurs pneumatiques tournants - DOUBLE EFFET

IVR 270 - DA - Пневматические поворотные приводы - ДВОЙНОГО ДЕЙСТВИЯ

Cod./Code	Mod./Model	□/田	€
127004305	ATT PNEU DE AT40 F03/F05 Q.11	1	108,53
127005004	ATT PNEU DE AT52 F04 Q.11	1	123,97
127005305	ATT PNEU DE AT52 F03/F05 Q.11	1	123,97
127006004	ATT PNEU DE AT63 F04 Q.14	1	149,70
127006507	ATT PNEU DE AT63 F05/F07 Q.14	1	149,70
127007507	ATT PNEU DE AT75 F05/F07 Q.14	1	196,01
127008507	ATT PNEU DE AT83 F05/F07 Q.17	1	232,04
127009507	ATT PNEU DE AT92 F05/F07 Q.17	1	262,92
127010710	ATT PNEU DE AT105 F07/F10 Q.22	1	381,28
127012710	ATT PNEU DE AT125 F07/F10 Q.22	1	422,45
127014112	ATT PNEU DE AT140 F10/F12 Q.27	1	592,27
127016112	ATT PNEU DE AT160 F10/F12 Q.27	1	967,95



## IVR 271

NEW



EAC

IVR 271 - SR - Attuatori Pneumatici rotanti - SEMPLICE EFFETTO

IVR 271 - SR - Pneumatic rotary actuators - SPRING RETURN

IVR 271 - SR - Rotierende Drehantriebe - EINFACHWIRKEND

IVR 271 - SR - Actuateurs pneumatiques tournants - EFFET SIMPLE

IVR 271 - SR - Пневматические поворотные приводы - ПРОСТОГО ДЕЙСТВИЯ

Cod./Code	Mod./Model	□/田	€
127105305	ATT PNEU SE AT52 F03/F05 Q.11	1	155,87
127106004	ATT PNEU SE AT63 F04 Q.14	1	204,26
127106507	ATT PNEU SE AT63 F05/F07 Q.14	1	204,26
127107507	ATT PNEU SE AT75 F05/F07 Q.14	1	259,83
127108507	ATT PNEU SE AT83 F05/F07 Q.17	1	296,88
127109507	ATT PNEU SE AT92 F05/F07 Q.17	1	343,21
127110710	ATT PNEU SE AT105 F07/F10 Q.22	1	463,62
127112710	ATT PNEU SE AT125 F07/F10 Q.22	1	643,74
127114112	ATT PNEU SE AT140 F10/F12 Q.27	1	720,93
127116112	ATT PNEU SE AT160 F10/F12 Q.27	1	1.338,48
127119014	ATT PNEU SE AT190 F14 Q.36	1	1.750,17
127121014	ATT PNEU SE AT210 F14 Q.36	1	2.316,26





## ACCESSORI PER ATTUATORI INDUSTRIALI ACCESSORIES FOR INDUSTRIAL ACTUATORS

### IVR 795



Riduzioni quadre per attuatori pneumatici ed elettrici - Se si acquistano i prodotti non montati e/o componenti, siete pregati di leggere attentamente le istruzioni

Square adapters for pneumatic actuators - If you require our products not-assembled and/or just the components, please read the instructions

Eckförmige Minderer für pneumatische Antriebe MHP-DA / SR - bitte lesen Sie das Schema, wenn Sie die nicht montierte Produkte und/oder nur die Bestandteile einkaufen möchten

Réductions quadre pour actuateurs pneumatiques - MHP-DA / SR - Si on veut acheter les produits pas assemblés et/ou seulement les composants, lisez-Vous s'il Vous plaît les instructions

Квадратные адаптеры для пневмоприводов - MHP-DA / SR - при заказе продукции в разборе и/или запчастей просим читать инструкцию

Cod./Code	□/田	€
504309111	10/180	7,94
504309141	10/180	15,88
504311141	10/180	9,92
504311171	10/180	16,87
504314171	10/180	12,89
504317221	10/180	18,86
504322271	10/180	24,32
504327361	10/180	96,77

### IVR 796



**ERC**

Box micro 3 fili - tipo meccanico - IP 66

Limit switch box - mechanical type - IP66

Gehäuse Mikroschalter - mechanischer Typ - IP 66

Box micro - type mécanique - IP66

Блок микровыключателей - механического типа - IP66

Cod./Code	Mod./Model	□/田	€
505401001	APL-210N	1/8	120,87



### IVR 797



**ERC**

Elettrovalvole a singolo o doppio solenoide NAMUR - per attuatori pneumatici a doppio o semplice effetto (110 V disponibile su richiesta)

Single or double solenoid valves NAMUR - for double or single acting pneumatic actuators (110 V available on request)

Einzel- oder Doppelmagnetventile NAMUR - für doppelt- oder einfachwirkende pneumatische Antriebe (110 V auf Anfrage erhältlich)

Electrovannes simples ou doubles NAMUR - pour actionneurs pneumatiques double ou simple effet (110 V disponible sur demande)

Одинарные или двойные электромагнитные клапаны NAMUR - для пневматических приводов двойного или одностороннего действия (110 В по запросу)

Cod./Code	Mod./Model	Mis./Size	□/田	€
179702051	3/5 vie 1sol. 24V DC	1/4"	2/24	102,30
179702052	5 vie 2sol. 24V DC	1/4"	2/24	149,18
179702251	3/5 vie 1sol. 230V AC	1/4"	2/24	102,30
179702252	5 vie 2sol. 230V AC	1/4"	2/24	149,18



## RICAMBI LINEA INDUSTRIA SPARE PARTS FOR INDUSTRIAL LINE

### IVR LEVA ACCIAIO NERA ART 77-78



Leva nera in acciaio per IVR 77 78  
Black handle in steel for IVR 77 78  
Schwarzer Hebelgriff aus Stahl IVR 77 78  
Poignée noire en acier pour IVR 77 78  
Стальная ручка черного цвета для IVR 77 - 78

Cod./Code	Mod./Model	□/⊞	€
229080400	7a MIS A	1	27,26
702022001	G/2	100	2,50
702032001	G/3	50	3,34
702052001	G/5	30	5,29
702062001	G/6	10	16,91

### IVR LEVA IMBUTITA ROSSA



Leva imbutita rossa per valvole IVR 80 81  
Red steel drawn handle for valves IVR 80 81  
Roter tiefgezogener Hebelgriff aus Stahl für Kugelhähne IVR 80 81  
Poignée rouge emboutie en acier pour vannes IVR 80 81  
Красная штампованная стальная ручка для IVR 80 81

Cod./Code	Mod./Model	□/⊞	€
701031501	3a MIS A	10/60	2,71
701041501	4a MIS A	10/40	7,05
701051501	5a MIS A	5/20	8,81

### IVR LEVA NERA WAFER LUG



Leva nera per valvole tipo Wafer  
Black handle for valves type Wafer  
Schwarzer Hebelgriff für Kugelhähne Typ Wafer  
Poignée noire pour vannes type Wafer  
Ручка чёрного цвета для клапанов модели WAFER

Cod./Code	Mod./Model	□/⊞	€
702320151	per DN 40-50	10	15,28
702320251	per DN 65-80	10	15,28
702320401	per DN 100	10	15,28
702320501	per DN 125-150	10	15,28
702320801	per DN 200	5	27,50
702320901	per DN 250-300	5	40,07

### IVR 172 C



Cestello inox per filtro a Y in ghisa (per IVR 172)  
Screen for Y strainer in stainless steel (for IVR 172 )  
Edelstahlkäfig für Y-förmigen Filter aus Gusseisen (für IVR 172)  
Panier inox pour filtre en Y en fonte (pour IVR 172)  
Сетка из нержавеющей стали для Y-образного фильтра из чугуна (для IVR 172)

Cod./Code	Mod./Model	□/⊞	€
334142201	per DN 50	20	7,85
334142251	per DN 65	15	12,45
334142301	per DN 80	10	16,08
334142401	per DN 100	1	22,25
334142501	per DN 125	1	29,64
334142601	per DN 150	1	50,38
334142801	per DN 200	1	76,19
334142901	per DN 250	1	146,35
334142951	per DN 250	1	187,86

## IVR 172 G



Guarnizione o-ring per vite spurgo e coperchio filtro a Y in ghisa (per IVR 172)

O-ring for drain bolt and bonnet for Y strainer (for IVR 172)

O-Ring für Ablassschraube und Deckel für Y-Filter aus Gusseisen (für IVR 172)

Joint O-ring pour vis de purge et couvercle de filtre en Y en fonte (pour IVR 172)

Уплотнительное О - кольцо для дренажного болта и крышки Y-образного фильтра из чугуна (для IVR 172)

Cod./Code	Mod./Model	□/田	€
334143021	per DN 50-80 - spurgo 18x2,4	50/200	0,27
334143041	per DN 100-300 - spurgo 24x3,1	50/200	0,40
334143201	per DN 50 - coperchio 75x4,0	50/200	1,20
334143251	per DN 65 - coperchio 90x4,0	50/200	1,46
334143301	per DN 80 - coperchio 110x4,0	50/200	1,68
334143401	per DN 100 - coperchio 130x5,7	50/200	1,94
334143501	per DN 125 - coperchio 150x5,7	50/200	2,38
334143601	per DN 150 - coperchio 180x5,7	50/200	2,76
334143801	per DN 200 - coperchio 215x5,7	50/200	3,30
334143901	per DN 250 - coperchio 310x5,7	50/200	4,21
334143951	per DN 300 - coperchio 350x5,7	50/200	4,70

## IVR GUA 77/78



Kit guarnizioni di ricambio per valvola a sfera in ghisa IVR 77 78

Set of washer spare parts for cast iron ball valves IVR 77 78

Garnitur von Ersatzdichtungen für Kugelhähne aus Gusseisen IVR 77 78

Kit de joints de rechange pour vannes à boisseau sphérique en fonte IVR 77 78

Комплект сменных прокладок для чугунного крана IVR 77 78

Cod./Code	Mod./Model	□/田	€
334205071	Per DN 20	10/120	5,45
334205101	Per DN 25	10/120	6,03
334205121	Per DN 32	10/120	6,77
334205151	Per DN 40	10/120	7,95
334205201	Per DN 50	5/50	7,92
334205251	Per DN 65	5/50	12,48
334205301	Per DN 80	5/50	22,73
334205401	Per DN100	5/50	22,57
334205501	Per DN125	1/4	83,78
334205601	Per DN150	1/4	136,90
334205801	Per DN200	1/4	198,57

## IVR GUA 80/81



Kit di guarnizioni di ricambio per valvola sfera a corpo piatto in ghisa IVR 80 81

Kit of washer spare parts for ball valve in cast iron IVR 80 81

Garnitur von Ersatzdichtungen für Kugelhähne aus Gusseisen IVR 80 81

Kit de joints de rechange pour vannes à boisseau sphérique en fonte IVR 80 81

Комплект сменных прокладок для крана с укороченным корпусом из чугуна для IVR 80 - 81

Cod./Code	Mod./Model	□/田	€
334207121	Per DN 32	10/120	5,92
334207151	Per DN 40	10/120	5,54
334207201	Per DN 50	5/50	5,43
334207251	Per DN 65	5/50	9,52
334207301	Per DN 80	5/50	15,38
334207401	Per DN100	5/50	22,06





**VALVOLE INDUSTRIALI**  
INDUSTRIAL VALVES  
INDUSTRIEKUGELHÄHNE UND VENTILE  
VANNES INDUSTRIE  
ИНДУСТРИАЛЬНАЯ ЗАПОРНАЯ АРМАТУРА





**blossom-ic**  
intelligent controls

**DOMOTICA SMART**  
SMART HOME AUTOMATION  
SMART-HOME-AUTOMATISIERUNG  
DOMOTIQUE INTELLIGENTE  
УМНАЯ ДОМАШНЯЯ АВТОМАТИЗАЦИЯ



## • Il bilanciamento idraulico diventa digitale •

### Bilanciamento idraulico in soli 3 passaggi

1. Connettiti al Gateway
  2. Posiziona i termostati blossom-ic sulle valvole del radiatore
  3. Registra i termostati sul gateway (il sistema regola l'impianto di riscaldamento)
- Bilanciamento idraulico digitale e controllo intelligente del riscaldamento domestico in un unico prodotto

Con il nostro processo certificato TÜV, il bilanciamento idraulico diventa un gioco da ragazzi. Potrai risparmiare sui costi per gli interventi di installazione sulle tubazioni e sul montaggio delle valvole pre-regolabili. Sostituisci in maniera semplice e rapida le testine termostatiche presenti sui radiatori con gli attuatori blossom-ic e regISTRALI sul gateway blossom-ic. Se il gateway è collegato al router, è possibile eseguire tutte le impostazioni tramite l'App dedicata

D'ora in poi per i sistemi esistenti non perderai più tempo prezioso per il calcolo del fabbisogno termico. Grazie al software intelligente, durante le fasi successive di riscaldamento il nostro gateway rileverà automaticamente il bilanciamento idraulico. Se, per una modifica delle disposizioni costruttive ai fini dell'efficienza energetica il fabbisogno termico varia, il sistema si regola immediatamente in base ai nuovi criteri. Il sistema reagisce inoltre in maniera dinamica all'inserimento di nuovi parametri della temperatura garantendo una distribuzione del calore costante e uniforme

### Esempio di impianto di riscaldamento non bilanciato

Il flusso d'acqua cerca il percorso che è superabile con il minimo sforzo. In base a questo principio, l'acqua di riscaldamento torna alla caldaia il più rapidamente possibile. Il risultato è che le stanze più lontane dal centro di riscaldamento, come l'attico ad esempio, non vengono riscaldate correttamente. Diversamente, le stanze più vicine alla caldaia si surriscaldano.

- Inefficienza del sistema di riscaldamento - costi di riscaldamento elevati
- Basso comfort abitativo - stanze molto fredde
- Dannoso per l'ambiente
- Rumorosità del flusso che scorre sui radiatori

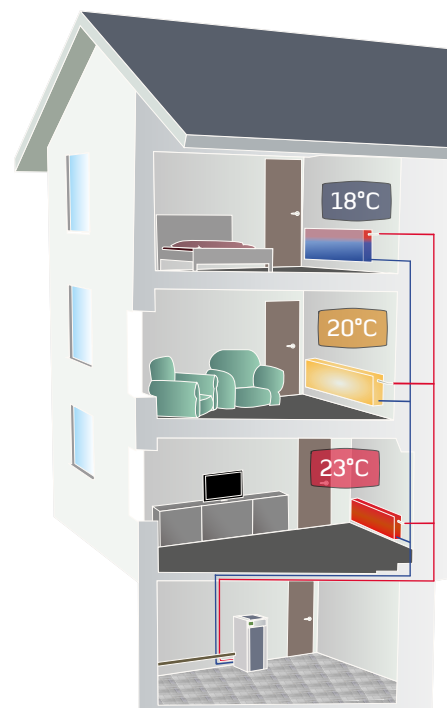



## • Il bilanciamento idraulico diventa digitale •

Con la sua tecnologia innovativa blossom-ic stabilisce un nuovo standard!

I termostati per termosifoni della serie Avalon regolano in maniera autonoma e automatica le valvole sui radiatori secondo l'algoritmo blossom-ic.

In caso di variazioni sugli ambienti o sul sistema di riscaldamento, utilizzando il bilanciamento idraulico statico convenzionale, occorre eseguire un nuovo bilanciamento idraulico. Il sistema blossom-ic invece è in grado di riconoscere autonomamente questo cambiamento garantendo un riscaldamento uniforme in pochissimo tempo. Grazie agli algoritmi intelligenti, il sistema blossom-ic si regola in base ai singoli ambienti garantendo un calcolo privo di errori.

I termostati vengono calibrati a intervalli regolari, evitando il bloccaggio dei vitoni delle valvole. Questo risulta particolarmente utile nei mesi estivi e autunnali. Nei sistemi convenzionali, i vitoni delle valvole termostatiche rimangono nella stessa posizione per l'intero periodo bloccandosi frequentemente.

Scegliendo il nostro sistema blossom-ic potrai controllare il tuo sistema di riscaldamento sfruttando il bilanciamento idraulico digitale dinamico combinato con il sistema di controllo radio intelligente, con funzioni espandibili per la gestione tecnica della tua casa. In linea generale, i componenti blossom-ic vengono utilizzati nei nuovi sistemi, nelle ristrutturazioni e negli ampliamenti degli impianti esistenti in quanto offrono un ottimo rapporto costi/benefici.

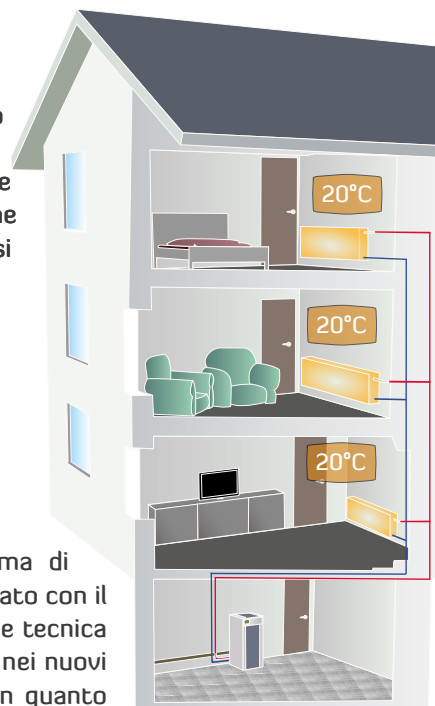

### Bilanciamento idraulico dinamico digitale basato su algoritmi intelligenti

- ✓ Metodo unico: completamente automatico, autonomo e adattivo
- ✓ Per impianti di riscaldamento a tubazione singola o doppia
- ✓ Nessun calcolo complesso
- ✓ Facilità di montaggio: tempi di assemblaggio molto brevi
- ✓ Non è necessario alcun intervento sulla rete idraulica e sulle tubature esistenti
- ✓ Nessun riempimento e svuotamento del sistema
- ✓ Non è necessaria la sostituzione delle sottosezioni della valvola termostatica
- ✓ Non sono necessarie valvole preimpostate
- ✓ Fino al 30% di risparmio energetico
- ✓ Certificazione TUV

**dhb**  
digital-hydraulic-balance

## La famiglia di termostati blossom-ic

La possibilità di combinare molteplici configurazioni e l'ottimizzazione economica del sistema di riscaldamento sono le caratteristiche principali dei nostri termostati. L'interazione tra l'app ibrida e l'esclusiva tecnica del sensore consentono di raggiungere il comfort desiderato nel rispetto del risparmio energetico

**Riscaldare in maniera SOSTENIBILE e SENZA DANNEGGIARE L'AMBIENTE, risparmiando contemporaneamente TEMPO e DENARO!**

- Tecnologia con touchpad e touchscreen
- Sensori di movimento su tutti i termostati
- Alta qualità combinata con un design moderno
- Tecnologia radio unica e innovativa blossom-ic
- Tecnologia intelligente, indipendente



### Siamo... pronti per il Futuro e tu?

La combinazione tra app e termostati del sensore consente un controllo preciso del riscaldamento con il massimo comfort ed il massimo risparmio.

I sensori sensibili rilevano i movimenti delle persone nelle stanze. Di conseguenza, avviene automaticamente la regolazione dei programmi/periodi di riscaldamento.



## Guadagni comfort e riduci i costi!

Molto semplice, con lo Smartphone e l'app blossom-ic, sarà possibile controllare i radiatori, il riscaldamento a pavimento, le caldaie ed i singoli piani in maniera consapevole dal punto di vista energetico ed economicamente conveniente. Che si tratti di una casa unifamiliare o multifamiliare, di un ufficio o di un edificio pubblico, renderete il vostro impianto di riscaldamento pronto per il futuro.



## Sentiti sicuro!

Il Gateway GT-100 è il cuore del sistema di controllo. La SICUREZZA è la nostra massima priorità. Con noi non esiste registrazione e controllo tramite portale internet! Con la tecnologia blossom-ic, sei nella rete protetta della tua casa. Gli aggiornamenti completamente automatici garantiscono di avere un sistema sempre all'avanguardia. Di conseguenza il vostro gateway è compatibile anche con le innovazioni future.



## Installazione più semplice

blossom-ic significa anche collegamenti plug and play. L'installazione è molto semplice. Non è necessario scaricare driver o software di installazione o eseguire una configurazione tramite computer. Guarda tu stesso:

Video ed istruzioni di installazione su: [www.blossomic.it](http://www.blossomic.it)





*controllo completo disponibile in diverse lingue*



# Benvenuto a casa!

## Controllate i vostri sistemi di riscaldamento con la famiglia di prodotti<sup>+</sup> blossom-ic





-  Gestibile tramite l'app blossom-ic
-  Controllo tramite sensore integrato
-  Prodotto con bilanciamento idraulico



## Controllo dei radiatori

1  **Avalon+**  
Termostato radiatore

2  **Avalon Combo+**  
Termostato ambiente e attuatore radio per il controllo dei radiatori schermati da tende o copri termo

3  **Tarus String**  
Unità di controllo per regolare i sistemi di riscaldamento a tubazione singola



8  **Gateway**  
Unità di controllo centrale internet Gateway GT-100 con tecnologia radio blossom-ic e app



## Controllo riscaldamento a pavimento

4  **Hera Direct+**  
Termostato ambiente SUPERIORE per controllare il riscaldamento a pavimento in combinazione con le barre radio. Può essere utilizzato anche con attuatori convenzionali (direttamente cablato)

5  **Hera+**  
Termostato ambiente radio per controllare il riscaldamento a pavimento in combinazione con le barre radio

6  **Hera+ Primus/Extensia PRO**  
Barra radio per controllare il riscaldamento a collettore (modulo a 6 zone)

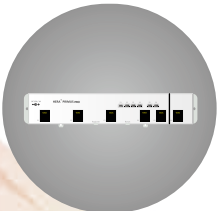

7  **Hera+ Actor**  
Attuatore per controllare il riscaldamento a collettore



8  **Gateway**  
Unità di controllo centrale internet Gateway GT-100 con tecnologia radio blossom-ic e app



9  **IVR 803 Kit S**  
Collettore premontato in acciaio AISI 304 diametro 1" con uscite 3/4"EK ad interasse 50 mm



 Per maggiori informazioni sul prodotto con bilanciamento idraulico, consultare pagina 2 e 3





## IVR 569 - Valvola per radiatore



Valvola termostattizzabile a squadra, attacco PEX, multistrato e tubo rame, bocchettone con autotenuta, nichelata, con cappello di regolazione.

Cod./Code	Mis./Size	Att./Conn.
156905160	1/2"	1/2"
156905180	1/2"	24-19

## IVR 557 - Detentore per radiatore



Detentore a squadra, attacco PEX, multistrato e tubo rame, bocchettone con autotenuta, nichelato.

Cod./Code	Mis./Size	Att./Conn.
155705160	1/2"	1/2"
155705180	1/2"	24-19

## Avalon<sup>+</sup> Tres Set

N. art. B-APTS-3980



Termostati radiatore  
Tecnologia radio blossom-ic e app.  
Attacco 30x1,5 predisposto per termostati blossom-ic.

Fornitura:  
3 termostati Avalon<sup>+</sup> incluse batterie  
1 Gateway GT-100 con accessori di collegamento 230 V



## Avalon Combo<sup>+</sup>

N. art. B-ACSE-3979



Termostato ambiente e attuatore radio per il controllo dei radiatori schermati da tende o copritermo. Può essere usato anche come termostato head+ con sensore remoto. Con un termostato ambiente radio, è possibile controllare contemporaneamente 5 attuatori.

Tecnologia radio blossomic-ic e app.

Attacco 30x1,5 predisposto per termostati blossomic-ic.

Fornitura:

1 termostato ambiente radio Avalon Combo<sup>+</sup> incluse batterie

1 attuatore Avalon Combo<sup>+</sup> incluse batterie



Grazie a blossomic-ic, ti sveglierai ogni mattina in un ambiente caldo e accogliente.



## Hera<sup>+</sup> Primus PRO Tres Set

N. art. B-HPPS-4070

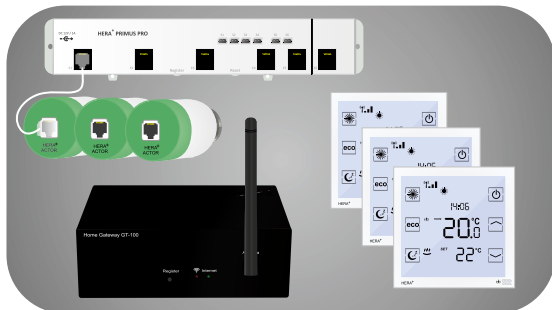

Termostato ambiente radio in combinazione con la barra di riscaldamento a collettore radio e gli attuatori, per controllo ambiente singolo (modulo a 6 zone). Tecnologia radio blossom-ic e app.

Fornitura:

- 3 termostati ambiente radio Hera<sup>+</sup> include batterie
- 1 barra radio Hera<sup>+</sup> Primus Pro  
230 V (modulo a 6 zone)
- 3 Hera<sup>+</sup> Actor con jack RJ 11 0.85m
- 1 Gateway GT-100 con accessori di collegamento 230 V

## IVR 803 Kit S



Collettore premontato in acciaio AISI 304 diametro 1" con uscite 3/4"EK ad interasse 50 mm composto da:

- collettore di mandata con detentore micrometrico di intercettazione per ogni singolo circuito, valvola di sfato aria manuale e valvola di carico/scarico acqua
- collettore di ritorno con attuatore radio per ogni singolo circuito, valvola di sfato aria e valvola di carico/scarico acqua
- coppia di valvole a sfera a bocchettone con termometro 0-80° e tappi diametro 1"
- barra radio per collegamento attuatori escluso cassette di contenimento
- sensori di temperatura





## Magelan Set

N. art. B-AS-3555



Sistema di controllo caldaia con termostato ambiente radio per controllare sistemi caldaia semplici o con compensazione climatica Tecnologia radio blossom-ic e app.

Fornitura:

- 1 sistemi di controllo caldaia Magelan 230 V
- 1 termostati ambiente radio Magelan incluse batterie
- 1 Gateway GT-100 con accessori di collegamento 230 V

## Magelan Combo Set

N. art. B-ACS-3556



Termostato ambiente con sistema di controllo caldaia integrato per il controllo di sistemi di caldaia semplici o regolati in base all'ambiente (cablati direttamente), con tecnologia radio blossom-ic e app.

Fornitura:

- 1 termostato Magelan Combo 230 V
- 1 Gateway GT-100 con accessori di collegamento 230 V





## Tarus Set

N. art. B-TS-3554



Unità di controllo per regolare i piani o gli appartamenti in case multifamiliari. Installazione nel tubo di mandata con sezione inferiore della valvola Tarus inclusa nella fornitura. Tecnologia radio blossom-ic e app.

Fornitura:

- 1 termostati Taurus incluse batterie
- 1 unità di controllo Tarus 230 V
- 1 valvola Tarus con filettatura esterna 1"
- 1 Gateway GT-100 con accessori di collegamento 230 V

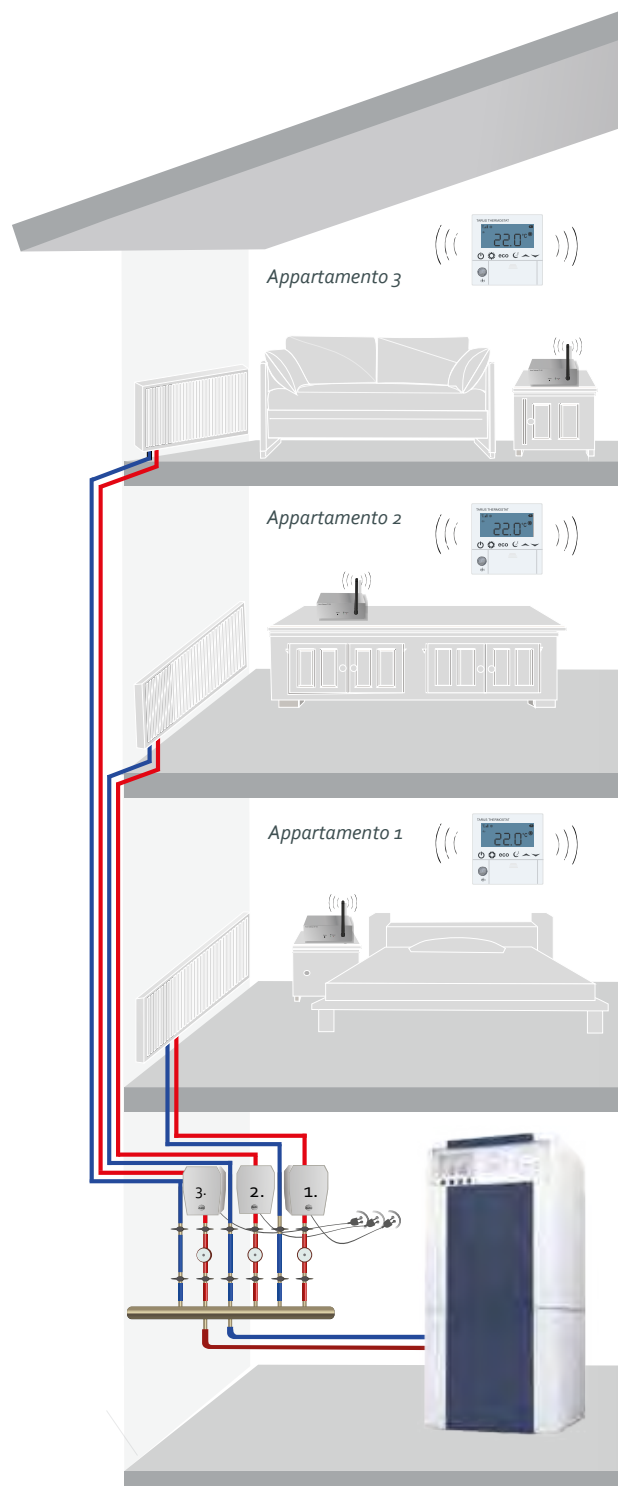



## Tarus String

N. art. B-TST-3748



Centralina per controllo riscaldamento a tubazione singola Installazione nella linea di flusso con sottosezione valvola Tarus inclusa. Tecnologia radio blossom-ic e app.

La fornitura comprende:  
1x centralina Tarus String  
1x valvola Tarus 1"AG

Combinabile con i seguenti articoli:



Esempio di utilizzo:

L'unità di controllo Tarus String viene installata nella linea di flusso dell'impianto di riscaldamento impedendo la circolazione forzata in assenza di richiesta di calore.

In ogni caso il sistema Tarus String non influisce sul bilanciamento idraulico. L'installazione è facoltativa.

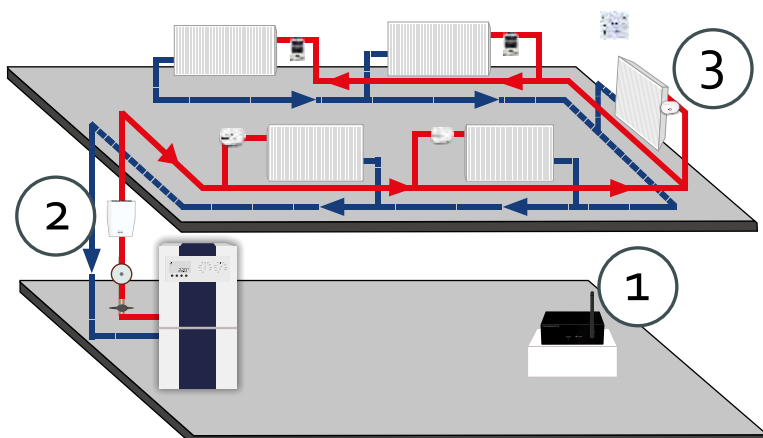

- ① Gateway GT-100 (nero)
- ② Centralina Tarus String
- ③ Termostato per radiatore serie AVALON





nero  
GS-3996



## Dati tecnici

### Gateway GT-100 - unità di controllo centrale

• Interfaccia	TCP/IP 10/100M, RJ45
• Temperatura ambiente	0 ~ 50°C
• Tensione di esercizio	DC 12V 1A
• Tensione di rete	230V AC / 50/60Hz
• Dimensioni/ NERO	L113 x L73 x A35 (mm)
• Frequenza wireless	2.4GHz, ISM banda, 16 canali
• Classe/tipo di protezione	IP 30
• Test RF	RED 2014/53/EU
• CE	disponibile
• RoHs	disponibile
• Tipo di antenna	Monopoli 2.4GHz

N. art. B-GS-3996

## Caratteristiche

- Per la comunicazione di tutti i termostati unità di controllo ed estensioni Smart-Home di blossom-ic.
- Rilevamento IP automatico quando collegato ad internet.
- Riconoscimento automatico del paese quando collegato ad internet.
- Cavo internet RJ45 tramite connessione LAN.
- Con antenna, cablaggio, ed accessori necessari.
- tecnologia radio blossom-ic , 2.4Ghz, banda ISM, 16 canali.
- Funzionalità di sistema garantita anche senza connessione Internet. Funzionamento manuale disponibile sul termostato.
- Se il gateway è connesso a Internet è possibile effettuare tutte le impostazioni anche tramite l'app.
- L'App blossom-ic è disponibile per tutti gli smartphone e tablet iOS e Android.
- Protezione dati: tutti i dati vengono archiviati esclusivamente nel proprio gateway personale.

## Applicazione

Per il controllo dei prodotti blossom-ic tramite l'App dedicata.

- per prodotti con bilanciamento idraulico ed estensioni Smart Home.  
Con un solo gateway è possibile controllare fino a 20 termostati per sistema.

### Comunicazione ad alta frequenza

- blossom-ic RF: 2.4Ghz, banda ISM , 16 canali.
- Intervallo: fino a 50m negli edifici.



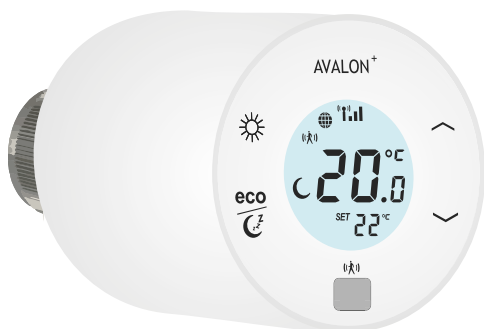

N. art. B-AP-3977

## Dati tecnici

### Avalon+ Termostato radiatore

Intervallo di riferimento	6 ~ 30°C
Temperatura ambiente	0 ~ 50°C
Umidità ambiente	85 % (senza condensa)
Versione	2x Mignon AA 1.5V
Dimensioni	L110 x Ø 58 (mm)
Frequenza wireless	2.4GHz, ISM banda, 16 canali
Classe/tipo di protezione	IP 30
Test RF	RED 2014/53/EU
CE	disponibile
RoHs	disponibile
Connessione	M30 x 1.5 mm
Tipo antenna	Antenna PCB

## Caratteristiche

- Termostato radio per controllare i radiatori.
- Per il collegamento diretto alle valvole del termostato con una connessione filettata M 30 x 1.5 mm.
- La temperatura ambiente appare direttamente sul termostato.
- Il termostato è dotato di sensori di movimento.
- Moderna tecnologia con touchpad.
- Display illuminato.
- Con sistema di rilevamento aperture finestra.
- Versione batteria: Mignon 3V AA 1.5V x 2.
- È possibile controllare fino a 20 termostati tramite un Gateway.
- Insieme con il Gateway GT-100.
- Funzionalità di sistema garantita anche senza connessione Internet. Funzionamento manuale disponibile sul termostato.
- Se il gateway è connesso a Internet è possibile effettuare tutte le impostazioni anche tramite l'app.
- Protezione dati: tutti i dati vengono archiviati esclusivamente nel proprio gateway personale.

## Applicazione

Termostato radio per regolare i radiatori.  
In connessione con il Gateway GT-100.

### Comunicazione ad alta frequenza

- blossom-ic RF: 2.4Ghz, banda ISM , 16 canali.
- Intervallo: fino a 50m negli edifici.

### Attenzione!

- Il sensore non deve essere coperto.  
*Alternativo: Avalon Combo+*

### Bilanciamento idraulico con blossom-ic

Sistema Smart Home blossom-ic con certificazione TÜV  
Processo per il bilanciamento idraulico digitale dinamico  
basato su algoritmi intelligenti.

- › Metodo unico: completamente automatico, indipendente e adattivo
- › Per impianti di riscaldamento a tubazione singola o doppia
- › Nessun bisogno di interventi sulla rete idraulica e delle tubazioni esistenti
- › Tempi di assemblaggio molto ridotti
- › Fino al 30% di risparmio energetico
- › Certificazione TUV





N. art. B-C-3552+

## Dati tecnici

### Avalon Termostato radiatore

Intervallo di riferimento	6 ~ 30°C
Temperatura ambiente	0 ~ 50°C
Umidità ambiente	85 % (senza condensa)
Versione	2x Mignon AA 1.5V
Dimensioni	L100 x L65 x A70 (mm)
Frequenza wireless	2.4GHz, ISM banda, 16 canali
Classe/tipo di protezione	IP 30
Test RF	RED 2014/53/EU
CE	disponibile
RoHs	disponibile
Connessione	M30 x 1.5 mm
Tipo antenna	Antenna PCB

## Caratteristiche

- Termostato radiato radio per controllare i radiatori.
- Per il collegamento diretto alle valvole del termostato con una connessione filettata M 30 x 1.5 mm.
- La temperatura ambiente appare direttamente sul termostato.
- Il termostato è dotato di sensori di movimento.
- Moderna tecnologia con touchpad.
- Display illuminato.
- Con sistema di rilevamento apertura finestra.
- Versione batteria: Mignon 3V AA 1.5V x 2.
- E' possibile controllare fino a 20 termostati tramite un Gateway.
- Insieme con il Gateway GT-100.
- Funzionalità di sistema garantita anche senza connessione Internet. Funzionamento manuale disponibile sul termostato.
- Se il gateway è connesso a Internet è possibile effettuare tutte le impostazioni anche tramite l'app.
- Protezione dati: tutti i dati vengono archiviati esclusivamente nel proprio gateway personale.

## Applicazione

Termostato radio per regolare i radiatori.  
In connessione con il Gateway GT-100.

### Comunicazione ad alta frequenza

- blossom-ic RF: 2.4Ghz, banda ISM , 16 canali.
- Intervallo: fino a 50m negli edifici.

### Attenzione!

- Il sensore non deve essere coperto.  
*Alternativo: Avalon Combo+*

### Bilanciamento idraulico con blossom-ic

Sistema Smart Home blossom-ic con certificazione TÜV  
Processo per il bilanciamento idraulico digitale dinamico  
basato su algoritmi intelligenti.

- › Metodo unico: completamente automatico, indipendente e adattivo
- › Per impianti di riscaldamento a tubazione singola o doppia
- › Nessun bisogno di interventi sulla rete idraulica e delle tubazioni esistenti
- › Tempi di assemblaggio molto ridotti
- › Fino al 30% di risparmio energetico
- › Certificazione TUV





## Dati tecnici

Avalon Combo+ Termostato	
Intervallo di riferimento	6 ~ 30°C
Temperatura ambiente	0 ~ 50°C
Umidità ambiente	90% (senza condensa)
Versione	4x Mignon AAA 1.5V
Dimensioni	L86 x L86 x A42 (mm)
Frequenza wireless	2.4GHz, ISM banda, 16 canali
Classe/tipo di protezione	IP 30
Test RF	RED 2014/53/EU
CE	disponibile
RoHs	disponibile
Tipo antenna	Antenna PCB

N. art. B-ACPT-3982

## Caratteristiche

- Termostato ambiente radio per regolare i radiatori e i ventil convettori schermati da tende o copritermo.
- Da utilizzare in combinazione con l'attuatore Avalon Combo+.
- E' possibile controllare simultaneamente fino a 10 attuatori con un termostato ambiente radio.
- La temperatura ambiente appare direttamente sul termostato.
- Il termostato è dotato di sensori di movimento.
- Moderna tecnologia con touchpad.
- Display illuminato.
- Con sistema di rilevamento aperture finestra.
- Versione batteria: Mignon AAA 1.5V x 4.
- E' possibile controllare fino a 20 termostati tramite un Gateway.
- Insieme con il Gateway GT-100.
- Funzionalità di sistema garantita anche senza connessione Internet. Funzionamento manuale disponibile sul termostato.
- Se il gateway è connesso a Internet è possibile effettuare tutte le impostazioni anche tramite l'app.
- Protezione dati: tutti i dati vengono archiviati esclusivamente nel proprio Gateway personale.

## Applicazione

Per controllare i radiatori schermati in combinazione con l'attuatore Avalon Combo+. In connessione con il Gateway GT-100.

### Comunicazione ad alta frequenza

- blossom-ic RF: 2.4Ghz, banda ISM, 16 canali.
- Intervallo: fino a 50m negli edifici.

### Bilanciamento idraulico con blossom-ic

Sistema Smart Home blossom-ic con certificazione TÜV  
Processo per il bilanciamento idraulico digitale dinamico  
basato su algoritmi intelligenti.

- Metodo unico: completamente automatico, indipendente e adattivo
- Per impianti di riscaldamento a tubazione singola o doppia
- Nessun bisogno di interventi sulla rete idraulica e delle tubazioni esistenti
- Tempi di assemblaggio molto ridotti
- Fino al 30% di risparmio energetico
- Certificazione TÜV



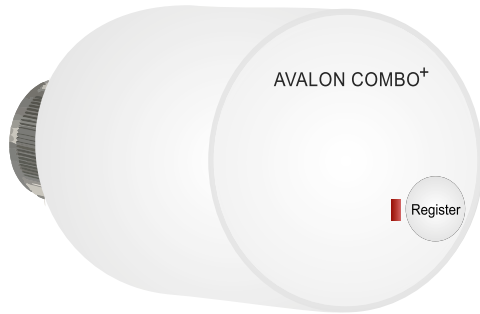

N. art. B-ACST-3978

## Dati tecnici

### Avalon Combo<sup>+</sup> Attuatore

Intervallo di riferimento	6 ~ 30°C
Temperatura ambiente	0 ~ 50°C
Umidità ambiente	90 % (senza condensa)
Versione	2x Mignon AA 1.5V
Dimensioni	L110 x Ø 58 (mm)
Frequenza wireless	2.4GHz, ISM banda, 16 canali
Classe/tipo di protezione	IP 30
Test RF	RED 2014/53/EU
CE	disponibile
RoHs	disponibile
Connessione	M30 x 1.5 mm
Tipo antenna	Antenna PCB

## Caratteristiche

- Per controllare i radiatori e i ventili convettori schermati da tende o copritermo in combinazione con il termostato Avalon Combo<sup>+</sup>.
- E' possibile controllare simultaneamente fino a 10 attuatori con un termostato ambiente radio.
- Per il collegamento diretto alle valvole del radiatore con una connessione filettata M 30 x 1.5 mm.
- Versione batteria: Mignon AA 1.5V x 2.
- Insieme con il Gateway GT-100.
- Funzionalità di sistema garantita anche senza connessione Internet. Funzionamento manuale disponibile sul termostato.
- Se il gateway è connesso a Internet è possibile effettuare tutte le impostazioni anche tramite l'app.
- Protezione dati: tutti i dati vengono archiviati esclusivamente nel proprio Gateway personale.

## Applicazione

Per controllare i radiatori se il sensore è coperto in combinazione con il termostato Avalon Combo<sup>+</sup>. In connessione con il Gateway GT-100.

### Comunicazione ad alta frequenza

- blossom-ic RF: 2.4Ghz, banda ISM , 16 canali.
- Intervallo: fino a 50m negli edifici.

### Bilanciamento idraulico con blossom-ic

Sistema Smart Home blossom-ic con certificazione TÜV  
Processo per il bilanciamento idraulico digitale dinamico basato su algoritmi intelligenti.

- Metodo unico: completamente automatico, indipendente e adattivo
- Per impianti di riscaldamento a tubazione singola o doppia
- Nessun bisogno di interventi sulla rete idraulica e delle tubazioni esistenti
- Tempi di assemblaggio molto ridotti
- Fino al 30% di risparmio energetico
- Certificazione TUV







## Dati tecnici

### Tarus String Unità di controllo

Intervallo di riferimento	6 ~ 30°C
Temperatura ambiente	0 ~ 50°C
Umidità ambiente	90% (senza condensa)
Tensione di rete	230V AC / 50/60Hz
Dimensioni	L96 x L53 x A70 (mm)
Frequenza wireless	2.4GHz, banda ISM, 16 canali
Classe/tipo di protezione	IP 30
Test RF	RED 2014/53/EU
CE	disponibile
RoHs	disponibile
Tipo antenna	Antenna PCB

N. art. B-TST-3748

## Caratteristiche

- Per controllare e regolare la singola tubazione.
- Adatto per tutti i tubi separati, di mandata idraulica e di ritorno.
- È possibile controllare fino a 20 Avalon e/o Avalon Combo con un Tarus String.
- Ad un unico gateway possono essere collegate fino a 20 Tarus String.
- Ripetitore per il sistema blossom-ic.
- Insieme con il Gateway GT-100.
- Funzionalità di sistema garantita anche senza connessione Internet. Funzionamento manuale disponibile sul termostato.
- Se il gateway è connesso a Internet è possibile effettuare tutte le impostazioni anche tramite l'app.
- Protezione dati: tutti i dati vengono archiviati esclusivamente nel proprio Gateway personale.

## Applicazione

Per controllare e regolare gli impianti di riscaldamento monotubo. Insieme con i termostati per radiatore Avalon e Avalon. Insieme con il Gateway GT-100. Combo Può essere utilizzato anche con i prodotti plus.

### Comunicazione ad alta frequenza

- blossom-ic RF: 2.4Ghz, banda ISM , 16 canali.
- Intervallo: fino a 50m negli edifici.

### Attenzione!

- Appena tutti i termostati radiatore hanno raggiunto la temperatura desiderata, la Taurus String chiude il tubo di mandata.

### Dati tecnici valvola:

1 "connessione con filettatura esterna  
Versione M30 x 1.5 mm



## Collettore Premontato

- idoneo per il controllo del sistema radiante a pavimento a bassa temperatura
- idoneo per il controllo del sistema tradizionale a radiatori ad alta temperatura

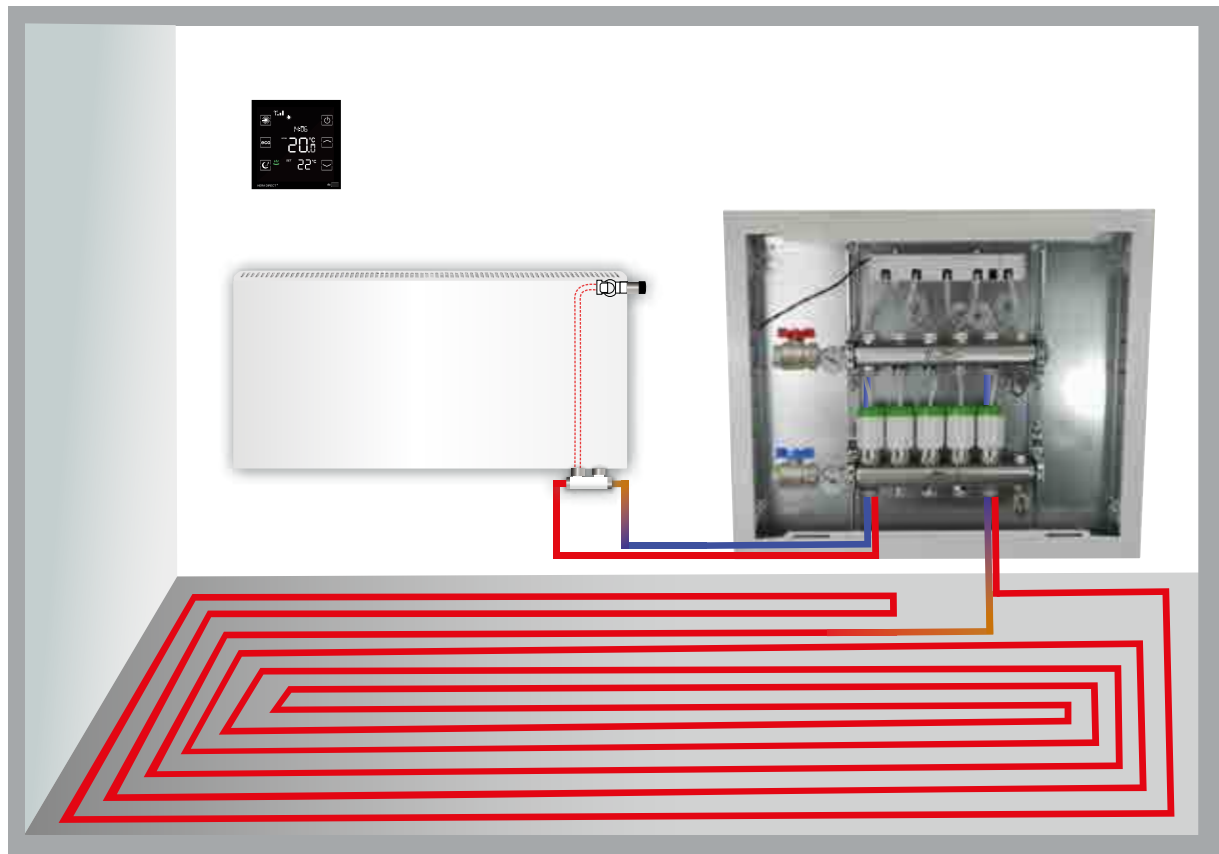

## IVR 803 KIT S disponibile da 2 a 12 attacchi Caratteristiche:

Collettore premontato in acciaio AISI 304 diametro 1" con uscite 3/4 EK ad interasse 50 mm composto da:

- collettore di mandata con detentore micrometrico di intercettazione per ogni singolo circuito, valvola di sfiato aria manuale e valvola di carico/scarico acqua
- collettore di ritorno con attuatore radio per ogni singola circuito, valvola di sfiato aria e valvola di carico/scarico acqua
- coppia di valvole a sfera a bocchettone con termometro 0-80°C e tappi diametro 1"
- coppia di zanche di fissaggio antivibranti
- barra radio per collegamento attuatori
- Sensori di temperatura

\*Cassetta esclusa

## Dati tecnici

### Hera<sup>+</sup> Primus Barra radio per sistema a collettore (base)

Consumo energetico	max. 12 W (per 30 attuatori)
Dimensioni	L262 x L46 x A28 (mm)
Tensione di esercizio	DC 12 ~ 24V 1A
Tensione di rete	230V AC / 50/60Hz
Porta di collegamento	Cavo patch RJ11
Luce LED	Connessione internet e radio
Classe/tipo di protezione	IP 30
Espandibile con	fino a 4 barre per riscaldamento a pavimento radio Hera <sup>+</sup>
Test RF	RED 2014/53/EU
CE	disponibile
RoHs	disponibile
Tipo antenna	Antenna PCB

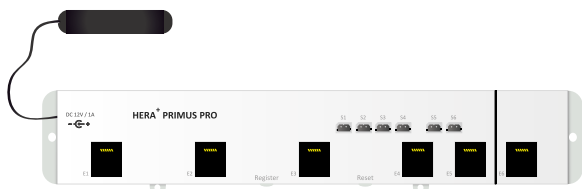

N. art. B-HPPR-4020



N. art. B-HRTF-4040

## Caratteristiche

- Barra radio, per controllare i singoli ambienti tramite termostato ambiente Hera<sup>+</sup> o termostato ambiente radio Hera Direct<sup>+</sup> e Hera<sup>+</sup> attuatore.
- Espandibile con barra radio Hera<sup>+</sup> Extensia PRO.
- Collegamento agli attuatori tramite cavo patch Rj11.
- Controllo a 6 zone con un attuatore per porta.
- È possibile controllare simultaneamente fino a 150 attuatori con un termostato.
- Antenna esterna ultra-piatta.
- Nessun intervento elettrico necessario – sistema di collegamento finito con jack RJ 11 (plug, patch, play).
- Incluso cavo di alimentazione da 1.5 metri.
- Con un unico Gateway è possibile controllare fino a 5 Hera<sup>+</sup> Primus.
- Ripetitore per il sistema blossom-ic.
- Insieme con il Gateway GT-100.
- Protezione dati: tutti i dati vengono archiviati esclusivamente nel proprio Gateway personale.
- Sensore temperatura per rilevazione della temperatura sul singolo circuito, da posizionare a contatto con la tubazione

## Applicazione

Barra radio per collettore (modulo a 6 zone) in combinazione con i termostati ambiente wireless Hera<sup>+</sup>/ Direct<sup>+</sup> ed Hera<sup>+</sup> attuatori, per la regolazione del singolo ambiente. In connessione con il Gateway GT-100

consente un controllo preciso del riscaldamento a collettore attraverso motori passo-passo. La tecnologia blossom-ic stabilisce e regola l'energia necessaria per una temperatura ambiente ottimale.

### Comunicazione ad alta frequenza

- blossom-ic RF: 2.4Ghz, banda ISM, 16 canali.
- Intervallo: fino a 50m negli edifici.



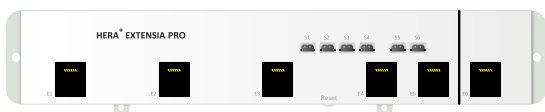

## Dati tecnici

### Hera<sup>+</sup> Extensia Barra radio per sistema a collettore (estensione)

Consumo energetico	max. 12 W (per 30 attuatori)
Dimensioni	L230 x L46 x A28 (mm)
Tensione di esercizio	DC 12 ~ 24V 1A
Alimentazione	Connettore BUS estensione
Porta di collegamento	Cavo patch RJ11
Luce LED	Connessione internet e radio
Classe/tipo di protezione	IP 30
Espandibile con	fino a 4 Hera <sup>+</sup> Extensia con un Hera <sup>+</sup> Primus PRO
CE	disponibile
RoHs	disponibile

N. art. B-HEPR-4060

## Caratteristiche

- Barra radio, per controllare i singoli ambienti tramite termostato ambiente Hera<sup>+</sup> o termostato ambiente radio Hera Direct<sup>+</sup> e Hera<sup>+</sup> attuatore.
- Ampliamento della barra radio Hera<sup>+</sup> Primus PRO.
- controllo a 6 zone con un attuatore per porta.
- Inclusa prolunga per collegamento a Hera<sup>+</sup> Primus PRO- non è necessario un nuovo collegamento all'alimentatore. La barra di espansione riceve l'alimentazione dalla barra Hera<sup>+</sup> Primus PRO.
- Fino a 4 barre per il riscaldamento a pavimento radio Hera<sup>+</sup> Extensia PRO può essere collegata ad un Hera<sup>+</sup> Primus PRO.
- È possibile controllare simultaneamente fino a 150 attuatori con un termostato.
- Nessun intervento elettrico necessario –sistema di collegamento finito con jack RJ 11 (plug, patch, play).
- Ripetitore per il sistema blossom-ic.
- Insieme con il Gateway GT-100.
- Protezione dati: tutti i dati vengono archiviati esclusivamente nel proprio Gateway personale.
- Abbinabile al sensore di temperatura articolo B-HRTF-4040

## Applicazione

Barra radio (modulo di espansione a 6 zone) in combinazione con i termostati ambiente wireless Hera<sup>+</sup> / Direct<sup>+</sup> ed Hera<sup>+</sup> attuatori, per la regolazione del singolo ambiente.  
Quando connesso con il Gateway GT-100.

consente un controllo preciso del riscaldamento a collettore attraverso motori passo-passo. La tecnologia blossom-ic determina e regola l'energia necessaria per una temperatura ambiente ottimale.

### Comunicazione ad alta frequenza

- blossom-ic RF: 2.4Ghz, banda ISM , 16 canali.
- Intervallo: fino a 50m negli edifici.





## Dati tecnici

### Hera+ Actor Attuatore

• Temperatura ambiente	0 ~ 50°C
• Tensione	6 V
• Forza di chiusura	< 100 N
• Porta di collegamento	Cavo patch RJ11
• Connessione	M30 x 1.5 mm
• Dimensioni	L90 x Ø 46 (mm)
• Classe/tipo di protezione	IP 30
• Test RF	RED 2014/53/EU
• CE	disponibile
• RoHs	disponibile

N. art. B-HAC-3974

## Caratteristiche

- In uso con la barra radio Hera+ Primus PRO e Hera+ Extensia PRO per un controllo preciso del riscaldamento a collettore.
- Controlla la temperatura ambiente esatta tramite il termostato ambiente radio Hera+ o il termostato ambiente Hera Direct+.
- È possibile controllare simultaneamente fino a 150 attuatori con un termostato.
- Attuatore M30 x 1.5 mm.
- Incluso il cavo jack lungo 85 cm RJ 11.
- Alimentazione tramite cavo jack RJ 11.
- Nessun intervento elettrico necessario – sistema di collegamento finito con jack RJ 11 (plug, patch, play).
- Insieme con il Gateway GT-100.
- Protezione dati: tutti i dati vengono archiviati esclusivamente nel proprio Gateway personale.

## Applicazione

Attuatore blossom-ic per il controllo del riscaldamento a collettore. Installazione in tutti i distributori standard Supporto valvola M30 x 1,5 mm.

In combinazione con Hera+ Primus / Hera+ Extensia Barre di riscaldamento a collettore radio e termostati ambiente radio Hera+ / Hera Direct+.  
Collegabile con il Gateway GT-100.

La tecnologia blossom-ic stabilisce e regola il flusso energetico, necessario per il raggiungimento di una temperatura ambiente ottimale.

### Comunicazione ad alta frequenza

- blossom-ic RF: 2.4Ghz, banda ISM, 16 canali.
- Intervallo: fino a 50m negli edifici.





N. art. B-HPT-3975

## Dati tecnici

### Hera<sup>+</sup> Termostato

Intervallo di riferimento	6 ~ 30°C
Temperatura ambiente	0 ~ 50°C
Umidità ambiente	90 % (senza condensa)
Versione	4x Mignon AAA 1.5V
Dimensioni	L86 x L86 x A42 (mm)
Frequenza wireless	2.4GHz, banda ISM, 16 canali
Classe/tipo di protezione	IP 30
Test RF	RED 2014/53/EU
CE	disponibile
RoHs	disponibile
Tipo antenna	Antenna PCB

## Caratteristiche

- Termostato ambiente radio da usare in combinazione con la barra radio Hera<sup>+</sup> Primus/ Extensia PRO e Hera<sup>+</sup> Actors.
- È possibile controllare simultaneamente fino a 150 attuatori con un termostato ambiente.
- La temperatura ambiente appare direttamente sul termostato.
- Il termostato è dotato di sensori di movimento.
- Moderna tecnologia con touchpad.
- Display illuminato.
- Versione batteria: Mignon AAA 1.5V x 4.
- Insieme con il Gateway GT-100.
- Funzionalità di sistema garantita anche senza connessione Internet. Funzionamento manuale disponibile sul termostato.
- Se il gateway è connesso a Internet è possibile effettuare tutte le impostazioni anche tramite l'app.
- Protezione dati: tutti i dati vengono archiviati esclusivamente nel proprio Gateway personale.

## Applicazione

Termostato ambiente radio con combinazione con le barre Hera<sup>+</sup> e Hera<sup>+</sup> Actors, per il controllo di singoli ambienti. Insieme con il gateway GT-100.

Consente un controllo preciso del riscaldamento a collettori tramite motori passo a passo. La tecnologia blossom-ic determina e regola l'energia necessaria per una temperatura ambiente.

### Comunicazione ad alta frequenza

- blossom-ic RF: 2.4Ghz, banda ISM, 16 canali.
- Intervallo: fino a 50m negli edifici.







## Dati tecnici

### Hera Direct+ Termostato

Intervallo di riferimento	6 ~ 30°C
Temperatura ambiente	0 ~ 50°C
Umidità ambiente	90 % (senza condensa)
Tensione di rete	230V AC / 50/60Hz
Dimensioni	L86 x L86 x A44 (mm)
Frequenza wireless	2.4GHz, banda ISM, 16 canali
Classe/tipo di protezione	IP 30
Test RF	RED 2014/53/EU
CE	disponibile
RoHs	disponibile
Tipo antenna	Antenna PCB

N. art. B-HDP-3976

## Caratteristiche

- Il termostato può essere utilizzato in due modi. Per controllare gli attuatori tradizionali (cablati direttamente) o in combinazione con le barre radio Hera+ Primus/Extensia PRO e Hera+Actors.
- Termostato (corpo), adatto per tutte le prese standard a incasso con diam. 60 mm.
- È possibile controllare simultaneamente fino a 150 attuatori con un termostato ambiente.
- Adatto anche per controllare i tradizionali attuatori (NC o NO) 230V (cablati direttamente).
- La temperatura ambiente appare direttamente sul termostato.
- Il termostato è dotato di sensori di movimento.
- Moderna tecnologia con touchpad.
- Display illuminato con oscuramento notturno automatico al buio.
- Ripetitore per il sistema blossom-ic.
- Insieme con il Gateway GT-100.
- Funzionalità di sistema garantita anche senza connessione Internet. Funzionamento manuale disponibile sul termostato.
- Se il gateway è connesso a Internet è possibile effettuare tutte le impostazioni anche tramite l'app.
- Protezione dati: tutti i dati vengono archiviati esclusivamente nel proprio Gateway personale.

## Applicazione

Termostato ambiente UP in combinazione con barre per il riscaldamento a pavimento Hera+e Hera+ Actors, per il controllo di singoli ambienti. Insieme con il gateway GT-100.

Consente un controllo preciso tramite motori passo a passo. La tecnologia blossom-ic determina e regola l'energia necessaria per una temperatura ambiente.

### Comunicazione ad alta frequenza

- blossom-ic RF: 2.4Ghz, banda ISM , 16 canali.
- Intervallo: fino a 50m negli edifici.





N. art. B-N-3549

## Dati tecnici

### Hera Direct Termostato

Intervallo di riferimento	6 ~ 30°C
Temperatura ambiente	0 ~ 50°C
Umidità ambiente	90 % (senza condensa)
Tensione di rete	230V AC / 50/60Hz
Dimensioni	L86 x L86 x A44 (mm)
Frequenza wireless	2.4GHz, banda ISM, 16 canali
Classe/tipo di protezione	IP 30
Test RF	RED 2014/53/EU
CE	disponibile
RoHS	disponibile
Attuatori	versione (NC) o (NO)
Tipo antenna	Antenna PCB

## Caratteristiche

- Termostato, per controllare gli attuatori cablati direttamente (230V).
- Termostato (corpo), adatto per tutte le prese a incasso con diam. 60 mm.
- La temperatura ambiente appare direttamente sul termostato.
- Il termostato è dotato di sensori di movimento.
- Moderna tecnologia con touchpad.
- Display illuminato con oscuramento notturno automatico al buio.
- Ripetitore per il sistema blossom-ic.
- Insieme con il Gateway GT-100.
- Funzionalità di sistema garantita anche senza connessione Internet. Funzionamento manuale disponibile sul termostato.
- Se il gateway è connesso a Internet è possibile effettuare tutte le impostazioni anche tramite l'app.
- Protezione dati: tutti i dati vengono archiviati esclusivamente nel proprio Gateway personale.

## Applicazione

Per controllare il riscaldamento a collettori tramite gli attuatori (NC) o (NO) sul distributore, direttamente cablati. Insieme con il Gateway GT-100.

### Comunicazione ad alta frequenza

- blossom-ic RF: 2.4Ghz, banda ISM , 16 canali.
- Intervallo: fino a 50m negli edifici.





N. art. B-A-3544

## Dati tecnici

### Magelan Sistema di controllo caldaia

Intervallo di riferimento	6 ~ 30°C
Temperatura ambiente	0 ~ 50°C
Umidità ambiente	90 % (senza condensa)
Tensione di rete	230V AC / 50/60Hz
Dimensioni	L86 x L86 x A44 (mm)
Frequenza wireless	2.4GHz, banda ISM, 16 canali
Classe/tipo di protezione	IP 30
Test RF	RED 2014/53/EU
CE	disponibile
RoHs	disponibile
Tipo antenna	Antenna PCB

## Caratteristiche

- Da verificare preventivamente l'abbinamento al modello della caldaia esistente.
- Per il cablaggio sull'uscita priva di potenziale della caldaia.
- Per tutte le caldaie correnti
- Per l'uso insieme con il termostato ambiente radio Magelan.
- Ripetitore per il sistema blossom-ic.
- Insieme con il Gateway GT-100.
- Funzionalità di sistema garantita anche senza connessione Internet. Funzionamento manuale disponibile sul termostato.
- Se il gateway è connesso a Internet è possibile effettuare tutte le impostazioni anche tramite l'app.
- Protezione dati: tutti i dati vengono archiviati esclusivamente nel proprio Gateway personale.

## Applicazione

Per il controllo delle caldaie a compensazione climatica o semplificate. In combinazione con il termostato radio Magelan. In connessione con Gateway GT-100.

caldaie con sistema bus, utilizzabile soltanto con un componente aggiuntivo del relativo produttore della caldaia.

### Comunicazione ad alta frequenza

- blossom-ic RF: 2.4Ghz, banda ISM , 16 canali.
- Intervallo: fino a 50m negli edifici.



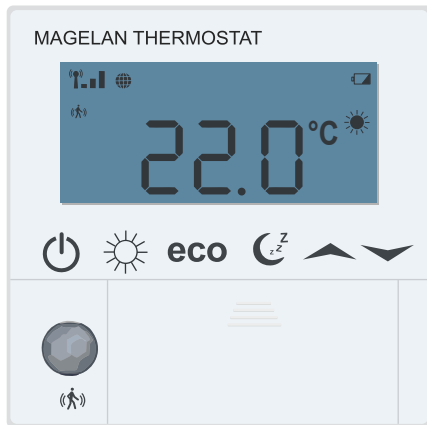

N. art. B-AT-3545

## Dati tecnici

### Magelan Termostato

Intervallo di riferimento	6 ~ 30°C
Temperatura ambiente	0 ~ 50°C
Umidità ambiente	90 % (senza condensa)
Versione	2x Mignon AA 1.5V
Dimensioni	L86 x L86 x A20 (mm)
Frequenza wireless	2.4GHz, banda ISM, 16 canali
Classe/tipo di protezione	IP 30
Test RF	RED 2014/53/EU
CE	disponibile
RoHs	disponibile
Tipo antenna	Antenna PCB

## Caratteristiche

- Termostato ambiente radio, per controllare sistemi di caldaia con termoregolazione.
- Da utilizzare insieme con il sistema di controllo caldaia Magelan.
- La temperatura ambiente appare direttamente sul termostato.
- Il termostato è dotato di sensori di movimento.
- Moderna tecnologia con touchpad
- Display illuminato.
- Versione batteria: Mignon AA 1.5V x 2.
- Insieme con il Gateway GT-100.
- Funzionalità di sistema garantita anche senza connessione Internet. Funzionamento manuale disponibile sul termostato.
- Se il gateway è connesso a Internet è possibile effettuare tutte le impostazioni anche tramite l'app.
- Protezione dati: tutti i dati vengono archiviati esclusivamente nel proprio Gateway personale.

## Applicazione

Per il controllo delle caldaie a compensazione climatica o semplici. In combinazione con il regolatore Magelan. Collegabile con il Gateway GT-100.

caldaie con sistema bus, utilizzabile soltanto con un componente aggiuntivo del relativo produttore della caldaia.

### Comunicazione ad alta frequenza

- blossom-ic RF: 2.4Ghz, banda ISM , 16 canali.
- Intervallo: fino a 50m negli edifici.





## Dati tecnici

### Magelan Combo Termostato

Intervallo di riferimento	6 ~ 30°C
Temperatura ambiente	0 ~ 50°C
Umidità ambiente	90 % (senza condensa)
Tensione di rete	230V AC / 50/60Hz
Dimensioni	L86 x L86 x A44 (mm)
Frequenza wireless	2.4GHz, banda ISM, 16 canali
Classe/tipo di protezione	IP 30
Test RF	RED 2014/53/EU
CE	disponibile
RoHs	disponibile
Tipo antenna	Antenna PCB

N. art. B-AC-3546

## Caratteristiche

- Termostato ambiente per controllare sistemi di caldaie regolati dall'ambiente.
- Il termostato ambiente è cablato direttamente sulla caldaia.
- Termostato (corpo), adatto per tutte le prese a incasso con diam. 60 mm.
- La temperatura ambiente appare direttamente sul termostato.
- Il termostato è dotato di sensori di movimento.
- Moderna tecnologia con touchpad.
- Display illuminato con oscuramento notturno automatico al buio.
- Ripetitore per il sistema blossom-ic.
- Insieme con il Gateway GT-100.
- Funzionalità di sistema garantita anche senza connessione Internet. Funzionamento manuale disponibile sul termostato.
- Se il gateway è connesso a Internet è possibile effettuare tutte le impostazioni anche tramite l'app.
- Protezione dati: tutti i dati vengono archiviati esclusivamente nel proprio Gateway personale.

## Applicazione

Per controllare sistemi di caldaie regolati dall'ambiente. Il termostato è cablato direttamente sulla caldaia. Insieme con il Gateway GT-100.

caldaie con sistema bus, utilizzabile soltanto con un componente aggiuntivo del relativo produttore della caldaia.

### Comunicazione ad alta frequenza

- blossom-ic RF: 2.4Ghz, banda ISM , 16 canali.
- Intervallo: fino a 50m negli edifici.





N. art. B-T-3587

## Dati tecnici

### Tarus Unità di controllo

Intervallo di riferimento	6 ~ 30°C
Temperatura ambiente	0 ~ 50°C
Umidità ambiente	90 % (senza condensa)
Tensione di rete	230V AC / 50/60Hz
Dimensioni	L96 x L53 x A70 (mm)
Frequenza wireless	2.4GHz, banda ISM, 16 canali
Classe/tipo di protezione	IP 30
Test RF	RED 2014/53/EU
CE	disponibile
RoHs	disponibile
Tipo antenna	Antenna PCB

## Caratteristiche

- Per controllare appartamenti singoli in case multifamiliari con tubazioni separate di mandata e ritorno
- In combinazione con il termostato ambiente radio Tarus.
- Adatto anche per sistemi di riscaldamento a tubazione singola per la regolazione del circuito.
- Ripetitore per il sistema blossom-ic.
- Insieme con il Gateway GT-100.
- Funzionalità di sistema garantita anche senza connessione Internet. Funzionamento manuale disponibile sul termostato.
- Se il gateway è connesso a Internet è possibile effettuare tutte le impostazioni anche tramite l'app.
- Protezione dati: tutti i dati vengono archiviati esclusivamente nel proprio Gateway personale.

## Applicazione

Per controllare i piani, in combinazione con il termostato ambiente radio Tarus. Insieme con il Gateway GT-100.

### Comunicazione ad alta frequenza

- blossom-ic RF: 2.4Ghz, banda ISM , 16 canali.
- Intervallo: fino a 50m negli edifici.

### Dati tecnici valvola:

1 "connessione con 2 filettature esterne





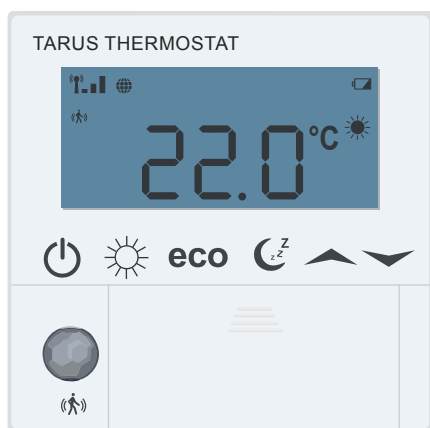

N. art. B-TT-3588

## Dati tecnici

### Tarus Termostato

Intervallo di riferimento	6 ~ 30°C
Temperatura ambiente	0 ~ 50°C
Umidità ambiente	90 % (senza condensa)
Versione	2x Mignon AA 1.5V
Dimensioni	L86 x L86 x A20 (mm)
Frequenza wireless	2.4GHz, banda ISM, 16 canali
Classe/tipo di protezione	IP 30
Test RF	RED 2014/53/EU
CE	disponibile
RoHs	disponibile
Tipo antenna	Antenna PCB

## Caratteristiche

- Termostato ambiente radio per controllare singoli appartamenti in case multifamiliari con tubazioni separate, di mandata e di ritorno.
- Da utilizzare insieme con il sistema di controllo Tarus e apposita valvola tarus, avente filettatura esterna da 1".
- La temperatura ambiente appare direttamente sul termostato.
- Il termostato è dotato di sensori di movimento.
- Moderna tecnologia con touchpad
- Display illuminato.
- Versione batteria: Mignon AA 1.5V x 2.
- Insieme con il Gateway GT-100.
- Funzionalità di sistema garantita anche senza connessione Internet. Funzionamento manuale disponibile sul termostato.
- Se il gateway è connesso a Internet è possibile effettuare tutte le impostazioni anche tramite l'app.
- Protezione dati: tutti i dati vengono archiviati esclusivamente nel proprio Gateway personale.

## Applicazione

Per controllare i piani, in combinazione l'unità di controllo Tarus e la sezione inferiore della valvola Tarus 1" filettatura esterna. Insieme con il Gateway GT-100.

### Comunicazione ad alta frequenza

- blossom-ic RF: 2.4Ghz, banda ISM , 16 canali.
- Intervallo: fino a 50m negli edifici.



# ESTENSIONI SMART-HOME



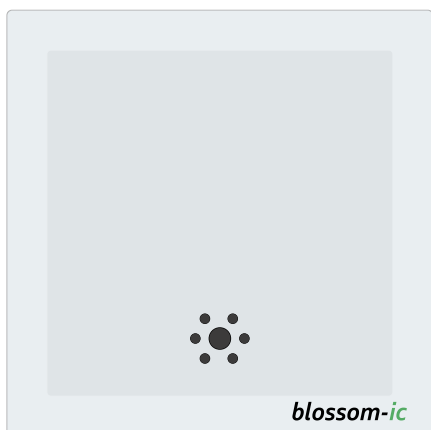

## Dati tecnici

### Magelan Sirena

• Temperatura ambiente	0 ~ 50°C
• Tensione di rete	230V AC / 50/60Hz
• Dimensioni	L86 x L86 x A59,5 (mm)
• Frequenza wireless	2.4GHz, banda ISM, 16 canali
• Classe/tipo di protezione	IP 30
• Test RF	RED 2014/53/EU
• CE	disponibile
• RoHs	disponibile
• Tipo antenna	Antenna PCB
• Volume	80 dB

N. art. B-MSI-3968

## Caratteristiche

- Da utilizzare insieme con i termostati blossom-ic e/o il sensore aggiuntivo Magelan.
- Utilizzabile anche come sirena d'allarme in caso di danni idrici.
- Appena la sirena d'allarme Magelan viene attivata, ogni Smartphone registrato riceve una notifica push Insieme immediatamente.
- La sirena è installata in modo permanente a 230V.
- Ripetitore per il sistema blossom-ic.
- Insieme con il Gateway GT-100.
- Protezione dati: tutti i dati vengono archiviati esclusivamente nel proprio Gateway personale.

## Applicazione

La sirena Magelan può essere utilizzata in combinazione con il sistema di rilevamento perdite e/o i sensori sui termostati come sistema di allarme interno. Collegabile con il Gateway GT-100.

### Comunicazione ad alta frequenza

- blossom-ic RF: 2.4Ghz, banda ISM , 16 canali.
- Intervallo: fino a 50m negli edifici.



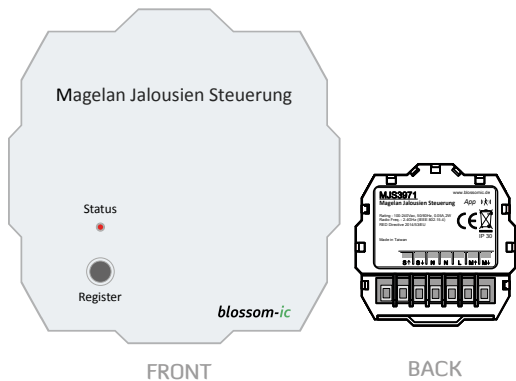

## Dati tecnici

### Magelan Controllo delle veneziane

• Temperatura ambiente	0 ~ 50°C
• Tensione di rete	230V AC / 50/60Hz
• Dimensioni	L54 x L54 x B32 (mm)
• Frequenza wireless	2.4GHz, banda ISM, 16 canali
• Classe/tipo di protezione	IP 30
• Test RF	RED 2014/53/EU
• CE	disponibile
• RoHs	disponibile
• Tipo antenna	Antenna PCB

N. art. B-MJS-3971

## Caratteristiche

- Per controllare le veneziane tramite app (possibile anche da remoto).
- Possibilità di collegamento di diversi tipi di motore.
- Programmi personalizzati per il controllo delle veneziane.
- Ripetitore per il sistema blossom-ic.
- Insieme con il Gateway GT-100.
- Protezione dati: tutti i dati vengono archiviati esclusivamente nel proprio Gateway personale.

## Applicazione

Il modulo veneziana può essere installato nelle prese incassate o nella scatola di movimentazione. Consente un controllo individuale delle veneziane. In connessione con il Gateway GT-100.

### Comunicazione ad alta frequenza

- blossom-ic RF: 2.4Ghz, banda ISM , 16 canali.
- Intervallo: fino a 50m negli edifici.





## Dati tecnici

### Magelan Sensore

• Temperatura ambiente	0 ~ 50°C
• Umidità ambiente	90 % (senza condensa)
• Versione	batteria al litio della durata di 10 anni 3.6V
• Dimensioni	Ø 75 mm x D37 (mm)
• Frequenza wireless	2.4GHz, banda ISM, 16 canali
• Classe/tipo di protezione	IP 30
• Test RF	RED 2014/53/EU
• CE	disponibile
• RoHs	disponibile
• Tipo antenna	Antenna PCB

N. art. B-MSE-3967

## Caratteristiche

- Rilevatore di presenza controllato tramite radio e app, per un monitoraggio aggiuntivo delle singole stanze nel caso in cui non siano installati i termostati blossom-ic.
- Con batteria della durata di 10 anni.
- Insieme con il Gateway GT-100.
- Protezione dati: tutti i dati vengono archiviati esclusivamente nel proprio Gateway personale.

## Applicazione

Per monitorare le singole stanze con funzione antifurto. Per una copertura aggiuntiva delle singole stanze se non è montato alcun termostato blossom-ic. Utilizzabile in combinazione con la sirena Magelan come sistema di allarme interno. In connessione con il Gateway GT-100.

### Comunicazione ad alta frequenza

- blossom-ic RF: 2.4Ghz, banda ISM, 16 canali.
- Intervallo: fino a 50m negli edifici.





N. art. B-ZR-3997

## Dati tecnici

### Magelan sistema di controllo pompa di circolazione

• Temperatura ambiente	0 ~ 50°C
• Tensione di rete	230V AC / 50/60Hz
• Dimensioni	L86 x L86 x A44 (mm)
• Frequenza wireless	2.4GHz, banda ISM, 16 canali
• Classe/tipo di protezione	IP 30
• Test RF	RED 2014/53/EU
• CE	disponibile
• RoHs	disponibile
• Tipo antenna	Antenna PCB
• Lunghezza della sonda	2 metri

## Caratteristiche

- Per controllare la pompa di circolazione.
- Può essere utilizzato in tutte le stanze con rubinetti dell'acqua calda (ad es. in cucina o in bagno).
- Ogni pompa di circolazione tradizionale può essere collegata al sistema di controllo della pompa di circolazione Magelan.
- In combinazione con i sensori di movimento sui termostati e/o sul sensore Magelan..
- Ripetitore per il sistema blossom-ic.
- Insieme con il Gateway GT-100.
- Protezione dati: tutti i dati vengono archiviati esclusivamente nel proprio Gateway personale.

## Applicazione

Per il controllo della pompa di circolazione.  
In connessione con Gateway GT-100.

Una volta selezionato il sensore di rilevamento di movimento il regolatore attiva la pompa di circolazione secondo l'intervallo di tempo impostato. Questo assicura che l'acqua calda sia subito disponibile. In alternativa, è possibile impostare manualmente l'intervallo e la durata tramite l'App.

Una volta collegato il sensore del tubo, è possibile assegnare la temperatura di accensione e spegnimento.  
*Esempio: Quando la temperatura di raffreddamento del condotto di circolazione scende al di sotto di 56°C la pompa si accende automaticamente assicurando la circolazione del tubo dell'acqua calda (Protezione antilegionella).*

### Comunicazione ad alta frequenza

- blossom-ic RF: 2.4Ghz, banda ISM , 16 canali.
- Intervallo: fino a 50m negli edifici.







## Dati tecnici

### Magelan Sensore rilevatore di perdite

• Temperatura ambiente	0 ~ 50°C
• Umidità ambiente	90 % (senza condensa)
• Versione	batteria al litio della durata di 10 anni 3.6V
• Dimensioni elemento di controllo Dimensioni sensore di terra	Ø 75 mm x D31 (mm) L38 x L58 x A38 (mm)
• Frequenza wireless	2.4GHz, banda ISM, 16 canali
• Test RF	RED 2014/53/EU
• CE	disponibile
• RoHs	disponibile
• Tipo antenna	Antenna PCB
• Cavo lunghezza	2 metri

N. art. B-MLS-3969

## Caratteristiche

- Monitoraggio permanente di singole aree o in cantine.
- Segnala fuoriuscite e perdite di acqua.
- Non appena il sensore delle perdite rileva una fuoriuscita di acqua (da un livello dell'acqua di 3 mm), la linea principale dell'acqua viene chiusa immediatamente tramite il sistema di protezione principale dall'acqua Magelan. Inoltre viene attivata la sirena collegata. Nello stesso tempo, ogni Smartphone registrato riceve una notifica push.
- Il cavo è lungo 2 metri.
- non ci sono problemi di tensione elettrica, grazie alla alimentazione a batteria della durata di 10 anni.
- Insieme con il Gateway GT-100.
- Protezione dati: tutti i dati vengono archiviati esclusivamente nel proprio Gateway personale.

## Applicazione

Per monitorare stanze umide, cantine o la parte sottostante di lavatrici e lavastoviglie. Utilizzabile in combinazione con la principale protezione dall'acqua Magelan e la sirena Magelan. in connessione con il Gateway GT-100.

Per il rapido rilevamento di perdite di acqua indesiderate, in modo da evitare danni maggiori causati dall'acqua.

### Comunicazione ad alta frequenza

- blossom-ic RF: 2.4Ghz, banda ISM, 16 canali.
- Intervallo: fino a 50m negli edifici.





N. art. B-MHP-3970

## Caratteristiche

- Per monitorare la linea principale dell'acqua.
- In uso con i sensori per le perdite Magelan .
- La sirena Magelan può essere collegata anche come segnale acustico di avvertimento.
- Ogni tradizionale valvola a sfera elettromotrice (230 V) può essere collegata al sistema di protezione linea principale acqua Magelan.
- Ripetitore per il sistema blossom-ic.
- Insieme con il Gateway GT-100.
- Protezione dati: tutti i dati vengono archiviati esclusivamente nel proprio Gateway personale.

## Dati tecnici

### Magelan sistema di protezione linea principale acqua

• Temperatura ambiente	0 ~ 50°C
• Umidità ambiente	90 % (senza condensa)
• Tensione di rete	230V AC / 50/60Hz
• Dimensioni	L86 x L86 x A44 (mm)
• Frequenza wireless	2.4GHz, banda ISM, 16 canali
• Classe/tipo di protezione	IP 30
• Test RF	RED 2014/53/EU
• CE	disponibile
• RoHs	disponibile
• Tipo antenna	Antenna PCB

## Applicazione

Monitoraggio permanente della linea principale dell'acqua. in connessione con il Gateway GT-100.

Dopo che i sensori di perdite Magelan segnalano l'ingresso o la perdita di acqua, la linea principale dell'acqua viene chiusa immediatamente. Una tradizionale valvola elettromotrice (230 V) viene collegata al protettore della linea acqua principale Magelan. Tramite la tecnologia radio blossom-ic e l'app, è possibile anche la chiusura e l'apertura della linea dell'acqua principale da remoto in qualsiasi momento.

### Comunicazione ad alta frequenza

- blossom-ic RF: 2.4Ghz, banda ISM , 16 canali.
- Intervallo: fino a 50m negli edifici.





N. art. B-ASD-3984

## Dati tecnici

### Magelan Presa app

• Temperatura ambiente	0 ~ 50°C
• Umidità ambiente	90 % (senza condensa)
• Tensione di rete	230V AC / 50/60Hz
• Dimensioni	L10 x L62 x T73 (mm)
• Frequenza wireless	2.4GHz, banda ISM, 16 canali
• Ampere	max. 10A
• Watt	2000W
• Classe/tipo di protezione	IP 30
• Test RF	RED 2014/53/EU
• CE	disponibile
• RoHs	disponibile
• Tipo antenna	Antenna PCB

## Caratteristiche

- Controllo di tutti i dispositivi elettrici con presa di rete 230 V.
- Tramite l'App dedicata Blossom, da smartphone e tablet è possibile impostare le fasce orarie di riscaldamento
- Ripetitore per il sistema blossom-ic.
- Insieme con il Gateway GT-100.
- Protezione dati: tutti i dati vengono archiviati esclusivamente nel proprio Gateway personale.

## Applicazione

Offre la possibilità di controllare i dispositivi elettronici con cavo di rete tramite app. In connessione con Gateway GT-100.

Consente il risparmio sui costi di elettricità.

Offre la possibilità di programmare i tempi di accensione e spegnimento dei dispositivi, al fine di simulare la presenza all'interno dei locali e scoraggiare potenziali ladri.

### Comunicazione ad alta frequenza

- blossom-ic RF: 2.4Ghz, banda ISM , 16 canali.
- Intervallo: fino a 50m negli edifici.



## LISTINO PREZZI

CODICE	DESCRIZIONE	LISTINO BB 01
B-APTS-3980	Avalon+ Tre Set KIT	852,71
B-ACSE-3979	Avalon Combo+ KIT	340,66
B-HPPS-4070	Hera+ Primus PRO Tre set KIT	1.604,73
1803S22502	Collettore premontato 2 att. completo di coppia valv. a sfera, term. e strumentazione per gestione domotica	792,28
1803S22503	Collettore premontato 3 att. completo di coppia valv. a sfera, term. e strumentazione per gestione domotica	883,27
1803S22504	Collettore premontato 4 att. completo di coppia valv. a sfera, term. e strumentazione per gestione domotica	974,35
1803S22505	Collettore premontato 5 att. completo di coppia valv. a sfera, term. e strumentazione per gestione domotica	1.062,10
1803S22506	Collettore premontato 6 att. completo di coppia valv. a sfera, term. e strumentazione per gestione domotica	1.152,23
1803S22507	Collettore premontato 7 att. completo di coppia valv. a sfera, term. e strumentazione per gestione domotica	1.632,65
1803S22508	Collettore premontato 8 att. completo di coppia valv. a sfera, term. e strumentazione per gestione domotica	1.723,17
1803S22509	Collettore premontato 9 att. completo di coppia valv. a sfera, term. e strumentazione per gestione domotica	1.811,08
1803S22510	Collettore premontato 10 att. completo di coppia valv. a sfera, term. e strumentazione per gestione domotica	1.901,33
1803S22511	Collettore premontato 11 att. completo di coppia valv. a sfera, term. e strumentazione per gestione domotica	1.991,65
1803S22512	Collettore premontato 12 att. completo di coppia valv. a sfera, term. e strumentazione per gestione domotica	2.081,88
B-AS-3555	Magelan Set KIT	su richiesta
B-ACS-3556	Magelan Combo Set KIT	su richiesta
B-TS-3554	Tarus Set KIT	su richiesta
B-GS-3996	Gateway GT-100 Unità di controllo centrale	297,81
B-AP-3977	Avalon+ Testa Termostatica radio con display touch screen	233,53
B-C-3552	Avalon Testa Termostatica radio con display digitale	su richiesta
B-ACPT-3982	Avalon Combo+ Termostato radio	212,10
B-ACST-3978	Avalon Combo+ Attuatore radiatore radio	147,84
B-TST-3748	Tarus String	su richiesta
B-HPPR-4020	Hera+ Primus PRO Barra di connessione radio per sistema a collettore	533,48
B-HEPR-4060	Hera+ Extensia PRO Barra di estensione radio per sistema a collettore	404,94
B-HRTF-4040	Sensore di temperatura per barra connessione radio	10,59
B-HAC-3974	Hera+ Actor Attuatore radio per sistema a collettore	62,13
B-HPT-3975	Hera+ Termostato radio con display touch screen per sistema a collettore	254,95
B-HDP-3976	Hera+ Direct Termostato radio con display touch screen per sistema a collettore dotato di relè aggiuntivo	297,80
B-N-3549	Hera Direct Termostato radio per controllo attuatori cablati (230 v)	su richiesta
B-A-3544	Magelan Sistema di controllo caldaia	su richiesta
B-AT-3545	Magelan Termostato radio per controllo caldaia con termoregolazione	su richiesta
B-AC-3546	Magelan Combo Termostato radio per controllo caldaia	su richiesta
B-T-3587	Tarus Unità di controllo per colonne montanti	su richiesta
B-TT-3588	Tarus Termostato radio in combinazione con B-T-3587	su richiesta
B-MSI-3968	Magelan Sirena	190,67
B-MJS-3971	Magelan Controllo delle veneziane	su richiesta
B-MSE-3967	Magelan Sensore con funzione antifurto	su richiesta
B-ZR-3997	Magelan Regolatore di pompe di circolazione	212,10
B-MLS-3969	Magelan Sensore rilevatore perdite	212,10
B-MHP-3970	Magelan Protezione linea principale acqua	297,80
B-ASD-3984	Magelan Presa App Ripetitore di segnale	117,86
B-MPCD-4091	Magelan controllore radio circolatore 230	287,17





**Energy saving**



**RISPARMIO ENERGETICO**  
**ENERGY SAVING**









Da destra: Flavio, Piero e Graziano Giacomini

### INNOVAZIONE VALORE RICERCA

Innovazione, valori, ricerca rappresentano i nostri punti fermi, la filosofia che guida tutte le nostre scelte.

Un gruppo industriale guidato dalla famiglia Giacomini nella quale la tradizione e l'esperienza si coniugano con la costante volontà di innovazione.

La Famiglia Giacomini e l'ufficio Ricerca e Sviluppo di IVR hanno partecipato alla creazione e sviluppo del progetto SEAS, una società svizzera che produce macchine per l'estrazione dell'acqua dall'aria e apparecchiature per il risparmio energetico.

### INNOVATION VALUE RESEARCH

Innovation, value, research are our key words, in which our philosophy consists.

The leader of this industrial group is the family Giacomini, well-known for their tradition and experience and always focused on innovation.

The Giacomini Family and IVR Research & Development Department took part to the creation and development of the SEAS project, a Swiss company producing machines which extract water from the air and energy-saving systems.

### ERNEUERUNG WERT FORSCHUNG

Erneuerung, Wert und Forschung sind die Schlüsselwörter, aus denen unsere Philosophie sich besteht.

Der Geschäftsleiter dieser Industriegruppe ist die Familie Giacomini, berühmt für seine Tradition und Erfahrung, immer konzentriert auf Erneuerung.

Die Familie Giacomini zusammen mit der Abteilung von Forschung & Entwicklung von IVR haben sich an dem Projekt von SEAS beteiligt, eine Firma, die Maschinen, die Wasser aus Luft gewinnen und Systeme für Energieeinsparung produziert.

### INNOVATION VALEUR RECHERCHE

Innovation, valeur et recherche sont les mots clés qui constituent notre philosophie.

Ce groupe industrielle est dirigé par la famille Giacomini, renommée pour sa tradition et expérience avec une constante désir d'innovation.

La Famille Giacomini et le département de Recherche & Développement de IVR ont participé à la création et au développement du projet SEAS, une société Suisse, producteur de machines qui extraient eau de l'air et systèmes pour l'économie d'énergie.

### ИННОВАЦИИ ЦЕННОСТИ ИССЛЕДОВАНИЯ

Инновации, ценности, исследования - наши сильные стороны, это философия, которая направляет нас на правильные ориентиры.

Инженерно-техническая группа исследователей во главе с семьей Джакomini придерживаются традициям постоянного сочетания опыта с стремлением к инновациям.

Семья Джакomini и отдел исследований и разработок IVR участвовали в создании и развитии проекта SEAS, швейцарской компании, которая производит машины для извлечения воды из воздуха а также оборудования для энергосбережения.



[www.seas-sa.com/water-in-the-air-in-the-world/](http://www.seas-sa.com/water-in-the-air-in-the-world/)



## AWA Building Integration Machine AIR TO WATER with GREEN ENERGY SAVING Solution



### Soluzioni Eco-sostenibili SEAS

Produzione di acqua dall'aria di elevata qualità:



#### BASIC:

Acqua per uso irrigazione, lavaggi, allevamenti, utilizzi industriali, ecc.



#### DRINKING:

Acqua dall'aria potabile, mineralizzata, di elevata qualità, comparabile alle migliori acque in bottiglia



#### MINERAL FREE – FREE PLUS

Consente di ottenere acqua distillata da 2 MΩ a 15 MΩ per uso nei processi industriali, ecc.

### ++Green Energy Saving ++

Con la tecnologia SEAS le Macchine AWA Modula e AWA BIM è possibile inoltre ottenere contemporaneamente a costo zero:

- Con AWA Modula da 250 a 10,000 lt/gg a 30°C/70% H.R.:
  - + Recupero del calore per riscaldamento e/o acqua sanitaria
  - + Recupero dell'aria fresca e secca come fonte primaria per il condizionamento
- AWA BIM da 500 a 2,000 lt/gg a 30°C/70% H.R.:
  - + Ventilazione Meccanica Controllata
  - + Riscaldamento acqua sanitaria e/o riscaldamento



Il saving economico SEAS permette un ROI < ai 2 anni → con utili di esercizio per min. 10 anni.

## AWA BIM Building Integration Machine



Sistema integrato per la produzione di **ACQUA dall'ARIA RECUPERO TERMICO** attivo per impianti di ventilazione

È un sistema pensato per essere integrato nei building: residenziali, industriali, palestre, piscine, fabbriche, ecc. che

**Fornisce in contemporanea a basso costo:**

- ❖ Ventilazione meccanica controllata in temperatura ed umidità.
- ❖ Riscaldamento dell'acqua sanitaria e/o per riscaldamento.
- ❖ Produzione di acqua dall'aria di alto livello.
- ❖ Potabilizzazione e mineralizzazione dell'acqua prodotta e/o da altri fonti di approvvigionamento. Azzeramento utilizzo bottiglie PET.



Il sistema permette un ritorno economico tale da recuperare velocemente l'investimento con un **Saving / Guadagno importante per oltre 10 anni!**





## AWA Building Integration Machine AIR TO WATER with GREEN ENERGY SAVING Solution



## SEAS Eco-sustainable solutions

### Production of high quality water from air



**BASIC:**  
Water for irrigation, washings, cattle rearing, industrial application, etc.



**DRINKING:**  
High quality drinking water from air, mineralized, comparable to the best bottled water worldwide.



**MINERAL FREE – FREE PLUS:**  
Deminerallized water from 2MΩ to 15 MΩ suitable for industrial application as food, pharmaceutical, cosmetics, etc.

### ++ Green Energy Saving ++

With SEAS technology, AWA MODULA and AWA BIM systems, it is also possible obtain, at the same time, at zero cost:

- With AWA Modula from 250 to 10,000 lt/gg a 30°C/70% humidity:
  - + Heat recovery for heating and / or sanitary water
  - + Fresh and dry air recovery as primary source for conditioning
- With AWA BIM from 500 to 2,000 lt/gg a 30°C/70% humidity:
  - + Controlled Mechanical Ventilation
  - + Sanitary water and / or heating



SEAS' economic saving allows a ROI < 2 years → with profits for min. 10 years.

## AWA BIM Building Integration Machine



Integrated system for **WATER from AIR** production and active **Thermal Energy RECOVERY** for ventilation systems

BIM is a system intended for easy integration in buildings as: residential, industrial, gyms, pools, factories, etc.

### BIM provides at the same time and at low cost:

- ❖ mechanical ventilation controlled in temperature and humidity;
- ❖ domestic water heating and/or building heating;
- ❖ high quality water from air production;
- ❖ purification and mineralization of the produced water and / or water coming from other sources of supplying;
- ❖ Zero PET bottle use.

The system effectiveness permits to repay the investment in a very short time and permits an important saving/gain for over 10 years!



## CONDIZIONI DI VENDITA

**Premessa** - I contratti di vendita stipulati da IVR S.p.A. (di seguito denominata "Azienda") sono regolati dalle presenti condizioni generali di contratto, salvo deroghe risultanti da esplicito accordo scritto ed espressamente approvate per iscritto dall'Azienda. Le presenti condizioni generali di vendita si intendono integralmente lette ed accettate dal compratore con il conferimento dell'ordine di acquisto.



**Ordini** - Gli ordini o gli impegni assunti dai rappresentanti, agenti o altri ausiliari dell'Azienda non hanno in alcun modo potere di vincolare l'Azienda medesima; ne consegue che tutti gli ordini effettuati dai predetti rappresentanti, agenti e ausiliari acquistano validità ed efficacia solo con la conferma scritta dell'Azienda e l'approvazione scritta dell'Ufficio commerciale dell'Azienda. Qualsiasi modifica dell'ordine sarà valida solo previa conferma scritta ed approvazione scritta dell'Ufficio commerciale dell'Azienda. Gli ordini verranno evasi solo per confezioni complete e con importo minimo di 500,00 € netto merce.

**Prezzi** - I prezzi si ritengono validi solo dopo nostra conferma scritta. La merce è venduta ai prezzi del listino in vigore al momento del conferimento dell'ordine.

**Consegna** - Eventuali ritardi dovuti a problemi di fabbricazione compresa mancanza di materie prime, avarie di macchinari, scioperi o forza maggiore non danno alcun diritto al Committente di ritardare i pagamenti, annullare l'ordine confermato o reclamare danni di qualsiasi natura.

**Spedizioni** - La merce normalmente viaggia in Porto Assegnato, quindi a rischio e pericolo del Cliente. Non si risponde degli eventuali ritardi, avarie o ammanchi verificatisi durante il viaggio. Le indicazioni del Committente in ordine al mezzo di spedizione hanno valore di semplice raccomandazione e verranno seguite al limite delle possibilità operative; in caso contrario verrà utilizzato il mezzo disponibile al momento senza alcun avviso.

**Quantità** - Gli ordini verranno evasi solo per confezioni complete.

**Illustrazioni** - Gli articoli nelle forme e colori riportati nei cataloghi sono solo rappresentativi e non vincolanti la produzione alla fedele esecuzione. IVR S.p.A. si riserva il diritto di apportare modifiche di natura tecnica, estetica e commerciale senza alcun obbligo di preavviso.

**Reclami** - Non si accettano reclami trascorsi 5 giorni lavorativi dalla data di ricevimento della merce. I reclami devono essere effettuati per iscritto e recapitati presso la nostra sede.

**Resi** - Non si accettano resi senza la previa autorizzazione scritta dell'Azienda. La merce deve essere resa in Porto Franco nelle medesime condizioni in cui il compratore l'aveva ricevuta.

**Responsabilità** - Tutti i prodotti vengono collaudati prima di essere posti in vendita. Eventuali articoli con difetti di fabbricazione da noi riconosciuti verranno gratuitamente sostituiti dopo aver ricevuto di ritorno in porto franco il pezzo contestato. Non verranno riconosciuti altri indennizzi né rimborsi spese per le conseguenze derivanti dall'impiego, installazioni e sostituzioni di nostri materiali.

**Pagamenti** - La condizione di pagamento è quella indicata in fattura. Trascorse le scadenze convenute, senza alcun avviso, verranno calcolati gli interessi di mora, secondo il tasso vigente. Eventuali spese bancarie verranno addebitate al cliente.

**Forniture di prodotti OEM / Speciali / Personalizzati** - Qualora oggetto della vendita siano prodotti riportanti un marchio di proprietà del Cliente, quest'ultimo deve garantire la piena e incondizionata titolarità del marchio stesso e autorizzare IVR S.p.A. a utilizzare il marchio al fine di realizzare i prodotti oggetto della fornitura. Il Cliente si impegna a manlevare e tenere indenne IVR S.p.A. da ogni e qualsiasi pretesa o azione anche di terzi al riguardo. È onere e responsabilità esclusiva del Cliente determinare e comunicare le caratteristiche tecniche e le informazioni da riportare sulla confezione del prodotto finito, con espresso riferimento, tra l'altro, a eventuali normative, regolamenti, prassi e usi locali o internazionali in merito all'origine, alla provenienza, alle caratteristiche tecniche dei prodotti e alla tracciabilità degli stessi, ecc. Il Cliente si impegna a manlevare e tenere indenne IVR S.p.A. da ogni e qualsiasi pretesa o azione di terzi al riguardo o da sanzioni eventualmente irrogate in conseguenza del mancato o inesatto ottemperamento a quanto sopra previsto.

Il prezzo di vendita dei prodotti OEM al Cliente sarà quello indicato di volta in volta nella conferma d'ordine inviata da IVR S.p.A. per la singola fornitura; eventuali listini o offerte inviati hanno unicamente valore indicativo e non sono in alcun modo vincolanti per IVR S.p.A.

Resta inteso che il Cliente si impegna a ritirare tutti i prodotti ordinati e realizzati con il proprio marchio, IVR S.p.A. sarà autorizzata a fatturare gli stessi trascorso il termine di 90 giorni dalla messa a disposizione della merce.

**Controversie** - Il foro competente è sempre e solo quello di Novara.



## GENERAL SALES CONDITIONS



**Introduction** - The sales contracts stipulated by IVR S.p.A. (hereinafter the "Company") are governed by these general terms and conditions, unless exceptions resulting from explicit written agreement approved in writing by the Company. These general conditions of sale are considered fully read and accepted by the buyer with the confirmation of the purchase order.

**Orders** - Orders taken by representatives, agents or other auxiliary of the Company does not in any way have authority to bind the company itself; all orders made by the above mentioned representatives, agents and auxiliaries become valid and effective only with the written confirmation of the Company. Any modification of the order will be valid only after written confirmation and written approval of the Company. Orders will be processed only for complete box packages and with goods minimum amount of 500,00 € net.

**Price** - Prices are validated by our written confirmation. Goods are sold according to the price list in use on the order date.

**Transport** - Delay due to manufacturing problems including lack of raw materials, machinery breakdowns, strikes or force majeure do not give any right to the customer to delay payments, cancel orders already confirmed or claim damages of any kind.

**Delivery** - The goods are transported at the Purchaser's own risk. IVR will not accept to be held responsible for delays, malfunctions and damage occurred during the transport of the goods. The Purchaser's indications regarding the means of transport to be used are to be considered as suggestions and will be followed as precisely as possible; if not the most convenient alternative will be used without prior notice.

**Quantity** - Ordered goods will be dispatched according to complete box quantities.

**Pictures** - The pictures of the items in the catalogue are purely representative of the product, variations can take place in any moment. IVR S.p.A. reserves the right to make technical changes, aesthetic and commercial without any prior notice.

**Claims** - Complaints are not accepted after 5 working days from the date of receipt of goods. Claims must be made in writing and delivered at our address.

**Returns** - Returns of goods are not accepted without the prior written permission of the Company. The goods must be delivered DAP at the Company address and must be un-used and in good conditions.

**Liability** - All goods undergo a quality test before being sold. In case of proved defects admitted by IVR, goods will be replaced without additional costs after authorized receipt of the faulty goods. No additional costs, such as any kind of refund due to damage, caused by the faulty goods or installations and replacement expenses, will be accepted.

**Payment** - The condition of payment is indicated in the invoice. After the expiry date, without any warning, interest will be calculated according to the rate in force. In case of bank charges, these will be billed to the customer.

**Supplies of OEM / Special / Customized products** – If the subject of the sale are products bearing a trademark owned by the client, the latter shall ensure the full and unconditional ownership of the trademark and authorize IVR S.p.A. to use the trademark in order to make the products to be supplied. The Customer agrees to indemnify and hold harmless IVR S.p.A. from any and all third party claims or actions in the regard.

It is Customer's liability and sole responsibility to determine and communicate the technical specifications and the information on the packaging of the finished products, with the specific reference to any laws, regulations, practices and local or international custom about origin, provenance, product specification and traceability of the same, etc... The Customer agrees to indemnify and hold harmless IVR S.p.A. from any and all claims or actions of third parties in this regard or any penalties applied as a result of failure or incorrect application to the above.

The price of OEM products will be shown in the order confirmation sent by IVR S.p.A. and are related just to a specific delivery and does not bind IVR S.p.A. for longer periods, unless a different agreement is in place.

It is understood that the Customer agree to collect all OEM products ordered and manufactured, IVR S.p.A. will be entitled to invoice the same after 90 days from the provision of goods.

**Disputes** - Disputes will be settled by the court of Novara.

## CONDIZIONI DI GARANZIA

### GENERAL WARRANTY CONDITIONS

I prodotti fabbricati da IVR S.p.A. sono garantiti per due anni dalla data di spedizione dai propri stabilimenti. La presente garanzia si aggiunge e non pregiudica i diritti dell'acquirente previsti dalla Direttiva Europea 99/44/CE e relativo decreto nazionale di attuazione, salvo in casi ove diversamente specificato.



Sono esclusi dalla presente garanzia, i guasti e gli eventuali danni causati da:

- **Trasporto non effettuato a cura dell'Azienda.**
- **Inosservanza delle istruzioni e delle avvertenze previste dal produttore e riportate sui manuali, istruzioni e/o cataloghi dei prodotti.**
- **Inosservanza di norme e/o disposizioni previste da leggi e/o regolamenti vigenti.**
- **Assenza o difetto di manutenzione periodica, trascuratezza, incapacità d'uso, manomissioni.**
- **Errata installazione e/o anomalie di qualsiasi genere nell'alimentazione degli impianti idraulici, elettrici, di erogazione del combustibile e/o scarichi.**
- **Inadeguati trattamenti dell'acqua di alimentazione, trattamenti disincrostanti erroneamente effettuati.**
- **Corrosione causata dall'aggressività dell'acqua o da condensa.**
- **Gelo, correnti vaganti, e/o effetti dannosi di scariche atmosferiche.**
- **Sostituzioni preventive.**
- **Cause di forza maggiore indipendenti dalla volontà e dal controllo dell'Azienda produttrice.**

Gli eventuali difetti nei materiali, o vizi occulti, come pure gli errori, le differenze nelle dimensioni eccedenti le normali tolleranze di fabbricazione impegneranno l'Azienda alla sola sostituzione dei pezzi difettosi.

Eventuali resi di merce non conforme verranno accettati solo con preventiva autorizzazione scritta (autorizzazione al reso) da parte dei Responsabili Commerciali dell'Azienda. In ogni caso la merce resa dovrà pervenire presso gli stabilimenti dell'Azienda in porto franco. Diversamente la merce sarà respinta al mittente.

Ogni eventuale reso di materiale conforme deve essere preventivamente concordato con la Direzione Commerciale dell'Azienda. I costi di trasporto saranno a carico del cliente.

La copertura assicurativa ha durata di dieci anni dalla data di spedizione dagli stabilimenti dell'Azienda.

Solo nel caso di messa in opera di prodotti non conformi dell'Azienda e di danni a persone o a cose involontariamente causati da questi, essa incaricherà la propria Compagnia d'Assicurazione di procedere a norma di polizza. Per aprire il sinistro con la Compagnia d'Assicurazione, l'Azienda deve ricevere denuncia del sinistro entro 10 giorni dall'evento, pena il mancato risarcimento, e tutti i dati dello stesso su apposito questionario con allegati documenti e campioni necessari per la gestione della pratica di risarcimento, entro termine di 30 gg.

Nessun rimborso sarà riconosciuto al Cliente prima che l'Azienda abbia verificato la causa del reclamo e/o del danno.

Nel caso in cui siano necessari o richiesti dei test di laboratorio per la verifica, ricerca, definizione della non conformità di un reso/reclamo/sinistro, ove la stessa non risultasse imputabile a responsabilità dell'Azienda, i costi sostenuti saranno addebitati al richiedente. Gli installatori devono effettuare e documentare le prove sugli impianti secondo le normative internazionali vigenti, in Italia come prescritto dal DM 37/08, e la norma UNI 9182.

Any product produced by IVR S.p.A. is covered by a 2 year warranty from the delivery date from the factory. This warranty is an addition, and does not affect the buyer's rights under the European Directive 99/44/CE and the related national implementing decree, except where otherwise noted.



We exclude from this warranty defects and damage caused by:

- **Transport not arranged by the Company.**
- **Failure to comply with the instructions and warnings provided by the manufacturer and found in the manuals, instructions and/or product catalogs.**
- **Disregard of standards and/or provisions of laws and / or regulations.**
- **Absence, or lack of, maintenance, neglect, inability to use, tampering.**
- **Incorrect installation and/or anomalies of any kind in supplying plumbing, electrical, fuel dispensing and/or draining systems.**
- **Corrosion caused by aggression or water condensation.**
- **Frost, stray currents, and/or harmful effects of lightning and storms.**
- **Preventive replacements.**

In case of material defects, or hidden faults, as well as mistakes or differences in dimensions exceeding normal manufacturing tolerances, the Company will only replace the faulty pieces.

Any eventual return of non-conforming goods will be accepted only against a prior written authorization by Commercial Directors ("Return Authorization"). In any case the returned goods shall have to reach the Company's warehouse free of any transport costs, otherwise the goods will be rejected and returned to the sender.

Any return of compliant material must have first been agreed with the Company's Business/Sale Management. Customers shall pay for freight costs. Insurance cover lasts ten years from the delivery date from our factory.

In case the Company's installed non-conforming products accidentally caused damage to things or people, the Company will call upon its Insurer in order to treat the accident according to its policy. To be able to start the claim with the Insurance, the Company must receive the complaint form within 10 days of the accident occurring, or a non-compensation penalty will apply. A specific questionnaire must be duly filled within 30 days, including all the accident details, relevant documentation, and samples of the faulty articles which are necessary to complete the compensation file.

No reimbursement will be allowed until the Company has verified the causes of claim and/or damage.

Should laboratory tests become necessary, the costs incurred whilst checking and defining the non conformity of a claim or return or damage, will be charged to the customer, if the fault can't be attributed to the Company.

The installers must perform and document tests on systems in accordance with international regulations in force in Italy as required by the law DM 37/08 and the regulation UNI 9182.



AL MOMENTO DELL'ORDINE SI PREGA DI INDICARE SEMPRE IL CODICE ARTICOLO



\* Disponibile su richiesta | Confezione: □ quantità per scatola - ☒ quantità per cartone | I prezzi si riferiscono al singolo pezzo

**ASSORTIMENTI, CARATTERISTICHE E PREZZI DEI PRODOTTI POSSONO ESSERE SOGGETTI A VARIAZIONI SENZA PREAVVISO**

#### **SERVOCOMANDI E VALVOLE MOTORIZZABILI**

IMPIEGHI: Impianti di riscaldamento a zone - impianti di refrigerazione con glicole - impianti industriali e di irrigazione

#### **VALVOLE ACQUA**

Ref.: Articoli | Valvola a sfera in ottone sgrassata per ossigeno: aumento prezzo 5% | Valvola a sfera con filettatura NPT: aumento prezzo 10% | Valvola a sfera con maniglia in DACROMET: aumento prezzo 3%

#### **VALVOLE GAS**

Ref.: Articoli 82-83 | Valvola a sfera flangiata in ghisa con O-RING in VITON: disponibile su richiesta

#### **VALVOLE INDUSTRIA**

Ref.: Articoli 77-78-80-81 | Valvola a sfera flangiata in ghisa con O-RING in VITON: disponibile su richiesta

Ref.: Articoli INOX | Valvola con filettatura NPT: disponibile su richiesta

Ref.: Articoli - ATTUATORI ELETTRICI | Su richiesta alimentazione a 60 Hz

Ref.: Articoli - ATTUATORI PNEUMATICI | Tutti gli attuatori MHP DA / SR assemblati sulle valvole sono stati calcolati per utilizzo con pressione 6 bar / 87 p.s.i. | Gli attuatori MHP-SR a semplice effetto sono forniti con 6 molle per ciascun lato delle testate

PLEASE INDICATE ITEM CODE ON ORDERS



\* Available on request | Packaging: □ quantity per box - ☒ quantity per master carton | The prices refer to the single piece

**PRODUCT FEATURES AND PRICES CAN CHANGE WITHOUT NOTICE**

#### **ACTUATORS AND MOTORIZED VALVES**

GENERAL USE: zone heating system - glycol refrigeration system - industrial system general - irrigation system

#### **WATER VALVES**

Ref.: Items | Degreased brass ball valve suitable for oxygen: 5% price increase | Ball valve with threaded ends NPT: 10% price increase | Ball valve with DACROMET handle: 3% price increase

#### **GAS VALVES**

Ref.: Items 82-83 | Cast iron ball valve with VITON O-RING: available on request

#### **INDUSTRY VALVES**

Ref.: Items 77-78-80-81 | Cast iron ball valve with VITON O-RING: available on request

Ref.: Items INOX | Ball valve with threaded ends NPT: available on request

Ref.: Items - ELECTRICAL ACTUATORS | Electrical power supply at 60 Hz available on request

Ref.: Items - PNEUMATIC ACTUATORS | All actuators MHP DA / SR assembled on the valve are calculated for 6 bar / 87 p.s.i. operating pressure | The pneumatic spring return actuators are supplied with six springs on each side of cap.

BEI DER BESTELLUNG BITTE IMMER DIE ARTIKEL-NUMMER ANGEBEN



\* Erhältlich auf Anfrage | Verpackung: □ Menge pro Schachtel - ☒ Menge pro Karton | Die Preise verstehen sich pro Stück

**DIE MERKMALE UND PREISE DER ARTIKEL KÖNNEN OHNE VORANKÜNDIGUNG ÄNDERUNGEN UNTERLIEGEN**

#### **SERVOSTEUERUNGEN UND MOTORISIERBARE KUGELHÄHNE**

VERWENDUNGSGEBIETE: Zonenheizanlagen – Kühlanlagen mit Glykohl – Industrie- und Bewässerungsanlagen

#### **WASSERKUGELHÄHNE**

Ref.: Artikel | Kugelhahn aus Messing, entfettet für Sauerstoff: Aufpreis 5 % | Kugelhahn mit NPT-Gewinde: Aufpreis 10 % | Kugelhahn mit Griff aus DACROMET: Aufpreis 3 %

#### **GASKUGELHAHN**

Ref.: Artikel 82-83 | Flanschkugelhahn aus Gusseisen mit O-RING aus VITON: erhältlich auf Anfrage

#### **INDUSTRIEKUGELHÄHNE**

Ref.: Artikel 77-78-80-81 | Flanschkugelhahn aus Gusseisen mit O-RING aus VITON: erhältlich auf Anfrage

Ref.: Artikel INOX | Kugelhahn mit NPT-Gewinde: erhältlich auf Anfrage

Ref.: Artikel - ELEKTRISCHE ANTRIEBE | Auf Anfrage mit 60 Hz Versorgung

Ref.: Artikel - PNEUMATISCHE ANTRIEBE | Alle mit den Kugelhähne zusammengebauten Antriebe MHP DA / SR wurden für die Anwendung mit einem Druck von 6 bar / 87 p.s.i. bemessen | Die einfachwirkenden Antriebe MHP-SR sind mit 6 Federn pro Kopfseite ausgestattet

LORS DE LA COMMANDE, VEUILLEZ TOUJOURS INDIQUER LE CODE ARTICLE



\* Disponible sur demande | Emballage:  quantité par boîte -  quantité par carton | Les prix se réfèrent à chaque pièce

#### LES CARACTÉRISTIQUES ET LES PRIX DES PRODUITS PEUVENT ÊTRE SOUMIS À DES VARIATIONS SANS PRÉAVIS

##### SERVOCOMMANDES ET VANNES MOTORISABLES

UTILISATIONS : Systèmes de chauffage à zones - systèmes de réfrigération au glycol - systèmes industriels et d'irrigation

##### VANNES EAU

Réf.: Articles | Vanne à boisseau sphérique en laiton dégraissée pour oxygène: augmentation du prix de 5% | Vanne à boisseau sphérique avec filetage NPT: augmentation du prix de 10% | Vanne à boisseau sphérique avec poignée en DACROMET: augmentation du prix de 3%

##### VANNES GAZ

Réf.: Articles 82-83 | Vanne à boisseau sphérique bride en fonte avec O-RING en VITON: disponible sur demande

##### VANNES INDUSTRIE

Réf.: Articles 77-78-80-81 | Vanne à boisseau sphérique bride en fonte avec O-RING en VITON: disponible sur demande

Réf.: Articles INOX | Vanne avec filetage NPT: disponible sur demande

Réf.: Articles - ACTUATEURS ÉLECTRIQUES | Sur demande alimentation à 60 Hz

Réf.: Articles - ACTUATEURS PNEUMATIQUES | Tous les actuators MHP DA / SR assemblés sur les vannes ont été calculés pour une utilisation avec une pression de 6 bars/ 87 p.s.i. | Les actuators MHP-SR à effet simple sont fournis avec 6 ressorts de chaque côté des têtes

ПРИ ЗАКАЗЕ НЕОБХОДИМО УКАЗАТЬ КОД ИЗДЕЛИЯ



\* Под заказ | Упаковка:  Количество в коробке -  Количество в большой коробке | Указанная цена относится к единице изделия

#### ХАРАКТЕРИСТИКИ И ЦЕНА ИЗДЕЛИЯ МОГУТ БЫТЬ ИЗМЕНЕНЫ БЕЗ ПРЕДВАРИТЕЛЬНОГО ПРЕДУПРЕЖДЕНИЯ

##### ЭЛЕКТРИЧЕСКИЕ И ПНЕВМАТИЧЕСКИЕ ПРИВОДЫ

ПРИМЕНЕНИЕ: Системы отопления по зонам – системы гликолевого охлаждения – промышленные и ирригационные системы

##### ЗАПОРНАЯ АРМАТУРА ДЛЯ ВОДЫ

Réf.: Изделия | Латунный шаровой кран без смазки (для кислорода): цена выше на 5% | Шаровой кран с резьбовым соединением NPT: цена выше на 10% | Шаровой кран с ручкой DACROMET: цена выше на 3%

##### ЗАПОРНАЯ АРМАТУРА ДЛЯ ГАЗА

Réf.: Изделия 82-83 | Чугунный шаровой кран с O-кольцом VITON: под заказ

##### ИНДУСТРИАЛЬНАЯ ЗАПОРНАЯ АРМАТУРА

Réf.: Изделия 77-78-80-81 | Чугунный шаровой кран с O-кольцом VITON: под заказ

Réf.: Изделия из нержавеющей стали INOX | Шаровой кран с резьбовым соединением NPT: под заказ

Réf.: Изделия - ЭЛЕКТРОПРИВОДЫ | Электропитание с частотой 60Гц: под заказ

Réf.: Изделия - ПНЕВМОПРИВОДЫ | Все приводы MHP DA / SR, монтируемые на клапаны, рассчитаны для работы с давлением в 6 bar / 87 p.s.i. |

Приводы простого действия поставляются с шестью пружинами на каждой стороне.







